



# Preventing Falls from Ladders in Construction

A Guide to Training Site Supervisors



Harvard School of Public Health, Department of Environmental Health

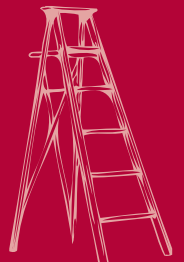



## Preventing Falls from Ladders in Construction



HARVARD  
School of Public Health

Department of Environmental Health  
665 Huntington Avenue  
Boston, MA 02115  
phone 617.432.2610  
fax 617.432.0219

Melissa J. Perry, ScD, MHS, Principal Investigator  
[mperry@hsph.harvard.edu](mailto:mperry@hsph.harvard.edu)  
Christopher J. Ronk, MS, Project Coordinator  
[cronk@hsph.harvard.edu](mailto:cronk@hsph.harvard.edu)

©2010, HSPH - Harvard School of Public Health. All rights reserved.

Research for this report was funded by CPWR – The Center for Construction Research and Training, using grant U54 OH008307 from the National Institute of Occupational Safety and Health (NIOSH). The contents are solely the responsibility of the authors and do not necessarily represent the official views of NIOSH, HSPH, or CPWR.

The cover photo shows an example of a worker accessing a ladder safely.

Photo credit: NIOSH/John Rekus/elcoshimages.org





## Table of Contents

<b>Ladder Safety Study</b> .....	<b>7</b>
About This Manual .....	7
Ladder Safety Rationale .....	7
Focus on Ladders and Superintendents .....	7
Theory and Conceptual Foundation .....	7
Intervention Learning Objectives for Superintendents.....	8
Ladder Safety Study Design .....	10
Ladder Safety Study Results .....	10
Ladder Safety Study Investigators and Advisors.....	11
Research Presentations and Articles Originating from the Study.....	11
<b>Module I: Ladder Falls Knowledge</b> .....	<b>13</b>
<b>Module II: Personal Susceptibility</b> .....	<b>17</b>
<b>Module III: Peer Norms</b> .....	<b>20</b>
<b>Module IV: Skills Training</b> .....	<b>21</b>
<b>Appendices</b> .....	<b>27</b>
Appendix 1: Proper Ladder Setup Dimensions .....	27
Appendix 2: Ladder Safety Knowledge Questions .....	28
Appendix 3: Guidelines for Extension Ladder Safety .....	30
Appendix 4: Combined Results of All Sites of Companies Visited .....	32
Appendix 5: Communication Skills Case Vignette .....	37



# Ladder Safety Study

About This Manual  
Ladder Safety Rationale  
Focus on Ladders and Superintendents  
Theory and Conceptual Foundation  
Intervention Learning Objectives for Superintendents  
Ladder Safety Study Design  
Ladder Safety Study Results  
Ladder Safety Study Investigators and Advisors  
Research Presentations and Articles Originating from the Study

## About This Manual

This manual has two objectives. The first is to describe how the Ladder Safety Study was conducted and to present the results. The second is to provide the Intervention Program content and supporting materials as a guide for safety practitioners who would like to conduct an effective ladder-training session.

## Ladder Safety Rationale

The goal of this study was to reduce the incidence of falls from portable construction ladders. The project built on prior and ongoing surveillance efforts on ladder-related injuries by moving the research into the development and evaluation of interventions. There are still many unknowns about falls in construction, and the most effective approaches to preventing falls from ladders are not yet clear. We conducted a two-stage study undertaking pre-intervention research to develop an intervention plan based on sound scientific evidence and following it by implementing a program to evaluate both its feasibility and success in increasing knowledge and safety behaviors.

## Focus on Ladders and Superintendents

Our focus on ladders was intended to be a highly directed approach targeting a well-known source of falls. Including a specific focus on step ladders addressed a commonly overlooked special context for injury. Both worksites and workers were intervention targets; however, our primary aim was to not employ the usual “change the worker” approach to injury prevention but rather to target work-specific and jobsite-specific contexts that can increase risk of falls. Because superintendents exert major influences over their worksites, we assumed that increasing their knowledge and changing their attitudes and risk perceptions would also have an impact on their workers. The superintendents would serve as positive models for safety behavior and high-risk ladder work substitution.

## Theory and Conceptual Foundation

To achieve behavior change, we focused on several factors known to influence health behavior change (Bunton et al., 1991). These factors have been shown to be influential in many other health promotion programs. However, to the best of our knowledge, this was the first project to apply these concepts to construction injuries.

Knowledge of the risks associated with health-compromising behaviors has been identified as necessary but not sufficient to result in behavior change (Edwards et al., 1990). Risk perception, a belief in one’s susceptibility for disease or injury, has also been identified as a necessary prerequisite for changing health behaviors (Weinstein, 1987). An individual’s perception of peer norms, which define the perceived acceptability of a behavior among friends and peers, influences whether someone will practice safer behaviors (Rogers, 2003). Self-efficacy beliefs or beliefs in one’s ability to make the behavior change are also highly predictive of actual behavior change (Bandura, 1986).



## Intervention Learning Objectives for Superintendents

Our safety training for superintendents emphasized: a) major sources and contexts for falls from portable ladders in the workplace (hazards); b) strategies to routinely identify worksite-related ladder hazards; c) strategies to routinely identify job-related ladder hazards; d) ways to replace high-risk ladder work tasks with lower risk alternatives (e.g., bucket hoists and scaffolding); and e) strategies to teach and model safety behavior to workers. We emphasized ways to organize work to reduce high-risk tasks, to communicate hazard information to workers without lecturing them, and to model safety knowledge and behavior by using “I” statements that illustrate how one incorporates safety tips into work practices (e.g., “I have learned one of the best ways to stay safe on the ladder is to always maintain three points of contact.”). Worksite superintendents, given the many demands on them, do not always consider safety as their first priority. They need training to raise their awareness and perceived risk of ladder injuries before they are ready to train and model skills to their workers. Therefore, the rationale for ladder awareness was built using the following intervention components:

*I. Knowledge of ladder-associated risks (p. 13).* Current statistics on injuries and falls in construction have been summarized into a presentation designed for nonscientific audiences. It highlights epidemiologic data on fatal and nonfatal severe ladder injuries and what is currently known about fall prevention in general. For example, nearly one quarter of nonfatal falls in construction are related to ladder use, and 38% of

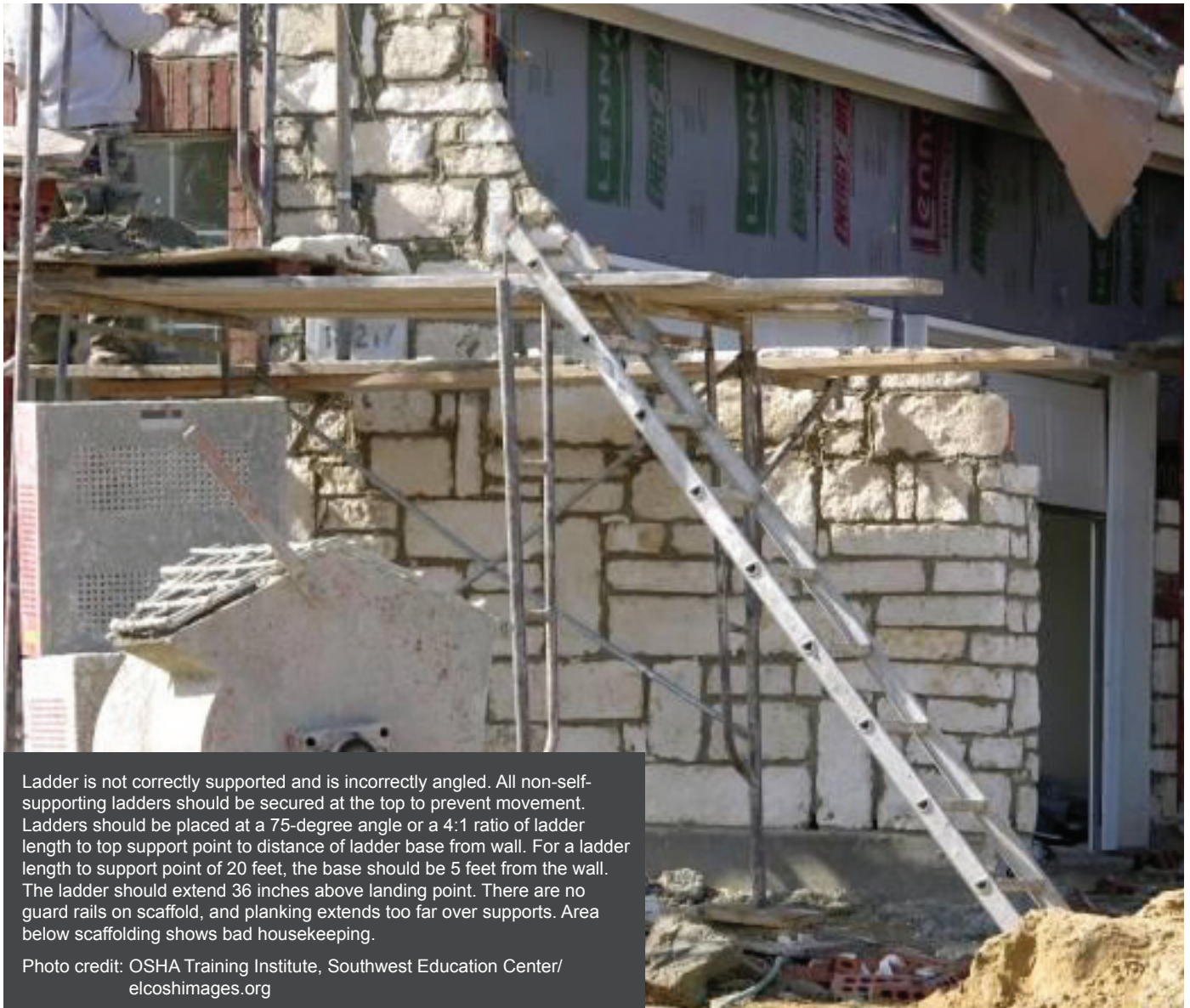

Ladder is not correctly supported and is incorrectly angled. All non-self-supporting ladders should be secured at the top to prevent movement. Ladders should be placed at a 75-degree angle or a 4:1 ratio of ladder length to top support point to distance of ladder base from wall. For a ladder length to support point of 20 feet, the base should be 5 feet from the wall. The ladder should extend 36 inches above landing point. There are no guard rails on scaffold, and planking extends too far over supports. Area below scaffolding shows bad housekeeping.

Photo credit: OSHA Training Institute, Southwest Education Center/  
elcoshimages.org



construction fatalities are due to falls, compared to only 15% in general industry (CPWR, 2008; Bureau of Labor Statistics, 2007). In this presentation we also emphasize the results from our pre-intervention research, including our study of ladder falls treated in emergency rooms (Brennan et al., 2008) and the worksite observations we conducted at 18 sites in eastern Massachusetts. This information was new to most participants in our study, and we presented it to heighten awareness and risk perception.

*II. Susceptibility to ladder hazards (p. 17).* Slides illustrating common ladder-handling problems were shown to superintendents in order to give concrete examples of how hazards occur, how to identify them, and lower risk alternatives to high-risk ladder work tasks. Presented in conjunction with the statistics and epidemiology of ladder falls, this information was intended to increase motivation to practice safe ladder handling routines and vigilance in identifying worksite hazards. The CPWR video, *Don't Fall for It!* (2006), details real-life stories of fall experiences and was also used to heighten awareness of injury susceptibility.

*III. Peer norms for safe ladder handling (p.20).* We discussed how respected local companies have altered their job routines to avoid doing high-risk job tasks on ladders, to incorporate safe ladder handling into their job routines, and to communicate this information to the workers they oversee. This component of the intervention assumed that using well-regarded members of a peer group (i.e., managers in a shared trade and work region) to model the desired behavior change (i.e., reduce reliance on ladders and switch to lifts) would encourage behavior change among the superintendents. The discussion included an overview of current industry standards and examples of how the new practices introduced by some companies to reduce ladder risks may be changing safety norms throughout the construction industry.

*IV. Skills training to increase self-efficacy beliefs (p. 21).* The training included time spent reviewing specific practices that can decrease ladder hazards—including the Three Points of Contact Rule and the Belt Buckle Rule—to teach specific skills that superintendents can communicate to and reinforce with

workers. One objective of this component of the session was to give superintendents time to acquire the skills necessary to practice safe ladder handling procedures so that they could model them to their workers. If the superintendents perceived they had learned some new skills, self-efficacy beliefs for safe ladder handling were likely to increase as well. The other key objective was to give superintendents an opportunity to practice alternative forms of communication to guide workers rather than alienate them.



Ladder is placed incorrectly. If possible, worker should be facing operation. This is an unsafe, awkward work posture.

Photo credit: NIOSH/John Rekus/elcoshimages.org

## Ladder Safety Study Design

The following diagram explains how the Ladder Safety Study was designed:

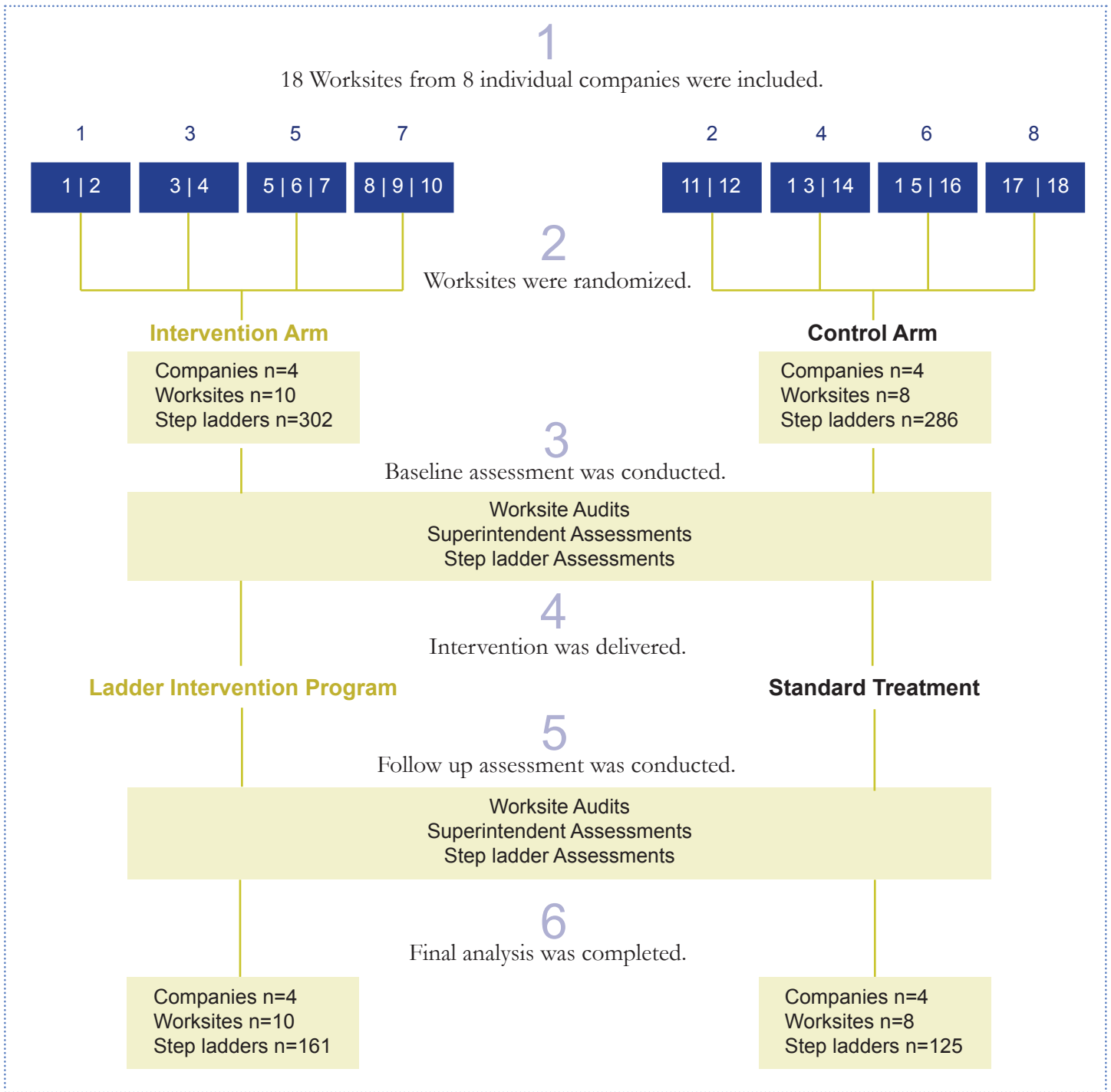

## Ladder Safety Study Results

The intervention program resulted in many positive outcomes. The number of superintendents who intended to promote ladder safety increased, and the post-intervention worksite audits showed that the number of hazards observed decreased. Furthermore, the intervention program resulted in successful increases in the use of scissor lifts relative to step ladders. Superintendents participating in the intervention program said they found the material informative and useful in their day-to-day management responsibilities.

## Ladder Safety Study Investigators and Advisors

---

### Investigators

Melissa J. Perry ScD, MHS, Principal Investigator, Harvard School of Public Health  
Christopher J. Ronk, MS, Project Coordinator, Harvard School of Public Health  
Jack T. Dennerlein, PhD, Co-Investigator, Harvard School of Public Health  
David A. Lombardi, PhD, Co-Investigator, Liberty Mutual Research Institute  
Gordon Smith, MD, Co-Investigator, Liberty Mutual Research Institute

### Expert Panelists and Study Advisors

Ted Christensen, CSP	Liberty Mutual Research Institute
Janie Gittleman, MRP, PhD	CPWR – The Center for Construction Research and Training
Alan D. Kline	Lynn Ladder and Scaffolding Co.
Erick H. Knox PhD, PE	Engineering Systems Inc.
G.T. Lineberry, PhD	University of Kentucky
Michael McCann, PhD, CIH	CPWR – The Center for Construction Research and Training
David P. Powell	Associated General Contractors of Massachusetts
Ted Scharf, PhD	National Institute of Occupational Safety and Health (NIOSH)
Mary Vogel, JD	The Construction Institute (TCI)
William J. Wiehagen, MSIE, CMSP	National Institute of Occupational Safety and Health (NIOSH)
Christopher Ziegler	Associated General Contractors of Massachusetts

## Research Presentations and Articles Originating from the Study

---

- Brennan M, Lombardi D, Smith GS, Courtney T, Young J, Dennerlein J, Perry MJ. Falls from ladders: Preliminary results from a case-crossover study of emergency room cases. Presented at the 18th Annual Construction Safety and Health Conference and Exposition, Rosemont, IL, February 12-14, 2008.
- Dennerlein JT, Ronk CJ, Perry MJ. Portable ladder assessment tool development and validation – quantifying best practices in the field. Presented at the 18th Annual Construction Safety and Health Conference and Exposition, Rosemont, IL, February 12-14, 2008.
- Dennerlein JT, Ronk CJ, Perry MJ. Portable ladder assessment tool development and validation – quantifying best practices in the field. *Safety Science* 2009; 47(5):636-39.
- Ronk CJ, A Cluster-Randomized Trial with General Construction Superintendents to Mitigate Step ladder-Related Fall Hazards. Doctoral Dissertation. Harvard School of Public Health, 2010.
- Ronk CJ, Dennerlein JT, Perry MJ. Prevalence of hazards associated with falls from construction stepladders. Proceedings of the NORA Young/New Researcher Symposium, Salt Lake City, UT, July 2008.
- Ronk CJ, Dennerlein JT, Perry MJ. Prevalence of hazards associated with falls from step ladders and targets for intervention. National Occupational Injury Research Symposium, Pittsburgh, PA, October 2008.
- Smith GS, Lombardi DA, Corns H, Courtney TK, Dennerlein JT, Dong X, Perry MJ. The impact of age on the relative risk of mortality from work-related ladder falls compared to other types of occupational injuries in the US. Proceedings of the International Conference on Slips, Trips and Falls 2007: From Research to Practice, Hopkinton, MA, August 22-23, 2007.
- Smith GS, Lombardi DA, Corns H, Courtney TK, Dennerlein JT, Dong X, Perry MJ. Relative risks of ladder fatalities increase precipitously by age compared to other work fatalities in the US. Presented at the American Public Health Association Annual Meeting, Washington DC, November 2007.



# I. Ladder Falls Knowledge

## LEARNING OBJECTIVES

The goal of this education module is to teach construction company supervisors, foremen, and other managerial level personnel to understand:

- Types of ladders
- Components of ladder use
- Major risk factors associated with ladder falls

This section leads off with specifics about ladder setup and use.

### Ladder Setup Details

We reviewed the key technical aspects of ladder use—ladder dimensions, positioning, and core knowledge—with the superintendents in our study. Appendix 1 provides the appropriate dimensions and positioning for ladder setup. Appendix 2 is a questionnaire given to the superintendents to determine their understanding of ladder safety. Appendix 3 details safety guidelines for the use of extension ladders.

This section can be customized to meet the specific needs of a group. It may be useful to review the core knowledge questions in Appendix 3 with participants in order to gauge their knowledge levels. Leaders can then adjust the curriculum accordingly.

See  
Appendices

1-3

### Manufacturer Specifications

Self- and non-self-supporting portable ladders must be able to handle at least 4 times the maximum intended load. An exception is extra-heavy-duty type 1A metal or plastic ladders; they must be able to sustain at least 3.3 times the maximum intended load.

### Worksite Observations

In Fall 2007, as part of the baseline assessment for the Ladder Safety Study, we visited eight construction companies in Massachusetts. Each company had two or three worksites; we observed a total of 18 sites (see Ladder Safety Study Design diagram on p. 10). A handheld worksite audit tool was used to collect information on ladder use; the diagram on the top of page 14 illustrates the design of the tool. Overall, there were 1,151 pieces of equipment: 771 step ladders, 50 extension ladders, 28 job-made ladders, and 302 ladder alternatives. Among the ladder alternatives were portable scaffolds, scissor lifts, aerial buckets, scaffoldings, and ladder jacks. Statistics on all of our observations are provided in Appendix 4. The table below gives a condensed version of the baseline data, showing only the main hazards present for step and extension ladders.

See  
Appendix

4

WORKSITE OBSERVATIONS				STEP LADDERS	
8	COMPANIES				%
18	SITES (2-3 Per Company)			Free of defects	96
771	Step ladders			Spreaders locked	94
50	Extension	166	Portable Scaffolds	Bottom clear	87
28	Job-Made	68	Scissor Lifts	Climbing step ladders	
302	Ladder Alternatives	37	Aerial Buckets	• 3 points of contact	72
		26	Scaffoldings	• Hands-free	46
		1	Ladder Jack	Working on step ladders	
		4	Unknown/Not selected	• Minimum forces	72
				• Faces ladder	69



## WORKSITE AUDIT TOOL DIAGRAM

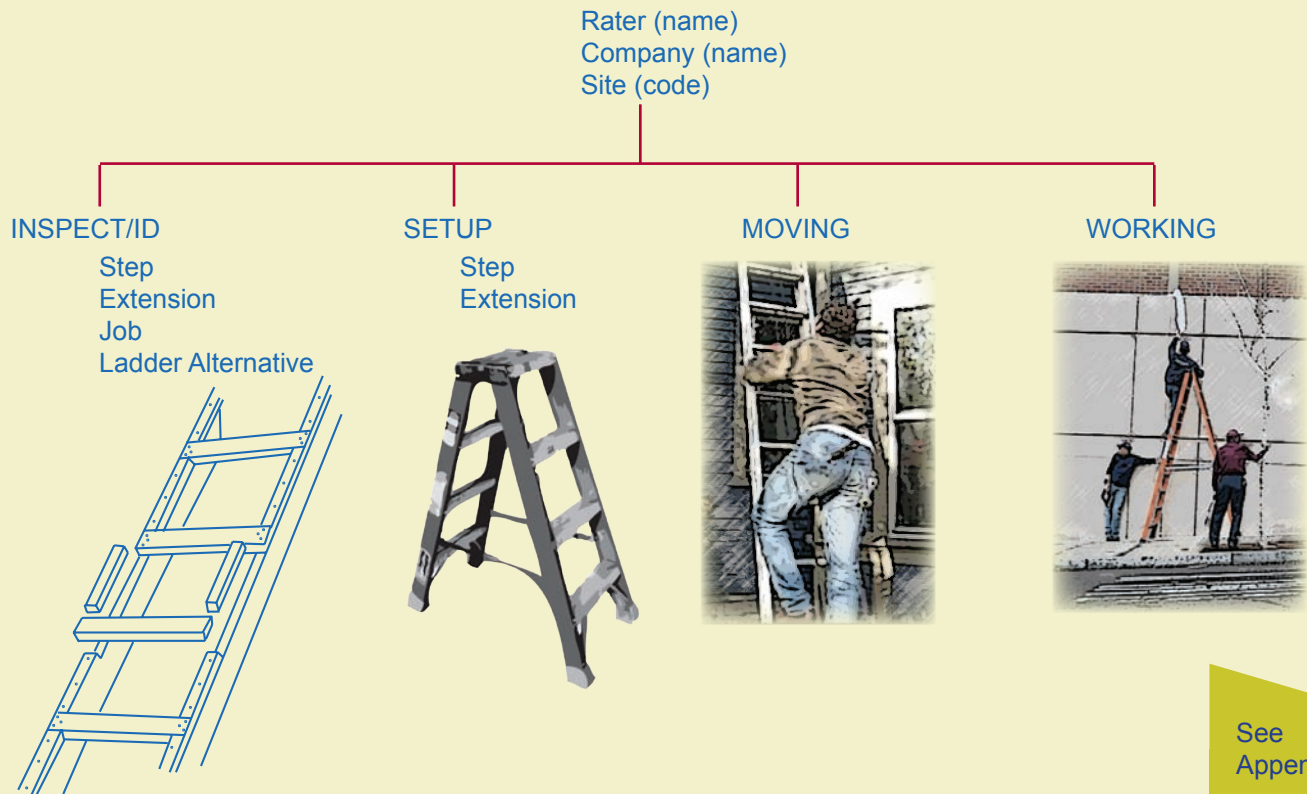

Four categories were scored: Inspect/ID, Setup, Moving, and Working. Each category has its own checklist criteria shown in Appendix 4.

### Emergency Room Study and Results

A study of the risk factors that can trigger falls from ladders was conducted in collaboration with the Liberty Mutual Research Institute for Safety, the Harvard School of Public Health, the U.S. Consumer Product Safety Commission, the National Institute for Occupational Safety and Health (NIOSH), and CPWR – The Center for Construction Research and Training.

We recruited 306 workers who had experienced an injury as the result of a ladder fall and had been treated at one of 65 hospital emergency departments sampled by the National Electronic Injury Surveillance System (NEISS).<sup>\*</sup> Of these injured workers, 86% were male, and the average age was 39. With respect to race/ethnicity, 72% were Caucasian, 11% were Hispanic, and 9% were Black. The majority (85%) of the workers had a high school, technical school, or higher level of education. The most common occupations were construction (40%) and installation, maintenance, and

<sup>\*</sup> NEISS is run by the U.S. Consumer Products Safety Commission and uses a stratified random sample of all emergency department visits in the United States. Participants in this study were individuals who had been injured at work and visited one of the 65 emergency departments in the occupational NEISS sample.





repair (21%). While 50% of the workers had fewer than 3 years of job experience, 31% had greater than 10 years. Among the injuries, 51% occurred when using step or trestle ladders, 40% while using extension or straight ladders, and 9% while using other ladder types, such as those with wheels or that can roll.

The average fall height among the injured workers was 7.5 feet; only 5% of cases fell from heights greater than 20 feet. When categorized, 36% of falls were  $\leq 4$  feet, 35% from 5-9 feet, and 29% from heights of 10 feet or greater. The greatest proportion of falls from the highest levels occurred when using extension or straight ladders (57%). The figures on this page and the next describe the body parts injured, the diagnosis, and the mechanism of ladder fall. These results were discussed in detail with the participants to provide a clear picture of the health consequences of ladder falls directly reported by people who have been injured.

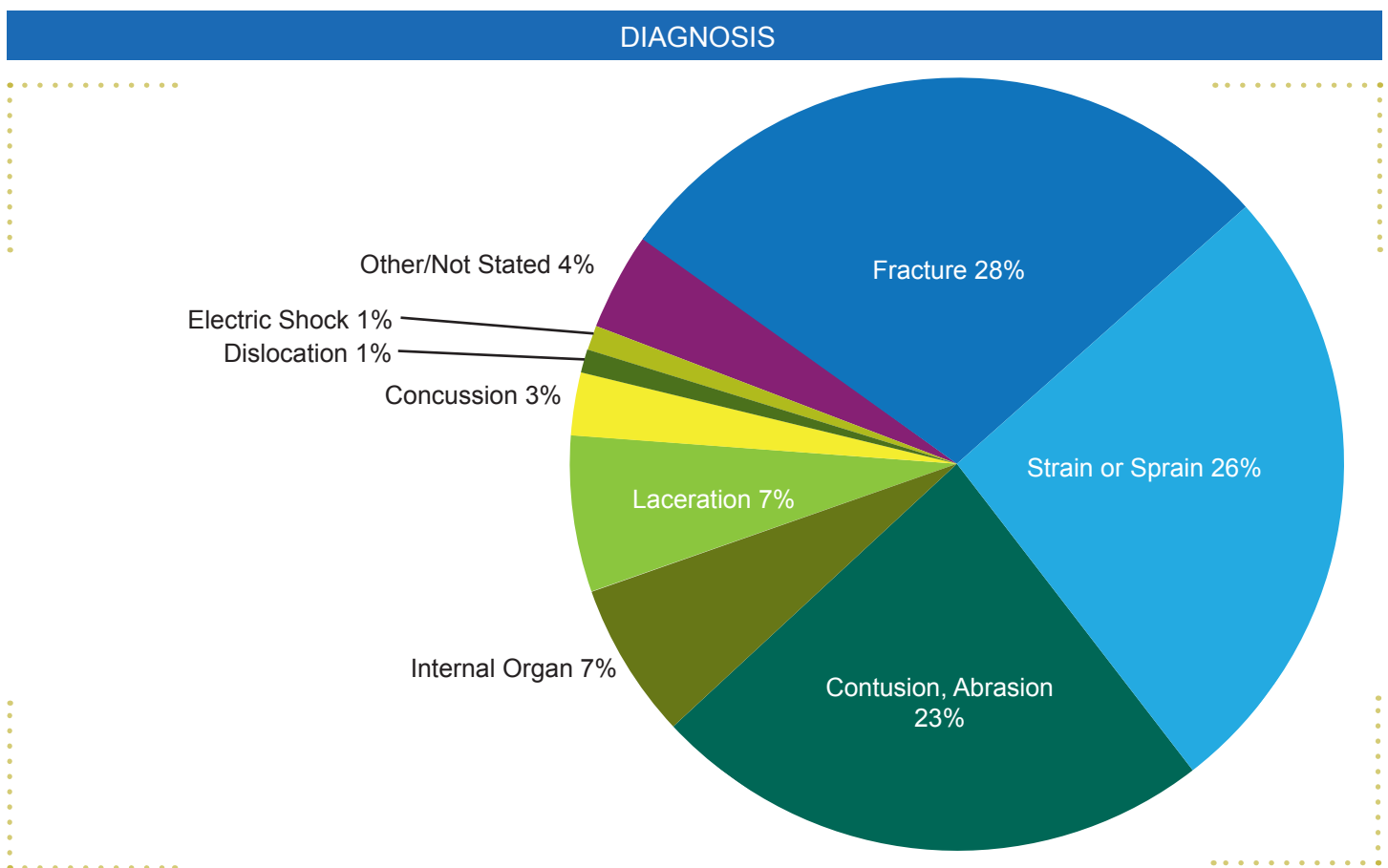
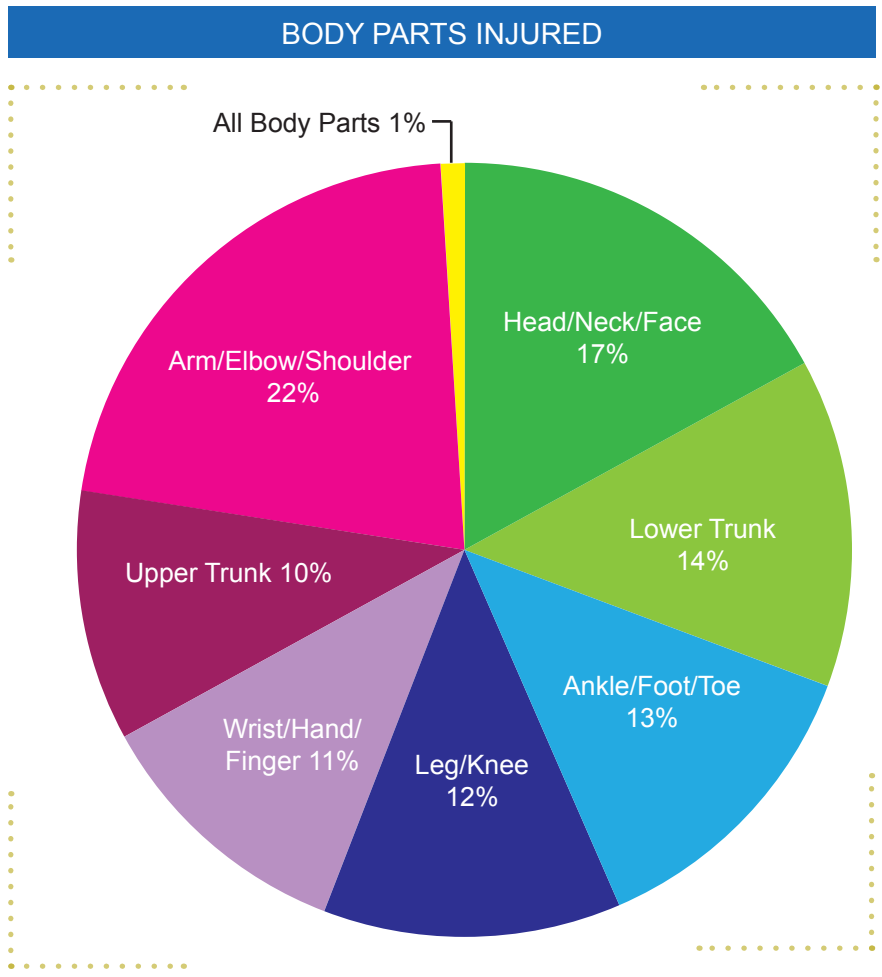

## MECHANISM OF LADDER FALL

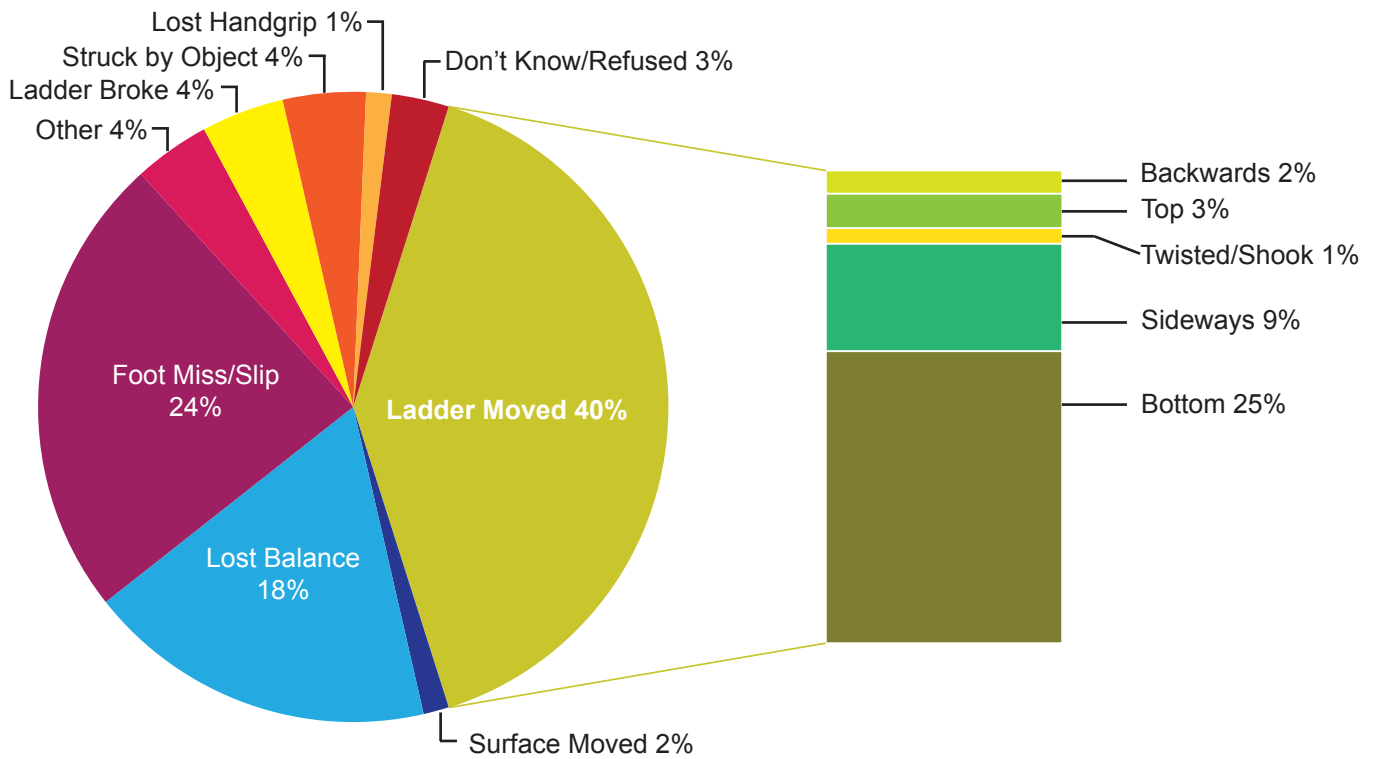

### Discussion of Site Visits and Results

The discussion of the figures was guided by the superintendents' interest and the hazards that were seen in highest numbers. Emergency room data were presented to support what we had observed on the worksites. It is important to emphasize how prevalent the riskiest hazards are, based both on the worksite observations and from reports by injured workers.

## II. Personal Susceptibility

### LEARNING OBJECTIVES

The purpose of this education module is to help construction company supervisors, foremen, and other managerial level personnel see that:

- Ladder safety is a key issue in the construction industry
- Keeping workers uninjured is cost effective
- Injured workers suffer more than just the pain of injury

In this section, we discussed how susceptible the superintendents' worksites are to ladder injuries. Superintendents were asked how many deaths they think occur annually in the US over all occupational industries. What percentage of them result from falls? How many deaths occur in construction? We then presented a PowerPoint slide showing the answers (see Injury Statistics box below).

### Bureau of Labor Statistics (BLS) Data on Injuries and Fatalities in General Industry and Construction

#### INJURY STATISTICS

##### GENERAL INDUSTRY

- 5,488 fatalities
- 835 falls (15%)
  - 132 from ladders
  - 88 from scaffold, staging

##### CONSTRUCTION

- 38% due to falls
- 24% of 36,360 nonfatal falls were from ladders

##### FATAL

- 1,178 fatalities in 2007
  - decline of 5% from 2006
- Remains highest in private sector
- Construction of buildings (a sub-sector) rose 11%

##### NONFATAL

- Recordable injury and illness incidence decreased in 2007
- Total recordable cases
  - 5.4 per 100 equivalent full-time workers
  - General industry = 4.2 cases / 100 workers
  - 4 million injuries and illnesses

The *Don't Fall For It* video (CPWR, 2006) provided a good transition from ladder falls statistics to real-life experiences and tragedies. After showing the video, we concluded with a brief discussion to make sure the superintendents had viewed and understood the material in the context we intended. Not only should they focus on the plight of the injured workers, but they must also understand that their own workers can be injured and, most important, there are ways the injuries can be reduced or prevented.



**Don't FALL For It!**

**Includes English and Spanish  
Narration and Fact Sheets**

Please visit [www.cpwr.com/rp-videosdvs.html](http://www.cpwr.com/rp-videosdvs.html) for more information on the video.

## Economic Consequences of Injuries for Workers

The next section was devoted to individual stories. The superintendents were given a chance to talk about their own experiences of falls on their worksites. It was hoped that these stories would provide a greater appreciation among the group on the seriousness of ladder falls and the need for mitigation on their part.

After discussing fall scenarios, it is useful to discuss the consequences of falls. Dr. Les Boden of Boston University has some interesting information on workers' earning capacity after returning to work post-injury (Boden and Galizzi, 2003).

### Income Loss Due to Injury

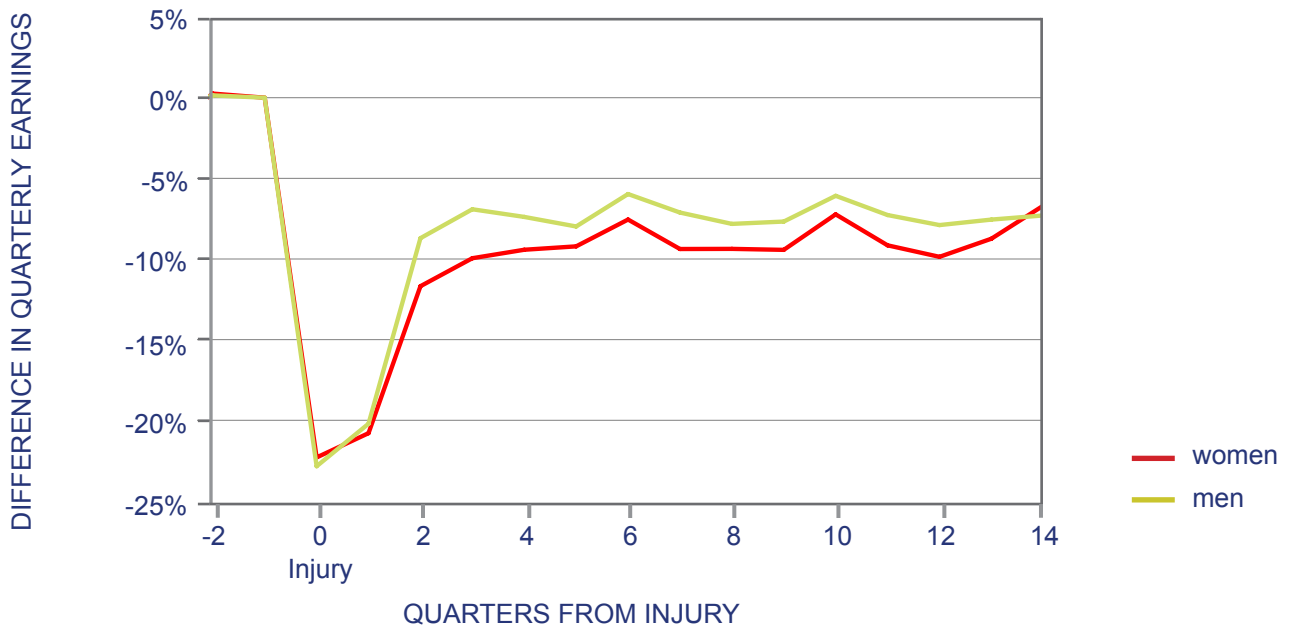

This graph represents lost wages following work injuries. The Y-axis is the difference in quarterly earnings of a worker. The X-axis is the number of quarters from injury. This work on injuries, workers' compensation, and workers' salaries shows that after an injury ( $x=0$ ) workers do not get back to the pay they would have been receiving if they were not injured. This assumption is based on the injured workers' peers. So, after injury ( $x=0$ ), workers lose about 22% of their earnings in the first 3 months. Once they are back at work, the income begins to rise. But even after 14 quarters (3.5 years) earning levels never return to their original levels. These losses are illustrated in the table below. It is important to note that it takes women considerably longer than men to regain their earnings. Even though it varies, the difference between the two lines (i.e., earnings) is around 3%.

TIME	PERCENT CHANGE	AVERAGE MALE SALARY (was \$50,000 before injury)
<b>Injury</b>	<b>-22.9%</b>	<b>\$38,550</b>
3 months post	-20.2%	\$39,900
6 months post	-8.7%	\$45,650
1 year	-7.4%	\$46,300
3.5 years	-7.3%	\$46,350

Workers lost earnings after being injured at work. Even after 3.5 years they were unable to attain the earnings level they had before being injured.

## Economic Consequences of Injuries for the Construction Industry

Finally, more to the immediate impact on the superintendents and their companies, costs should be discussed. Workers' compensation, liability insurance, and so forth are important metrics. Injury costs should be stressed as they may present the most convincing need to create change at worksites. We currently do not have much data on this, but maybe discussing the topic with the superintendents will tease out how important these costs are. This is especially true if any of the companies are self-insured. Who pays? The construction manager or the subcontractor?

Of the \$1.36 billion spent annually on construction injuries in the US, 46% is paid for by worker's compensation (Dong et al., 2007).

The total costs of fatal and nonfatal injuries in the construction industry were estimated at \$11.5 billion in 2002, 15% of the costs for all private industry. The average cost per case of a fatal or nonfatal injury is \$27,000 in construction, almost double the per-case cost of \$15,000 for all industry in 2002 (Wachrer et al., 2007).



Unsafe posture. Should not be on top step or over the step ladder. A taller ladder is needed to allow for safer access to the interstitial area.

Photo credit: CPWR/elcoshimages.org



### III. Peer Norms

#### LEARNING OBJECTIVES

The purpose of this module is to show superintendents how the work environment and psychosocial aspects of the workplace (i.e., safety culture) can affect safety and, specifically, ladder use. They should understand how they can influence the workplace in both positive and negative ways.

From a construction engineering perspective, creativity is paramount, but re-inventing the wheel is not. There is minimal variation among construction management companies and worksites in how work is organized and managed. Even though most companies find a niche within the sector, few stray from standard industry practices. It is therefore important, through a guided discussion, to show superintendents what their colleagues are doing and to assess what they think of their colleagues' views. It is also possible to discover that what an individual believes to be a norm is actually not.

The following questions were used to generate a discussion around safety-culture norms in the construction industry:

- What do you think is the industry standard for safety? Why?
- What change is needed?
- What are the alternatives to ladder safety?

Fall prevention for climbing the ladder. Should be properly secured at the top and bottom. Platform for reaching top of ladder should be ample for standing and moving securely.

Photo credit: NIOSH/Matt Gillen/elcoshimages.org

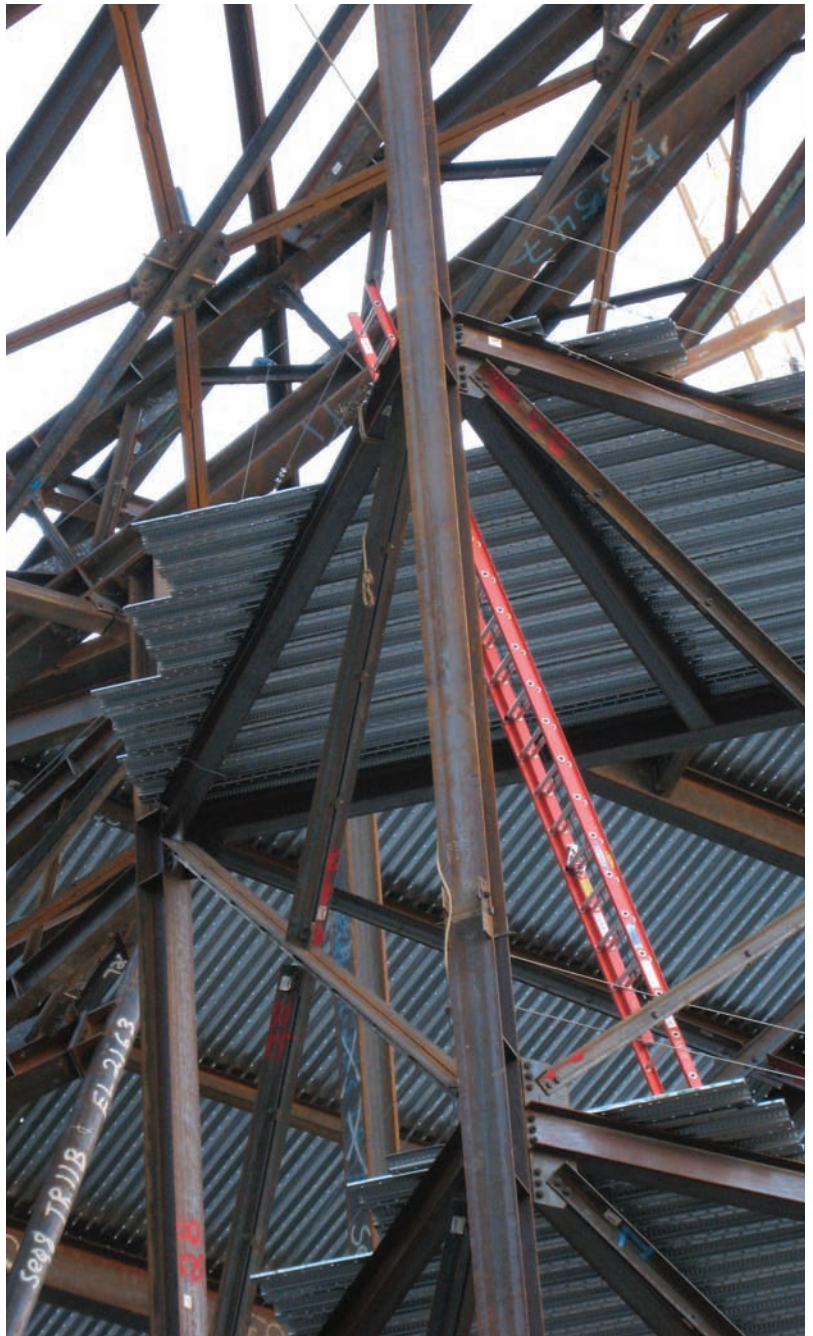



## IV. Skills Training

### LEARNING OBJECTIVES

Understand how external factors affect how work is performed and whether it is performed safely. These factors include:

- Training
- Deadlines
- Communication skills

Following the discussion of peer norms and safety culture, this section focuses on skills necessary to reduce the risks of ladder falls.

### Training

Superintendents were advised that it is in their best interest to ensure that each employee using ladders:

- Can recognize hazards related to ladders
- Knows the correct procedures for erecting, maintaining, and disassembling the fall-protection systems being used
- Knows the proper construction, use, placement, and care in handling of ladders
- Knows the maximum intended load-carrying capacities of ladders
- Can be retrained as necessary so that he or she maintains the understanding and knowledge acquired through compliance with this section

#### CASE VIGNETTE FOR PRACTICING COMMUNICATION SKILLS

**GREENCOM**  
construction

##### NEW CONSTRUCTION

Behind schedule and over budget.

Injuries have plagued the worksite.

A foreman is on the top step of a 14' step ladder screwing in a light bulb 20' above the ground.

The foreman is in charge of a key group of workers and is vital for the completion of the project.

The foreman is a hothead and has consistently given you problems; however, he does good work, and his journeymen and apprentices are loyal to him.

All his workers are overworked and stressed. They are busy doing their work, so he is forced to use leftover supplies (i.e. the ladder) to do this simple task unsafely.

### Communication Skills

To tap into what skills and frames of mind are best for promoting safe ladder practices, a case vignette was presented. The intent was to outline several key aspects of worksite interactions.

#### For the group

This exercise makes use of role playing to analyze a typical job situation that can lead to hazardous work behaviors. It provides an opportunity to practice communication skills. The setting is a fictitious company called Greencom Construction.

One participant will play the part of the foreman who just wants to be left alone so he can get his work done. The other participant will be the site superintendent on the walk-through.

They are to act out their parts assuming the superintendent confronts the foreman.

Some potential considerations:

- Everyone is stressed and hurried.
- The foreman is needed on site to work and manage his crew.
- There are no on-site safety personnel.

See  
Appendix

5

## COMMUNICATION SKILLS

### 3 TYPES OF COMMUNICATION

Explain that assertiveness is optimal.

1. Passive
2. Aggressive
3. Assertive

Discuss poor forms of communication.

### I PLAN

- I : I statements
- P: Plan ahead
- L: Listen to tone of voice
- A: Pay attention (be aware of body language)
- N: Know what you want and know what you want to say



The facilitators provided examples of and discussed differences among assertive, aggressive, and non-assertive (passive) communication styles (including non-verbal behavior):

1. “Think about how you want to talk to your workers.”

a. Passive. . . hesitant, uninterested

Example: “Do you think it would be okay if...?”

Disadvantages: You may not be understood; worker may think that you do not mean what you say or that you don’t care.

b. Aggressive. . . angry or rude

Example: “I don’t care what you want. Do it my way!” Aggressive includes raising of voice, tone of voice, as well as aggressive body language and movements.

Disadvantages: You may not be understood; worker may become angry or defensive.

c. Assertive

Example: “I have learned it works better if I always use three points of contact on the ladder. It will be safer for both of us if you do this too.”

Advantages: It provides your best chance of being understood; the worker will know what you want, and you will know that you have given a clear direction using yourself as a model.

## Illustrations of Ladder Use

As a way of concluding the session, the group can scan through several pictures of poor ladder techniques pointing out what they think is wrong (i.e., correctable actions).



Ladder is placed incorrectly. Ladder should be extended out with its spreaders locked. If the work area is too small, an alternative should be used.

Photo courtesy of the Harvard Construction Group



Unsafe posture. Worker should be facing the ladder and on a lower rung. A taller ladder facing the opposite direction may be necessary.

Photo courtesy of the Harvard Construction Group





Unsafe posture. Worker should be on a lower rung; a taller ladder is needed.

Photo courtesy of the Harvard Construction Group



Extension ladder should extend past the roof by at least three feet. Worker is in an unsafe posture. He should be standing on a rung and should be wearing fall protection.

Photo courtesy of Jack T. Dennerlein



Adjusts for 14' to 17' landings



The portable stairs on the right are able to be reused on several projects while allowing the workers a safer angle for ascent and descent compared to the gang-ladder on the left.

Photos courtesy of TJ Lyons, Turner Construction Company



The lift on the right allows a worker to reach heights while providing a safe working platform and small footprint in the hallway compared to the very tall stepladders on the left that are still not tall enough for the workers to safely reach their job tasks.

Photos courtesy of TJ Lyons, Turner Construction Company





# Appendices

## Appendix 1: Proper Ladder Setup Dimensions

Place an extension ladder at a  $75\frac{1}{2}^\circ$  angle.

The set-back ("S") needs to be 1 foot for each 4 feet of length ("L") to the upper support point.

Ladder length to support point "L"	Setback between support point & ladder base "S"
12'	3'
16'	4'
20'	5'
24'	6'
28'	7'
32'	8'

For a quick estimate, count the rungs. They are spaced 12" apart.

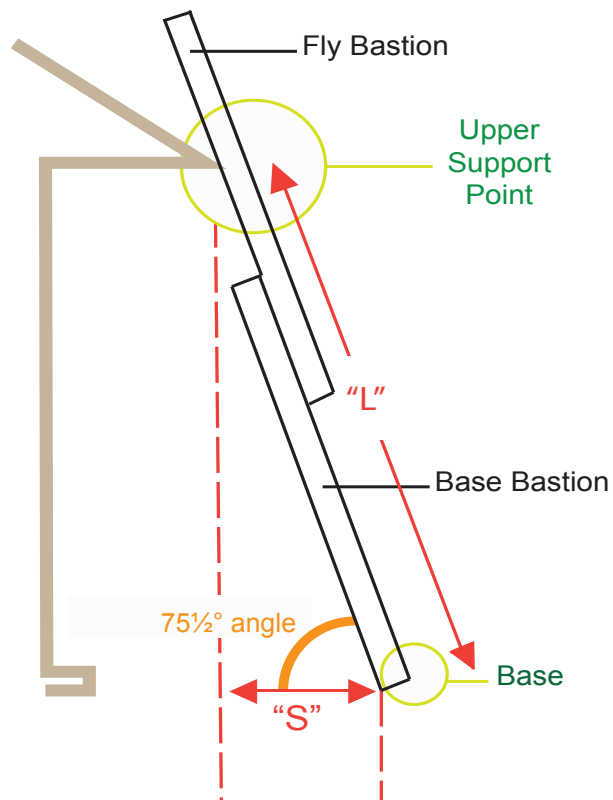

$$"S" = \frac{1}{4} "L"$$

## Appendix 2: Ladder Safety Knowledge Questions

Please answer the following questions with the single best answer.

1. A 250-pound man using a 15-pound sledge hammer at height should use what type of ladder?
  - a. Type 3
  - b. Type 2
  - c. Type 1A
  - d. Type 1
2. What is the annual cost in dollars of work-related injuries in the US?
  - a. Less than a million
  - b. Greater than a million, but less than 100 million
  - c. Greater than 100 million, but less than a billion
  - d. Greater than a billion
3. A step/trestle ladder provides adequate protection against high lateral (side-to-side) force.
  - a. True
  - b. False
4. What is the best way to find out what type of ladder can handle the weight load necessary to complete a job task?
  - a. Trial and error
  - b. Ask co-workers
  - c. Read the label on the ladder
  - d. Ladders are built to handle the needs of the construction industry
5. What can best keep a ladder from slipping when on a wet surface?
  - a. Putting a box in front of its steps
  - b. Having its treads in good condition
  - c. Climbing on the ladder and shaking it to see if it moves easily
  - d. Having a co-worker sit on the bottom steps of the ladder
6. A worker on a ladder along a 45-inch-high parapet should be most concerned about which of the following?
  - a. How high above the roof he or she is
  - b. Having a co-worker hold the ladder as extra support
  - c. How high above the ground he or she is
  - d. Rain
7. Once workers return to work after being injured, usually they will:
  - a. Eventually achieve the same pay grade that they would have attained had the injury and absence not occurred
  - b. Earn more
  - c. Never achieve the same pay grade that they would have attained had the injury and absence not occurred
  - d. Quit

8. A rushed worker is most likely to:
- a. Get work completed faster
  - b. Focus on safe work practices
  - c. Do better quality work
  - d. Fall
9. What is the most practical yet safe method of bringing a hammer up a ladder?
- a. Carrying it in your hand
  - b. Hoisting it up with a bucket and rope pulley
  - c. Placing it in a tool belt
  - d. Hammers are not safe to use on ladders
10. How many points of contact with a ladder should a worker minimally maintain?
- a. 1
  - b. 2
  - c. 3
  - d. 4

### Extension Ladder Safety: Setup and Repositioning

#### A. Select the Ladder

1. Match ladder duty rating (250, 300, or 375 lbs) to job
2. Choose proper length of ladder for job  
(Single section ladder max. length: 30 feet)  
(2 section ladder max. length: 48 feet)  
(3+ section ladder max. length: 60 feet)
3. Choose ladder type (conductive/ nonconductive)
4. Inspect ladder for damage and proper operation

#### B. Scan the Worksite

1. Check for electrical hazards (e.g., overhead power lines)
2. Check for other overhead obstructions
3. Note clutter and traffic patterns in immediate work area
4. Locate level and firm surface for base of ladder
5. Note environmental conditions (wind, rain, snow/ice)

#### C. On-site Ladder Inspection

1. Check that rungs/cleats, safety feet, etc. are secure
2. Check rungs/cleats for mud, paint, oil, or other slick/sticky substances
3. Check for places on ladder that could cause cuts or punctures (loose screws, bolts, hinges, etc.)
4. Check for damaged ropes and pulleys
5. Check that hooks and locks form a secure grip

#### D. Ladder Extension/Setup

1. Use two people to erect ladder
2. Place bottom of ladder at base of structure
3. Walk ladder up hand-over-hand
4. Extend ladder 3 feet above resting point on roof or rest against wall
5. Verify minimum overlap of ladder sections and that locks are properly engaged:  
(Up to 36', min overlap: 3 feet per section)  
(Over 36', up to 48', min. overlap: 4' per section)  
(Over 48', up to 60', min. overlap: 5' per section)
6. Pull base away from foundation for proper angle (1/4 rule: 1 foot away from base for every 4 feet of ladder length to upper support)
7. Clear clutter, level the bottom, and make sure footing is stable
8. Ensure that top of ladder is both flat and firm
9. Secure ladder at bottom by appropriate means
10. Set up traffic barrier

#### E. Ladder Testing/Securing

1. Re-check setup before or during first climb (levelness, stability of base, rungs/cleats, etc.)
2. Re-check cleats for mud, paint, oil, or other slick/sticky substances
3. Use someone to keep ladder base from slipping
4. Check for stability while climbing first couple of rungs

## Extension Ladder Safety: Use

### A. General Ladder Use

1. Re-check setup during climb (levelness, stability of base, etc.)
2. Re-check cleats for mud, paint, oil, or other slick/ sticky substances
3. Use a spotter whenever possible
4. Maintain a 3-point contact with ladder
5. Face ladder when climbing, descending, or working
6. Keep body centered within frame of ladder
7. Re-check ground for clutter and note traffic patterns
8. Avoid standing on top three rungs
9. Use a rope or lift to raise or lower materials or tools
10. For access to upper level, re-check top tie-off
11. For access to upper level, re-check that ladder extends 3 feet above resting point

### B. Climbing Ladder While Carrying Materials by Hand (when a rope or lift is not practical)

1. Rope-off area on ground underneath work area
2. Keep at least one hand on ladder
3. Put both feet on each rung while climbing
4. Keep body centered within frame of ladder
5. Carefully transfer carried items to secure location when working height is reached

### C. Working from a Ladder

1. Keep both feet on same rung while working
2. Keep belt buckle inside frame of ladder
3. Re-check area below in case load is dropped
4. Tie-off top of ladder
5. Use body harness and separately-anchored lifeline
6. Maintain a 3-point contact with ladder

### D. Stepping On or Off a Ladder at Height

1. Free hands of all materials before stepping on or off
2. Maintain 3-point contact
3. Re-check tie-off at top of ladder
4. Check for hazards before stepping on or off

### E. Descending Ladder

1. Maintain 3-point contact with ladder
2. Face ladder while walking down
3. Put both feet on each rung while descending
4. Check ground for clutter before stepping off

Source: Lineberry GT, Wiehagen B, Scharf T, McCann M. Progress toward a multi-use educational intervention for reducing injury risk in the set-up and use of extension ladders. Proceedings. 6th International Conference, Scientific Committee on Education and Training in Occupational Safety and Health, International Commission on Occupational Health. Baltimore, MD, October 27-30, 2002.

## Appendix 4: Combined Results of All Sites of Companies Visited

Please see KEY on p. 35 for an explanation of categories.

### Ladder Alternative Types (n=302)

Equipment	Percent (n)
Portable Scaffold	55.0% (166)
Scissor Lift	22.5% (68)
Aerial Bucket	2.3% (37)
Scaffolding	8.6% (26)
Ladder Jack	0.3% (1)
Unknown	1.3% (4)

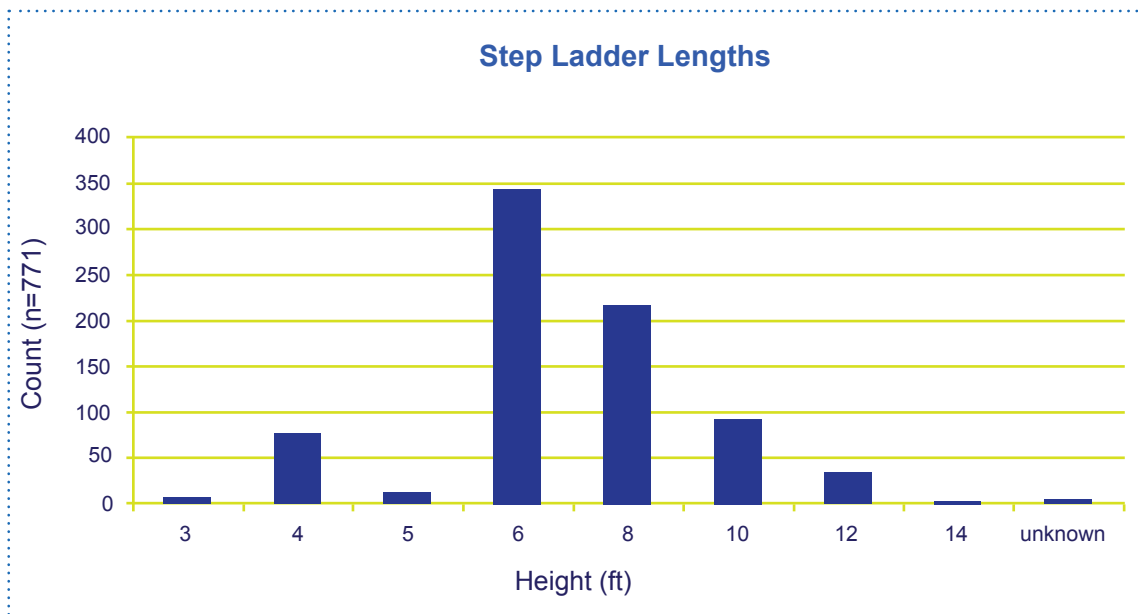
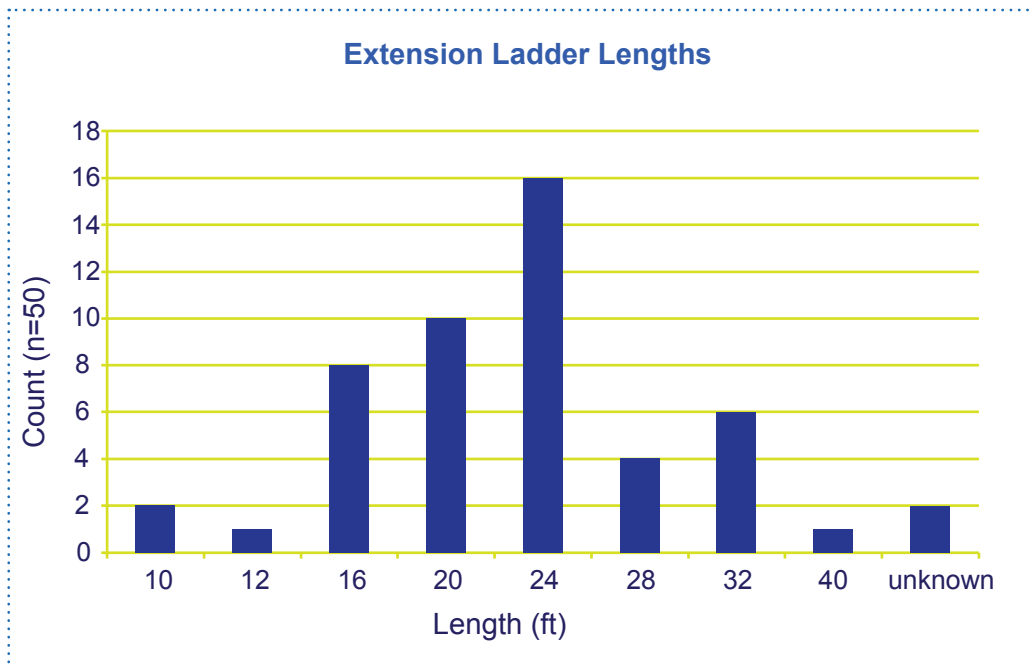



## Step Ladder Condition

Prevalence of hazards (% , n) related to the quality of step ladders (n=771).  
“Yes” denotes compliance with the best practice. “No” relates to divergence.

<b>Best Practice</b>	<b>Yes (n)</b>	<b>No (n)</b>	<b>Unknown (n)</b>
Rated Type I	96.4% (744)	1.0% (8)	2.6% (20)
Free of defects	95.6% (738)	3.6% (28)	0.8% (6)
Has labels	84.3% (651)	14.7% (113)	1.0% (8)

## Step Ladder Setup

Prevalence of scores (% , n) of step ladder (n=401) setups in various categories.

<b>Best Practice</b>	<b>Yes (n)</b>	<b>No (n)</b>	<b>Unknown (n)</b>
Clear of electrical hazards	98.8% (396)	0.7% (3)	0.5% (2)
Clean and dry	95.5% (383)	3.5% (14)	1.0% (4)
Spreaders are locked	94.0% (377)	5.3% (21)	0.7% (3)
On a flat/stable surface	91.0% (365)	9.0% (36)	0.0% (0)
Bottom clear of tripping hazards	87.0% (349)	12.5% (50)	0.5% (2)

## Climbing a Step Ladder

Prevalence of scores (% , n) of movements on step ladders (n=140) in various categories.

<b>Best Practice</b>	<b>Yes (n)</b>	<b>No (n)</b>	<b>Unknown (n)</b>
One person on the ladder	99.3% (139)	0.7% (1)	0.0% (0)
Gets on/off the bottom of the ladder only	96.4% (135)	3.6% (5)	0.0% (0)
Stays off the top two steps	94.3% (132)	5.7% (8)	0.0% (0)
Keeps center of mass within ladder’s support	94.3% (132)	5.7% (8)	0.0% (0)
Moves slowly	87.1% (122)	12.9% (18)	0.0% (0)
Faces the ladder	86.4% (121)	13.6% (19)	0.0% (0)
Checks stability of setup and ladder before climbing	80.0% (112)	12.1% (17)	7.9% (11)
Maintains three points of contact	72.2% (101)	27.1% (38)	0.7% (1)
Hands are free of objects while climbing	46.4% (65)	51.4% (72)	2.2% (3)

## Working on a Step Ladder

Prevalence of scores (% , n) of working on step ladders (n=160) in various categories.

<b>Best Practice</b>	<b>Yes (n)</b>	<b>No (n)</b>	<b>Unknown (n)</b>
One person on the ladder	99.4% (159)	0.6% (1)	0.0% (0)
Holds only one tool	97.5% (156)	1.9% (3)	0.6% (1)
Stays off the top two steps	91.3% (146)	8.8% (14)	0.0% (0)
Ladder is the proper length for the task	88.1% (141)	11.9% (19)	0.0% (0)
Uses minimum forces	71.9% (115)	22.5% (36)	5.6% (9)

## Working on a Step Ladder (cont'd)

Prevalence of scores (% , n) of working on step ladders (n=160) in various categories.

<b>Best Practice</b>	<b>Yes (n)</b>	<b>No (n)</b>	<b>Unknown (n)</b>
Faces the ladder	69.4% (111)	30.6% (49)	0.0% (0)
Keeps center of mass within ladder's support	86.3% (138)	13.8% (22)	0.0% (0)

## Extension Ladder Condition

Prevalence of hazards (% , n) related to the quality of extension ladders (n=50).

“Yes” denotes compliance with the best practice. “No” relates to divergence.

<b>Best Practice</b>	<b>Yes (n)</b>	<b>No (n)</b>	<b>Unknown (n)</b>
Free of defects	96.0% (48)	4.0% (2)	0.0% (0)
Rated Type I	94.0% (47)	0.0% (0)	6.0% (3)
Has labels	80.0% (40)	14.0% (7)	6.0% (3)

## Extension Ladder Setups

Prevalence of scores (% , n) of extension ladder (n=23) setups in various categories.

<b>Best Practice</b>	<b>Yes (n)</b>	<b>No (n)</b>	<b>Unknown (n)</b>
Clear of electrical hazards	95.6% (22)	0.0% (0)	4.4% (1)
Bottom clear of tripping hazards	91.3% (21)	8.7% (2)	0.0% (0)
Clean and dry	87.0% (20)	13.0% (3)	0.0% (0)
At a proper angle	78.3% (18)	21.7% (5)	0.0% (0)
Rails extend 3' above platform	65.2% (15)	30.4% (7)	4.4% (1)
Top of ladder secured	30.4% (7)	65.2% (15)	4.4% (1)
Bottom of ladder secured	26.1% (6)	73.9% (17)	0.0% (0)

## Job-Made Ladder Condition

Prevalence of hazards (% , n) related to the quality of job made ladders (n=28).

“Yes” denotes compliance with the best practice. “No” relates to divergence.

<b>Best Practice</b>	<b>Yes (n)</b>	<b>No (n)</b>	<b>Unknown (n)</b>
Cleats made of 1x4 planks	100% (28)	0.0% (0)	0.0% (0)
Has filler blocks	100% (28)	0.0% (0)	0.0% (0)
Free of defects	96.4% (27)	3.6% (1)	0.0% (0)
Rails made of 2x6 planks	92.9% (26)	7.1% (2)	0.0% (0)
Rails extend 3' past platform	85.7% (24)	3.6% (1)	10.7% (3)
Wood is seasoned	3.6% (1)	0.0% (0)	96.4% (27)

## KEY

### Step Ladder Condition

- 1** **Is it free of defects and does it have all its parts?** There should be no cracks in any of the steps or supports, no bent or dented beams/rails, and no sharp spurs that can catch clothing or cause a laceration. If it is a step ladder, does it have its locking stays and are the steps, rails, and other structural components in good condition?
- 2** **Is it Type I?** Ladders are graded by types based on their weight capacity. There are several types. All Type I ladders are for industrial use; there are Type I (250 lbs), IA (300 lbs), and IAA (375 lbs.) Types IA and IAA are considered Type I for this question. Types II and III are household ladders.
- 3** **Does it have labels?** Does the ladder have its type designation and warning labels or have they been scraped off due to wear and tear?
- 4** **Is it set up for use?** Step ladders are often stored with the spreaders locked and in an A-frame. Answer "yes" only if you are sure the ladder has been or will be used. If you are unsure, answer "unknown." If it is clear the ladder is being stored, answer "no." If your answer is "yes," please complete the "Step Ladder Setup" form described below.

### Step Ladder Setup

- 1** **Flat/stable surface:** Is the step ladder on a flat, stable, and hard surface? Are all four feet touching the ground so that it doesn't rock between two tripods? Is the surface hard enough to prevent it from creeping and settling once it is loaded? Step ladders need to be on flat surfaces and should not be set up on other elevated platforms, such as scaffolding, ladder jacks, etc.
- 2** **Bottom clear:** Is the bottom of the ladder clear of loose materials that can provide a trip or slip hazard when stepping on/off the ladder. Is the ladder clear of any doors that can swing open and hit it?
- 3** **Spreaders locked:** Are both spreaders that create the A-frame of the ladder fully engaged and locked?
- 4** **Area marked off:** If the ladder is being used in a public area (non-construction personnel can access the area), is the work area marked off to warn passing individuals? Note: this is for non-construction sites only; leave this question unanswered if you're on a construction site with limited access.
- 5** **Clear of electrical:** Is the setup clear of any electrical hazards? Essentially, what is the risk of the ladder touching or being touched by electrical supply cables.
- 6** **Clean and dry:** Is the ladder clean of loose debris and dry? Is it free of anything that could increase the risk of slipping on the rungs? A ladder may have a lot of dried paint or markings on it.
- 7** **In use:** Is the ladder in use? If "yes," please complete either "Moving on a Ladder" or "Working from a Ladder" below.

### Moving on a Ladder

- 1** **Face ladder:** Does the worker (for this example, we'll say it's a man) face the ladder when moving up and down it (that is, toes pointing inward and hands towards the rails)?
- 2** **Off top steps:** Does he stay off the top steps of the ladder? For an extension ladder, this includes the top three rungs of the ladder; for a step ladder, it should be the top two steps (the top cap and the first step down from there).
- 3** **3-pt contact:** For the most part, does he have either two feet and one hand or two hands and one foot on the ladder when moving?
- 4** **One person:** Is only one person on the ladder at a time?
- 5** **Belt buckle:** Does the person's belt buckle remain between the two rails of the ladder (that is, does he stay centered when moving on the ladder). Does he keep his center of gravity (as indicated by belt buckle or belly button) over the steps within the two rails of the ladder?

- 6 **Moves slowly:** Does the worker move slowly and deliberately rather than rush up and down the ladder? Is it apparent that he is paying attention to how he is moving and to the various aspects of his contact with the ladder?
- 7 **Hands free:** Are the worker's hands free of any tools or materials? Is he using a tool belt for a small number of tools and other means to transport a greater number of tools and materials?
- 8 **On/off bottom/top:** Is he getting on and off a step ladder only at the bottom and getting off an extension ladder only at the bottom or top?
- 9 **Checks stability:** Before climbing, does the worker check the stability of the ladder? This requires some judgment: sometimes if a ladder is well secured, the user simply looks at it and determines its stability through visual inspection; however, if a step ladder is moved and has just been setup, he may want to check the stability by a simple jiggle. If you don't know, leave this one as "unknown."

### Working from a Ladder

- 1 **Proper length:** Is the length and location of the ladder such that the worker does not have to complete the task with an extended reach over his head?
- 2 **Face ladder:** Does the individual face the ladder when moving up and down it (that is, toes pointing inward and hands towards the rails)?
- 3 **Off top steps:** Does he stay off the top steps of the ladder? For an extension ladder, this includes the top three rungs of the ladder; for a step ladder, it should be the top two steps (the top cap and the first step down from there).
- 4 **One person:** Is there only one person on the ladder at a time?
- 5 **Belt buckle:** Does the user keep his center of gravity (as indicated by belt buckle or belly button) over the steps within the two rails of the ladder? He does not overreach; if he needs to reach an extended area, he gets down and moves the ladder.
- 6 **One tool:** Does the worker handle only one tool at a time when completing tasks. Does he store unused tools in a tool belt or on a shelf on the ladder instead of holding multiple tools?
- 7 **Minimum forces:** Does the worker minimize forces to complete the task? If forces are high, does he complete the task in a stable manner?
- 8 **Worker tied off:** If he is working above 6 feet or near a sharp drop-off, is he tied off? Note, this is required only when he is working with his feet more than 6 feet above the surface; therefore, if the ladder is 8 feet or shorter, he doesn't need to be tied off. However, if he is working on a open floor near the edge, he must be tied off whenever he steps up on the ladder to work.



Greencom Construction Company is working on the new construction of a major medical research building in Boston. The site is behind schedule and over budget. At the same time, injuries have plagued the worksite since the start of the project. You, the superintendent, are on a daily walk-through of a floor when you notice a foreman on the top step of a 14' step ladder screwing in a light bulb 20' above the ground. The foreman is in charge of a key group of workers and is vital for the completion of the project. If the foreman is injured, the site will be further delayed. The foreman is a hothead and has consistently given you problems, but he does good work and his journeymen and apprentices are loyal to him. All his workers are overworked and stressed. They are busy doing their work, so he is forced to use leftover supplies (i.e., the ladder) to do this simple task unsafely.

Superintendents will be split into groups of two. One person will play the role of the foreman; the other will be the superintendent.

For the group:

- One participant is the foreman who just wants to be left alone so he can get his work done.
- The other participant is the site superintendent on the walk-through.
- You are to act out your part assuming the superintendent confronts the foreman.

Some potential considerations:

- Everyone is stressed and hurried.
- The foreman is needed on site to work and run his crew.
- There are no site safety personnel.

## References

---

- Bandura A. Self-efficacy mechanism in human agency. *Am Psychol* 1982; 37(2):122-147.
- Boden LI, Galizzi M. Income Losses of Women and Men Injured at Work. *J Hum Resour* 2003; 38(3):722-757.
- Brennan M, Lombardi D, Smith GS, Courtney T, Young J, Dennerlein J, Perry MJ. Falls from ladders: Preliminary results from a case-crossover study of emergency room cases. Presented at the 18th Annual Construction Safety and Health Conference and Exposition, Rosemont, IL, February 12-14, 2008.
- Bunton R, Murphy S, Bennett P. Theories of behavioural change and their use in health promotion: Some neglected areas. *Health Ed Res* 1991; 6(2):153-162.
- Bureau of Labor Statistics. Census of Fatal Occupational Injuries: 1992-2007. Washington, DC: US Department of Labor, 2009. <http://www.bls.gov/iif/oshwc/cfoi/cfch0006.pdf>.
- CPWR – The Center for Construction Research and Training. Don't Fall for It [video/13 minutes]. Silver Spring, MD: CPWR, 2006.
- CPWR – The Center for Construction Research and Training. The Construction Chart Book: The U.S. Construction Industry and its Workers. Silver Spring, MD: CPWR, 2008.
- Dong X, Ringen K, Men Y, Fujimoto A. Medical costs and sources of payment for work-related injuries among Hispanic construction workers. *J Occup Environ Med* 2007; 49(12):1367-1375.
- Edwards J, Tindale RS, Heath L, Posavac EJ (eds). *Social Influence Process and Prevention*. New York: Plenum Press, 1990.
- Rogers EM. *Diffusion of Innovations*, 5th ed. New York: Free Press, 2003.
- Wachrer GM, Dong XS, Miller T, Haile E, Men Y. Costs of occupational injuries in construction in the United States. *Accid Anal Prev* 2007; 39(6):1258-1266.
- Weinstein ND (ed). *Taking Care: Understanding and encouraging self-protective behavior*. New York: Cambridge University Press, 1987.



## **Other Information Resources**

Your Local Office of the Occupational Safety and Health Administration  
[www.osha.gov](http://www.osha.gov)

National Institute for Occupational Safety and Health  
[www.cdc.gov/niosh/homepage.html](http://www.cdc.gov/niosh/homepage.html)  
(800) 356-4674

The Electronic Library of Construction Occupational Safety and Health  
[www.elcosh.org](http://www.elcosh.org)  
Photos on pages 1, 8, 9, 19, and 20 can be found on [www.eLCOSHImages.org](http://www.eLCOSHImages.org)

CPWR – The Center for Construction Research and Training  
[www.cpwr.com](http://www.cpwr.com)

CPWR is a 501(c)(3) nonprofit research and training institution created by the Building and Construction Trades Department, AFL-CIO, and serves as the research arm of the BCTD. CPWR is uniquely situated to provide safety and health research and information to the construction industry.