

NIOSH/OSHA/USCG/EPA

Occupational Safety and Health Guidance Manual for Hazardous Waste Site Activities

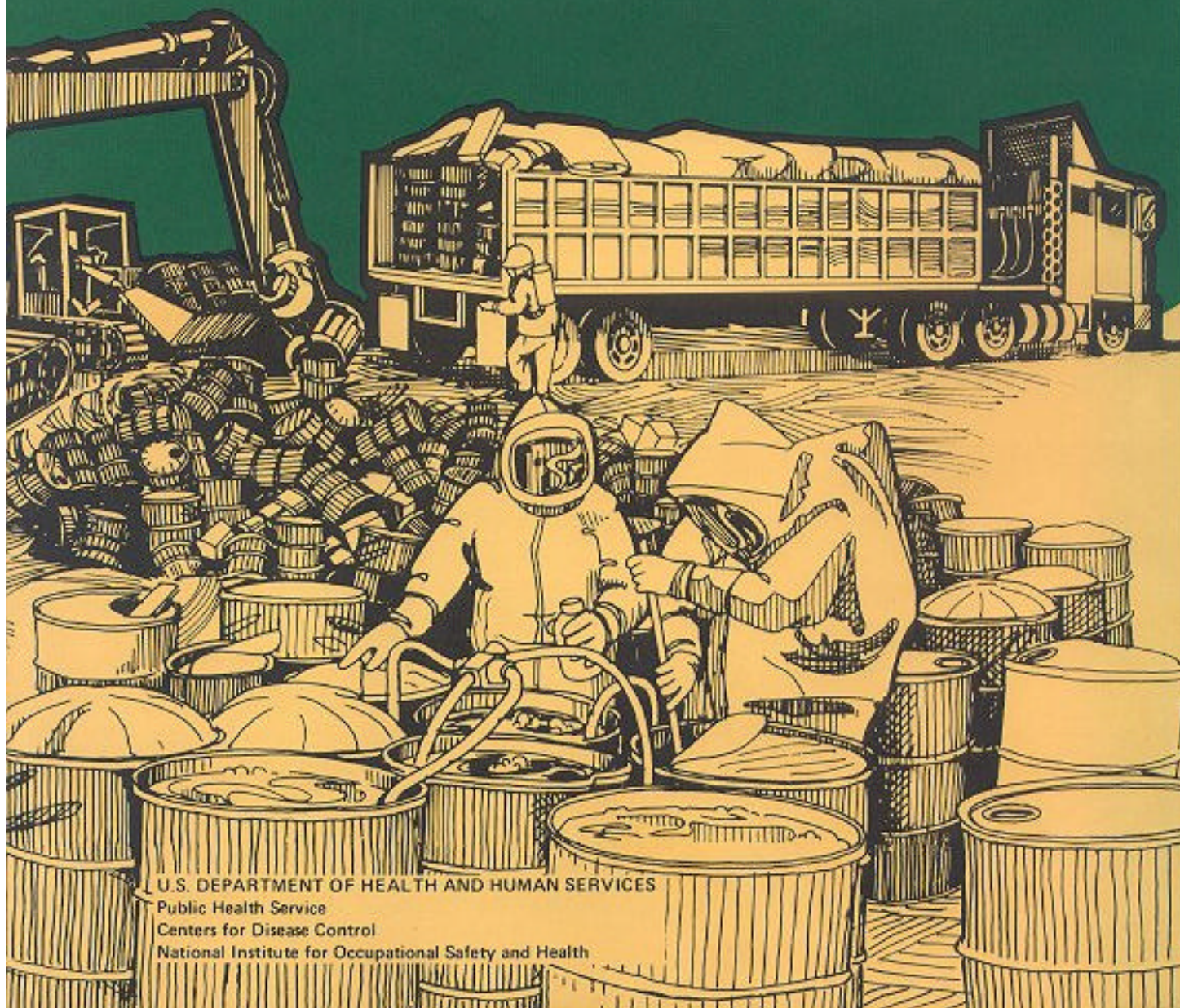

U.S. DEPARTMENT OF HEALTH AND HUMAN SERVICES
Public Health Service
Centers for Disease Control
National Institute for Occupational Safety and Health

Occupational Safety and Health Guidance Manual for Hazardous Waste Site Activities

Prepared by:

National Institute for Occupational Safety and Health (NIOSH)

Occupational Safety and Health Administration (OSHA)

U.S. Coast Guard (USCG)

U.S. Environmental Protection Agency (EPA)

U.S. Department of Health and Human Services
Public Health Service
Centers for Disease Control
National Institute for Occupational Safety and Health

October 1985

Acknowledgments

The *Occupational Safety and Health Guidance Manual for Hazardous Waste Site Activities* is a result of the collaborative efforts of individuals representing the National Institute for Occupational Safety and Health (NIOSH), the lead agency, and the Occupational Safety and Health Administration (OSHA), the U.S. Coast Guard (USCG), and the U.S. Environmental Protection Agency (EPA). Agency representatives on the steering committee for this project were:

Gail Kleiner (OSHA)
Sheldon Rabinovitz (NIOSH)
David Weitzman (EPA)
Glenn Wiltshire (USCG)

Jan Connery of Eastern Research Group, Arlington, Massachusetts, edited and coordinated production of the manual. Over 100 individuals and organizations also contributed substantially to the development of this manual by providing technical information and review. Although they are too numerous to name individually, the steering committee gratefully acknowledges their valuable contributions.

Notice

No warranty, guarantee, or representation, expressed or implied, is made by or on behalf of the U.S. Government as to the absolute correctness or sufficiency of any representation contained in this document. The U.S. Government assumes no responsibility in connection therewith, nor can it be assumed that all acceptable safety measures are contained in this or associated documents, or that other or additional measures may not be required under particular or exceptional conditions or circumstances.

The mention of a brand name product or company does not constitute endorsement by the National Institute for Occupational Safety and Health, the Occupational Safety and Health Administration, the U.S. Coast Guard, or the U.S. Environmental Protection Agency.

1. Introduction

In the past decade, industry, government, and the general public have become increasingly aware of the need to respond to the hazardous waste problem, which has grown steadily over the past 40 years. In 1980, Congress passed the Comprehensive Environmental Response, Compensation, and Liability Act (CERCLA) -- the Superfund law-to provide for "liability, compensation, cleanup, and emergency response for hazardous substances released into the environment and the cleanup of inactive waste disposal sites."

This manual is a guidance document for managers responsible for occupational safety and health programs at inactive hazardous waste sites. It assumes a basic knowledge of science and experience in occupational safety and health. It is the product of a four-agency committee (the National Institute for Occupational Safety and Health [NIOSH], the Occupational Safety and Health Administration [OSHA], the U.S. Coast Guard [USCG], and the U.S. Environmental Protection Agency [EPA]) mandated by CERCLA section 301(f) to study the problem of protecting the safety and health of workers at hazardous waste sites, and by CERCLA section 111(c)(6) to develop a program to protect the health and safety of employees involved in response to hazardous substance releases, removals, or remedial actions.

This manual is intended for federal, state, and local officials and their contractors. It may be used:

- As a planning tool by government or private individuals.
- As a management tool by upper level or field managers.
- As an educational tool to provide a comprehensive overview of all aspects of safety and health protection at hazardous waste sites.
- As a reference document for site personnel who need to review important aspects of health and safety.

This document is *not* a detailed industrial hygiene textbook or a comprehensive source book on occupational safety and health. It provides general guidance and should be used as a preliminary basis for developing a specific health and safety program. The appropriateness of the information presented should always be evaluated in light of site-specific conditions. Other sources and experienced individuals should be consulted as necessary for the detail needed to design and implement occupational safety and health programs at specific hazardous waste sites.

Although this manual cites federal regulations, it is not a definitive legal document and should not be taken as such. While it represents a cooperative effort of the four agencies to develop a document that blends their widely differing mandates, policies, and procedures in specific areas, the manual may not include elements of each agency's policies that should be considered when developing occupational safety and health programs for hazardous waste sites. Individuals who are responsible for the health and safety of workers at hazardous waste sites should obtain and comply with the most recent federal, state, and local regulations relevant to these sites, and are urged to consult with OSHA, EPA, and other appropriate federal, state, and local agencies.

This manual will be updated regularly. Please send comments and suggested revisions to any of these four organizations:

NIOSH
Hazardous Waste Program (C-17)
4676 Columbia Parkway
Cincinnati, OH 45226

OSHA
Directorate of Technical Support
200 Constitution Avenue, NW
Washington, DC 20210

USCG
Environmental Response Division (G-WER-2)
2100 Second Street, SW
Washington, DC 20593

EPA
Occupational Health and Safety Staff (PM-273)
401 M Street, SW
Washington, DC 20460

A separate manual that specifically addresses response to hazardous substances emergencies will be published at a later date. In the meantime, much of the information in this manual can be used in planning for response to emergencies involving hazardous substances.

2. Hazards

Contents

| | |
|--------------------|-----|
| Introduction | 2-1 |
| Chemical Exposure | 2-2 |
| Explosion and Fire | 2-3 |
| Oxygen Deficiency | 2-4 |
| Ionizing Radiation | 2-4 |
| Biological Hazards | 2-4 |
| Safety Hazards | 2-5 |
| Electrical Hazards | 2-5 |
| Heat Stress | 2-5 |
| Cold Exposure | 2-6 |
| Noise | 2-6 |

Introduction

Hazardous waste sites pose a multitude of health and safety concerns, any one of which could result in serious injury or death. These hazards are a function of the nature of the site as well as a consequence of the work being performed. They include:

- Chemical exposure.
- Fire and explosion.
- Oxygen deficiency.
- Ionizing radiation.
- Biologic hazards.
- Safety hazards.
- Electrical hazards.
- Heat stress.
- Cold exposure.
- Noise.

Several factors distinguish the hazardous waste site environment from other occupational situations involving hazardous substances. One important factor is the uncontrolled condition of the site. Even extremely hazardous substances do not endanger human health or safety if they are properly handled. However, improper control of these substances can result in a severe threat to site workers and to the general public.

Another factor is the large variety and number of substances that may be present at a site. Any individual location may contain hundreds or even thousands of chemicals. Frequently, an accurate assessment of all chemical hazards is impossible due to the large number of substances and the potential interactions among the substances. In addition, the identity of the substances on site is frequently unknown, particularly in the initial stages of an investigation. The Project Team Leader (see Chapter 3, *Planning and Organization*) will often be forced to select protective measures based on little or no information. Finally, workers are subject not only to the hazards of direct exposure, but also to dangers posed by the disorderly physical environment of hazardous waste sites and the stress of working in protective clothing.

The combination of all these conditions results in a working environment that is characterized by numerous and varied hazards which:

- May pose an immediate danger to life or health.
- May not be immediately obvious or identifiable.
- May vary according to the location on site and the task being performed.
- May change as site activities progress.

General categories of hazards that may be present at a site are described in this chapter. In approaching a site, it is prudent to assume that all these hazards are present until site characterization has shown otherwise. A site health and safety program, as described in the subsequent chapters of this manual, must provide comprehensive protection against all potential hazards and specific protection against individual known hazards. It should be continuously adapted to new information and changing site conditions.

Chemical Exposure

Preventing exposure to toxic chemicals is a primary concern at hazardous waste sites. Most sites contain a variety of chemical substances in gaseous, liquid, or solid form. These substances can enter the unprotected body by inhalation, skin absorption, ingestion, or through a puncture wound (injection). A contaminant can cause damage at the point of contact or can act systemically, causing a toxic effect at a part of the body distant from the point of initial contact.

Chemical exposures are generally divided into two categories: acute and chronic. Symptoms resulting from acute exposures usually occur during or shortly after exposure to a sufficiently high concentration of a contaminant. The concentration required to produce such effects varies widely from chemical to chemical. The term "chronic exposure" generally refers to exposures to "low" concentrations of a contaminant over a long period of time. The "low" concentrations required to produce symptoms of chronic exposure depend upon the chemical, the duration of each exposure, and the number of exposures. For a given contaminant, the symptoms of an acute exposure may be completely different from those resulting from chronic exposure.

For either chronic or acute exposure, the toxic effect may be temporary and reversible, or may be permanent (disability or death). Some chemicals may cause obvious symptoms such as burning, coughing, nausea, tearing eyes, or rashes. Other chemicals may cause health damage without any such warning signs (this is a particular concern for chronic exposures to low concentrations). Health effects such as cancer or respiratory disease may not become manifest for several years or decades after exposure. In addition, some toxic chemicals may be colorless and/or odorless, may dull the sense of smell, or may not produce any immediate or obvious physiological sensations. Thus, a worker's senses or feelings cannot be relied upon in all cases to warn of potential toxic exposure.

The effects of exposure not only depend on the chemical, its concentration, route of entry, and duration of exposure, but may also be influenced by personal factors such as the individual's smoking habits, alcohol consumption, medication use, nutrition, age, and sex (see Chapter 5, *Medical Program*).

An important exposure route of concern at a hazardous waste site is inhalation. The lungs are extremely vulnerable to chemical agents. Even substances that do not directly affect the lungs may pass through lung tissue into the bloodstream, where they are transported to other vulnerable areas of the body. Some toxic chemicals present in the atmosphere may not be detected by human senses, i.e., they may be colorless, odorless, and their toxic effects may not produce any immediate symptoms. Respiratory protection is therefore extremely important if

there is a possibility that the work-site atmosphere may contain such hazardous substances. Chemicals can also enter the respiratory tract through punctured eardrums. Where this is a hazard, individuals with punctured eardrums should be medically evaluated specifically to determine if such a condition would place them at unacceptable risk and preclude their working at the task in question.

Direct contact of the skin and eyes by hazardous substances is another important route of exposure. Some chemicals directly injure the skin. Some pass through the skin into the bloodstream where they are transported to vulnerable organs. Skin absorption is enhanced by abrasions, cuts, heat, and moisture. The eye is particularly vulnerable because airborne chemicals can dissolve in its moist surface and be carried to the rest of the body through the bloodstream (capillaries are very close to the surface of the eye). Wearing protective equipment, not using contact lenses in contaminated atmospheres (since they may trap chemicals against the eye surface), keeping hands away from the face, and minimizing contact with liquid and solid chemicals can help protect against skin and eye contact.

Although ingestion should be the least significant route of exposure at a site, it is important to be aware of how this type of exposure can occur. Deliberate ingestion of chemicals is unlikely, however, personal habits such as chewing gum or tobacco, drinking, eating, smoking cigarettes, and applying cosmetics on site may provide a route of entry for chemicals.

The last primary route of chemical exposure is injection, whereby chemicals are introduced into the body through puncture wounds (for example, by stepping or tripping and falling onto contaminated sharp objects). Wearing safety shoes, avoiding physical hazards, and taking common sense precautions are important protective measures against injection.

Explosion and Fire

There are many potential causes of explosions and fires at hazardous waste sites:

- Chemical reactions that produce explosion, fire, or heat.
- Ignition of explosive or flammable chemicals.
- Ignition of materials due to oxygen enrichment.
- Agitation of shock- or friction-sensitive compounds.
- Sudden release of materials under pressure.

Explosions and fires may arise spontaneously. However, more commonly, they result from site activities, such as moving drums, accidentally mixing incompatible chemicals, or introducing an ignition source (such as a spark from equipment) into an explosive or flammable environment. At hazardous waste sites, explosions and fires not only pose the obvious hazards of intense heat, open flame, smoke inhalation, and flying objects, but may also cause the release of toxic chemicals into the environment. Such releases can threaten both personnel on site and members of the general public living or working nearby. To protect against the hazard: have qualified personnel field monitor for explosive atmospheres and flammable vapors; keep all potential ignition sources away from an explosive or flammable environment; use non-sparking, explosion-proof equipment; and follow safe practices when performing any task that might result in the agitation or release of chemicals.

Oxygen Deficiency

The oxygen content of normal air at sea level is approximately 21 percent. Physiological effects of oxygen deficiency in humans are readily apparent when the oxygen concentration in the air decreases to 16 percent. These effects include impaired attention, judgment and coordination, and increased breathing and heart rate. Oxygen concentrations lower than 16 percent can result in nausea and vomiting, brain damage, heart damage, unconsciousness, and death. To take into account individual physiological responses and errors in measurement, concentrations of 19.5 percent oxygen or lower are considered to be indicative of oxygen deficiency.

Oxygen deficiency may result from the displacement of oxygen by another gas, or the consumption of oxygen by a chemical reaction. Confined spaces or low-lying areas are particularly vulnerable to oxygen deficiency and should always be monitored prior to entry. Qualified field personnel should always monitor oxygen levels and should use atmosphere-supplying respiratory equipment (see Chapter 8, *Personal Protective Equipment*) when oxygen concentrations drop below 19.5 percent by volume.

Ionizing Radiation

Radioactive materials emit one or more of three types of harmful radiation: alpha, beta, and gamma. Alpha radiation has limited penetration ability and is usually stopped by clothing and the outer layers of the skin. Alpha radiation poses little threat outside the body, but can be hazardous if materials that emit alpha radiation are inhaled or ingested. Beta radiation can cause harmful "beta burns" to the skin and damage the subsurface blood system. Beta radiation is also hazardous if materials that emit beta radiation are inhaled or ingested. Use of protective clothing, coupled with scrupulous personal hygiene and decontamination, affords good protection against alpha and beta radiation.

Gamma radiation easily passes through clothing and human tissue and can also cause serious permanent damage to the body. Chemical-protective clothing affords no protection against gamma radiation itself; however, use of respiratory and other protective equipment can help keep radiation-emitting materials from entering the body by inhalation, ingestion, injection, or skin absorption.

If levels of radiation above natural background are discovered (see Table 6-2 in Chapter 6), consult a health physicist. At levels greater than 2 mrem/hr, all site activities should cease until the site has been assessed by health physicists.

Biologic Hazards

Wastes from hospitals and research facilities may contain disease-causing organisms that could infect site personnel. Like chemical hazards, etiologic agents may be dispersed in the environment via water and wind. Other biologic hazards that may be present at a hazardous waste site include poisonous plants, insects, animals, and indigenous pathogens. Protective clothing and respiratory equipment can help reduce the chances of exposure. Thorough washing of any exposed body parts and equipment will help protect against infection.

Safety Hazards

Hazardous waste sites may contain numerous safety hazards such as:

- Holes or ditches.
- Precariously positioned objects, such as drums or boards that may fall.
- Sharp objects, such as nails, metal shards, and broken glass.
- Slippery surfaces.
- Steep grades.
- Uneven terrain.
- Unstable surfaces, such as walls that may cave in or flooring that may give way.

Some safety hazards are a function of the work itself. For example, heavy equipment creates an additional hazard for workers in the vicinity of the operating equipment. Protective equipment can impair a worker's agility, hearing, and vision, which can result in an increased risk of an accident.

Accidents involving physical hazards can directly injure workers and can create additional hazards, for example, increased chemical exposure due to damaged protective equipment, or danger of explosion caused by the mixing of chemicals. Site personnel should constantly look out for potential safety hazards, and should immediately inform their supervisors of any new hazards so that mitigative action can be taken.

Electrical Hazards

Overhead power lines, downed electrical wires, and buried cables all pose a danger of shock or electrocution if workers contact or sever them during site operations. Electrical equipment used on site may also pose a hazard to workers. To help minimize this hazard, low-voltage equipment with ground-fault interrupters and water-tight, corrosion-resistant connecting cables should be used on site. In addition, lightning is a hazard during outdoor operations, particularly for workers handling metal containers or equipment. To eliminate this hazard, weather conditions should be monitored and work should be suspended during electrical storms. An additional electrical hazard involves capacitors that may retain a charge. All such items should be properly grounded before handling. OSHA's standard 29 CFR Part 1910.137 describes clothing and equipment for protection against electrical hazards.

Heat Stress

Heat stress is a major hazard, especially for workers wearing protective clothing. The same protective materials that shield the body from chemical exposure also limit the dissipation of body heat and moisture. Personal protective clothing can therefore create a hazardous condition. Depending on the ambient conditions and the work being performed, heat stress can occur very rapidly --within as little as 15 minutes. It can pose as great a danger to worker health as chemical exposure. In its early stages, heat stress can cause rashes, cramps, discomfort and drowsiness, resulting in impaired functional ability that threatens the safety of both the individual and coworkers. Continued heat stress can lead to heat stroke and death. Avoiding overprotection, careful training and frequent monitoring of personnel who wear protective clothing, judicious

scheduling of work and rest periods, and frequent replacement of fluids can protect against this hazard. For further information on heat stress, see Chapter 8, *Personal Protective Equipment*.

Cold Exposure

Cold injury (frostbite and hypothermia) and impaired ability to work are dangers at low temperatures and when the wind-chill factor is low. To guard against them: wear appropriate clothing; have warm shelter readily available; carefully schedule work and rest periods, and monitor workers' physical conditions.

Noise

Work around large equipment often creates excessive noise. The effects of noise can include:

- Workers being startled, annoyed, or distracted.
- Physical damage to the ear, pain, and temporary and/ or permanent hearing loss.
- Communication interference that may increase potential hazards due to the inability to warn of danger and the proper safety precautions to be taken.

If employees are subjected to noise exceeding an 8-hour, time-weighted average sound level of 90 dBA (decibels on the A-weighted scale), feasible administrative or engineering controls must be utilized. In addition, whenever employee noise exposures equal or exceed an 8-hour, time-weighted average sound level of 85 dBA, employers must administer a continuing, effective hearing conservation program as described in OSHA regulation 29 CFR Part 1910.95.

3. Planning and Organization

Contents

| | |
|-----------------------------------|------|
| Introduction | 3-1 |
| Organizational Structure | 3-1 |
| Work Plan | 3-7 |
| Site Safety Plan | 3-8 |
| Safety Management and Inspections | 3-10 |
| References | 3-10 |

Introduction

Adequate planning is the first and the most critical element of hazardous waste site activities. By anticipating and taking steps to prevent potential hazards to health and safety, work at a waste site can proceed with minimum risk to workers and the public.

Three aspects of planning are discussed in this chapter: developing an overall organizational structure for site operations; establishing a comprehensive Work Plan that considers each specific phase of the operation; and developing and implementing a Site Safety and Health Plan (hereinafter referred to as Site Safety Plan in accordance with common usage). The organizational structure should identify the personnel needed for the overall operation, establish the chain-of-command, and specify the overall responsibilities of each employee. The Work Plan should establish the objectives of site operations and the logistics and resources required to achieve the goals. The Site Safety Plan should determine the health and safety concerns for each phase of the operation and define the requirements and procedures for worker and public protection.

A fourth important aspect of planning is coordinating with the existing response community. A national response organization was established by a Congressionally mandated National Contingency Plan to implement procedures for coordinating response to releases of hazardous substances into the environment. This National Contingency Plan establishes response teams composed of representatives of federal agencies and state and local governments [1]. A particularly important contact for hazardous waste site activities is the EPA-designated official responsible for coordinating federal activities related to site cleanup.

Planning should be viewed as an ongoing process: the cleanup activities and Site Safety Plan must be continuously adapted to new site conditions and new information. Thus, this chapter is intended to serve as a starting point for planning the response activities at hazardous waste sites.

Organizational Structure

An organizational structure that supports the overall objectives of the project should be developed in the first stage of planning. This structure should:

- Identify a leader who has the authority to direct all activities.
- Identify the other personnel needed for the project, and assign their general functions and responsibilities.

- Show lines of authority, responsibility, and communication.
- Identify the interface with the response community.

As the project progresses, it may be necessary to modify some organizational aspects of the project, such as personnel responsibilities and authorities, so that individual tasks can be performed as efficiently and safely as possible. Any changes to the overall organizational structure must be recorded in the appropriate parts of the Work or Site Safety Plans that are developed for individual phases or tasks and must be communicated to all parties involved.

Figure 3-1 presents one example of an organizational framework for a hazardous waste site response team. It shows the lines of authority for 24 categories of offsite and onsite personnel. The responsibilities and functions of each category are described in Tables 3-1 through 3-4. The onsite categories are divided into personnel that are essential for a safe and efficient response, and optional personnel that may be desirable in a large operation where responsibilities can be delegated to a greater number of people. As-needed personnel are specialists that are called upon for specific tasks, either off-site or on site.

This example is intended to illustrate the scope of responsibilities and functions that must be covered. The personnel categories described can be used as a starting point for designing an organizational structure appropriate to a particular situation. For smaller investigative and response efforts, single individuals may perform several of the functions described.

Regardless of the size of the effort, all response teams should include a Site Safety and Health Officer (hereinafter referred to as Site Safety Officer in accordance with common usage) responsible for implementing health and safety requirements. The Site Safety Officer should have ready access to other occupational health and safety professionals, particularly an industrial hygienist. Once an organizational system has been developed, all individuals responsible for establishing and enforcing health and safety requirements should be identified and their respective authorities clearly explained to all members of the response team.

One of the most critical elements in worker safety is the attitude of all levels of project management. A strong and visible commitment to worker safety must be present from the beginning of a project. This initial attitude sets the tone for the entire operation. The Site Safety Officer and the Project Team Leader must have the clear support of senior-level management for establishing, implementing, and enforcing safety programs from the outset of the project. The importance of management's attitude toward safety throughout the project cannot be overemphasized; site personnel are more likely to cooperate with safety programs if they sense a genuine concern on the part of management.

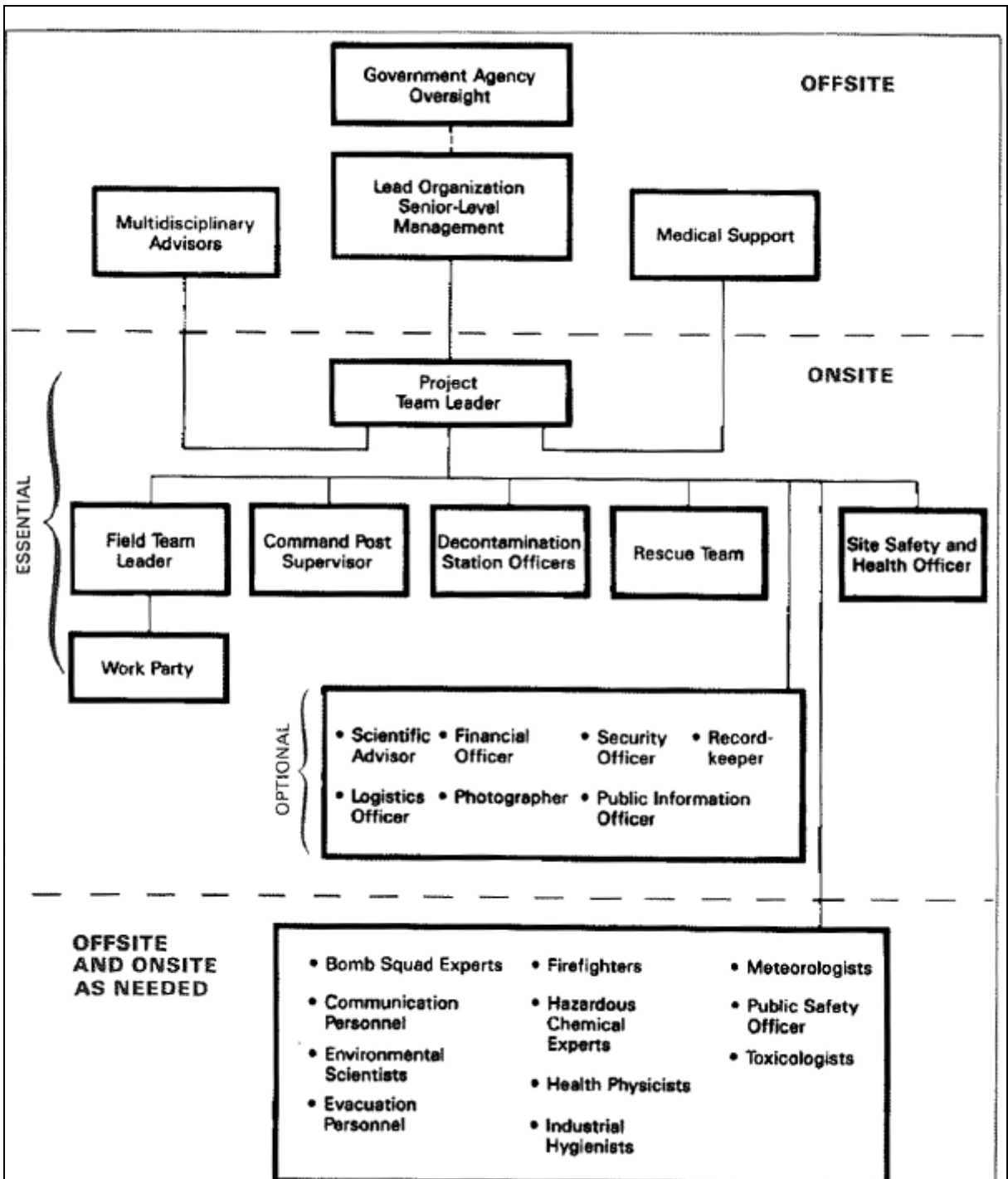

Figure 3-1. Generalized Approach to Personnel Organization for Site Investigation and Response.

Several organizational factors are indicators of successful worker safety programs. These factors include:

- Strong management commitment to safety, as defined by various actions reflecting management's support and involvement in safety activities.
- Close contact and interaction among workers, supervisors, and management enabling open communication on safety as well as other job-related matters.

Table 3-2. Onsite Essential Personnel

| TITLE | GENERAL DESCRIPTION | SPECIFIC RESPONSIBILITIES |
|---|---|--|
| Project Team Leader | Reports to upper-level management. Has authority to direct response operations. Assumes total control over site activities. | <ul style="list-style-type: none"> • Prepares and organizes the background review of the situation, the Work Plan, the Site Safety Plan, and the field team. • Obtains permission for site access and coordinates activities with appropriate officials. • Ensures that the Work Plan is completed and on schedule. • Briefs the field teams on their specific assignments. • Uses the Site Safety and Health Officer to ensure that safety and health requirements are met. • Prepares the final report and support files on the response activities. • Serves as the liaison with public officials. |
| Site Safety and Health Officer (hereinafter referred to as Site Safety Officer in accordance with common usage) | Advises the Project Team Leader on all aspects of health and safety on site. Recommends stopping work if any operation threatens worker or public health or safety. | <ul style="list-style-type: none"> • Selects protective clothing and equipment. • Periodically inspects protective clothing and equipment. • Ensures that protective clothing and equipment are properly stored and maintained. • Controls entry and exit at the Access Control Points. • Coordinates safety and health program activities with the Scientific Advisor. • Confirms each team member's suitability for work based on a physician's recommendation. • Monitors the work parties for signs of stress, such as cold exposure, heat stress, and fatigue. • Monitors onsite hazards and conditions. • Participates in the preparation of and implements the Site Safety Plan. • Conducts periodic inspections to determine if the Site Safety Plan is being followed. • Enforces the "buddy" system. • Knows emergency procedures, evacuation routes, and the telephone numbers of the ambulance, local hospital, poison control center, fire department, and police department. • Notifies, when necessary, local public emergency officials. • Coordinates emergency medical care. |
| Field Team Leader | May be the same person as the Project Team Leader and may be a member of the work party. Responsible for field team operations and safety. | <ul style="list-style-type: none"> • Manages field operations. • Executes the Work Plan and schedule. • Enforces safety procedures. • Coordinates with the Site Safety Officer in determining protection level. • Enforces site control. • Documents field activities and sample collection. • Serves as a liaison with public officials. |

| TITLE | GENERAL DESCRIPTION | SPECIFIC RESPONSIBILITIES |
|---|---|---|
| Command Post Supervisor | May be the same person as the Field Team Leader. Responsible for communications and emergency assistance. | <ul style="list-style-type: none"> • Notifies emergency response personnel by telephone or radio in the event of an emergency. • Assists the Site Safety Officer in rescue, if necessary. • Maintains a log of communication and site activities. • Assists other field team members in the clean areas, as needed. • Maintains line-of-sight and communication contact with the work parties via walkie-talkies, signal horns, or other means. |
| Decontamination Station Officer(s) | Responsible for decontamination procedures, equipment, and supplies. | <ul style="list-style-type: none"> • Sets up decontamination lines and the decontamination solutions appropriate for the type of chemical contamination on site. • Controls the decontamination of all equipment, personnel, and samples from the contaminated areas. • Assists in the disposal of contaminated clothing and materials. • Ensures that all required equipment is available. • Advises medical personnel of potential exposures and consequences. |
| Rescue Team | Used primarily on large sites with multiple work parties in the contaminated area. | <ul style="list-style-type: none"> • Stands by, partially dressed in protective gear, near hazardous work areas. • Rescues any worker whose health or safety is endangered. |
| Work Party | Depending on the size of the field team, any or all of the field team may be in the Work Party, but the Work Party should consist of at least two people. | <ul style="list-style-type: none"> • Safely completes the onsite tasks required to fulfill the Work Plan. • Complies with Site Safety Plan. • Notifies Site Safety Officer or supervisor of unsafe conditions. |

Overall, the most effective industrial safety programs are successful in dealing with "people" variables. Open communication among workers, supervisors, and management concerning worksite safety is essential.

The effective management of response actions at hazardous waste sites requires a commitment to the health and safety of the general public as well as to the onsite personnel. Prevention and containment of contaminant release into the surrounding community should be addressed in the planning stages of a project. Not only must the public be protected, they must also be made aware of the health and safety program and have confidence in it. To accomplish these goals, the Project Team Leader, or Public Information Officer under the supervision of the Project Team Leader, should establish community liaison well before any response action is begun, and should be in continuous contact with community leaders.

Table 3-3. Onsite Optional Personnel

| TITLE | GENERAL DESCRIPTION | SPECIFIC RESPONSIBILITIES |
|--------------------------------------|---|--|
| Scientific Advisor | Guides the Project Team Leader in scientific matters. | <ul style="list-style-type: none"> • Provides advice for: <ul style="list-style-type: none"> Field monitoring Scientific studies Sample collection Data interpretation Sample analysis Remedial plans |
| Logistics Officer | | <ul style="list-style-type: none"> • Plans and mobilizes the facilities, materials, and personnel required for the response. |
| Photographer | | <ul style="list-style-type: none"> • Photographs site conditions. • Archives photographs. |
| Financial/Contracting Officer | | <ul style="list-style-type: none"> • Provides financial and contractual support. |
| Public Information Officer | | <ul style="list-style-type: none"> • Releases information to the news media and the public concerning site activities. |
| Security Officer | | <ul style="list-style-type: none"> • Manages site security. |
| Recordkeeper | | <ul style="list-style-type: none"> • Maintains the official records of site activities. |

Work Plan

To ensure a safe response, a Work Plan describing anticipated cleanup activities must be developed before beginning onsite response actions. The Work Plan should be periodically reexamined and updated as new information about site conditions is obtained.

The following steps should be taken in formulating a comprehensive Work Plan:

- Review available information, including:
 - Site records
 - Waste inventories
 - Generator and transporter manifests
 - Previous sampling and monitoring data
 - Site photos
 - State and local environmental and health agency records
- Define work objectives.
- Determine methods for accomplishing the objectives, e.g., sampling plan, inventory, disposal techniques.
- Determine personnel requirements.
- Determine the need for additional training of personnel. Evaluate their current knowledge/skill level against the tasks they will perform and situations they may encounter (see Chapter 4, *Training*).
- Determine equipment requirements. Evaluate the need for special equipment or services, such as drilling equipment or heavy equipment and operators.

Preparation of the Work Plan requires a multidisciplinary approach, and may therefore require input from all levels of onsite and offsite management. Consultants may also be useful in developing sections of the Work Plan; for example, chemists, occupational health and safety professionals, and statisticians may be needed to develop the sampling plan.

Site Safety Plan

A Site Safety Plan, which establishes policies and procedures to protect workers and the public from the potential hazards posed by a hazardous waste site, must be developed before site activities proceed. The Site Safety Plan must provide measures to minimize accidents and injuries that may occur during normal daily activities or during adverse conditions such as hot or cold weather. This section describes the planning process for health and safety during normal site operations, i.e., non-emergency situations. Chapter 12 describes planning and response to site emergencies.

Development of a written Site Safety Plan helps ensure that all safety aspects of site operations are thoroughly examined prior to commencing field work. The Site Safety Plan should be modified as needed for every stage of site activity.

Because planning requires information, planning and site characterization should be coordinated. An initial Site Safety Plan should be developed so that the preliminary site assessment can proceed in a safe manner. The information from this assessment can then be used to refine the Site Safety Plan so that further site activities can proceed safely. Plans should be revised whenever new information about site hazards is obtained.

Development of a Site Safety Plan should involve both the offsite and onsite management and be reviewed by occupational and industrial health and safety experts, physicians, chemists, or other appropriate personnel.

At a minimum, the plan should:

- Name key personnel and alternates responsible for site safety (see Tables 3-1 through 3-4).
- Describe the risks associated with each operation conducted (see Chapter 6, *Site Characterization*).
- Confirm that personnel are adequately trained to perform their job responsibilities and to handle the specific hazardous situations they may encounter (see Chapter 4, *Training*).
- Describe the protective clothing and equipment to be worn by personnel during various site operations (see Chapter 8, *Personal Protective Equipment*).
- Describe any site-specific medical surveillance requirements (see Chapter 5, *Medical Program*).
- Describe the program for periodic air monitoring, personnel monitoring, and environmental sampling, if needed (see Chapter 6, *Site Characterization*, and Chapter 11, *Handling Drums and Other Containers*).
- Describe the actions to be taken to mitigate existing hazards (e.g., containment of contaminated materials) to make the work environment less hazardous.
- Define site control measures and include a site map (see Chapter 9, *Site Control*).
- Establish decontamination procedures for personnel and equipment (see Chapter 10, *Decontamination*).
- Set forth the site's Standard Operating Procedures (SOPs). SOPs are those activities that can be standardized (such as decontamination and respirator fit testing), and where a checklist can be used. These procedures should be:
 - Prepared in advance.
 - Based on the best available information, operational principles, and technical guidance.
 - Field-tested by qualified health and safety professionals, and revised as appropriate.

- Appropriate to the types of risk at that site. Formulated to be easy to understand and practice.
- Provided in writing to all site personnel, who should be briefed on their use. Included in training programs for site personnel.
- Set forth a Contingency Plan for safe and effective response to emergencies.

Appendix B provides a generic Site Safety Plan that can be adapted for hazardous waste site cleanup operations. The generic plan should be used as a guide, *not a standard*, for designing a Site Safety Plan.

Table 3-4. As-Needed Personnel

| TITLE | GENERAL DESCRIPTION | SPECIFIC RESPONSIBILITIES |
|---|---|--|
| Bomb Squad Explosion Experts | | <ul style="list-style-type: none"> • Advise on methods of handling explosive materials. • Assist in safely detonating or disposing of explosive materials. |
| Communication Personnel | Civil Defense organizations; local radio and television stations. Local emergency service networks. | <ul style="list-style-type: none"> • Provide communication to the public in the event of an emergency. • Provide communication links for mutual aid. |
| Environmental Scientists | Consultants from industry, government, universities, or other groups. | <ul style="list-style-type: none"> • Predict the movement of released hazardous materials through the atmosphere, geologic, and hydrologic environment. • Assess the effect of this movement on air, groundwater, and surface water quality. • Predict the exposure of people and the ecosystem to the materials. |
| Evacuation Personnel | Federal, state, and local public safety organizations. | <ul style="list-style-type: none"> • Help plan for public evacuation. • Mobilize transit equipment. • Assist in public evacuation. |
| Firefighters | | <ul style="list-style-type: none"> • Respond to fires that occur on site. • Stand by for response to potential fires. • Perform rescue. |
| Hazardous Chemical Experts | Consultants from industry, government, universities, or other groups. | <ul style="list-style-type: none"> • Advise on the properties of the materials on site • Advise on contaminant control methods. • Advise on the dangers of chemical mixtures that may result from site activities. • Provide immediate advice to those at the scene of a chemical-related emergency. |
| Health Physicists | | <ul style="list-style-type: none"> • Evaluate radiation health hazards and recommend appropriate action. |
| Industrial Hygienists | | <ul style="list-style-type: none"> • Conduct health hazard assessments. • Advise on adequate health protection. • Conduct monitoring tests to determine worker exposures to hazardous substances. |
| Meteorologists | | <ul style="list-style-type: none"> • Provide meteorological information. |
| Public Safety Personnel | The County Sheriff, industrial security forces, National Guard, police, etc. | <ul style="list-style-type: none"> • Control access to the site. |
| Toxicologists | | <ul style="list-style-type: none"> • Advise on toxicological properties and health effects of substances on site. • Provide recommendations on protection of worker health. |

Safety Meetings and Inspections

To ensure that the Site Safety Plan is being followed, the Site Safety Officer should conduct a safety meeting prior to initiating any site activity and before and after each work day. The purpose of these safety meetings is to:

- Describe the assigned tasks and their potential hazards.
- Coordinate activities.
- Identify methods and precautions to prevent injuries.
- Plan for emergencies.
- Describe any changes in the Site Safety Plan.
- Get worker feedback on conditions affecting safety and health.
- Get worker feedback on how well the Site Safety Plan is working.

The Site Safety Officer should also conduct frequent inspections of site conditions, facilities, equipment, and activities to determine whether the Site Safety Plan is adequate and being followed.

At a hazardous waste site, risks to workers can change quickly and dramatically when there are changes in:

- Work and other site activities.
- State of degradation of containers and containment structures.
- State of equipment maintenance.
- Weather conditions.

In order to make safety inspections effective, the following guidelines should be observed:

- Develop a checklist for each site, listing the items that should be inspected.
- Review the results of these inspections with supervisors and workers.
- Reinspect any identified problems to ensure that they have been corrected.
- Document all inspections and subsequent follow-up actions. Retain these records until site activities are completed and as long as required by regulatory agencies.

The minimum frequency at which inspections should occur varies with the characteristics of the site and the equipment used on site. Factors that need to be considered are:

- The severity of risk on site.
- Regulatory requirements.
- Operation and maintenance requirements.
- The expected effective lifetime of clothing, equipment, vehicles, and other items.
- Recommendations based on professional judgment, laboratory test results, and field experience.

References

1. National Oil and Hazardous Substances Pollution Contingency Plan, 40 CFR Part 300.

4. Training

Contents

| | |
|--------------------|-----|
| Introduction | 4-1 |
| Training Programs | 4-2 |
| Record of Training | 4-4 |

Introduction

Anyone who enters a hazardous waste site must recognize and understand the potential hazards to health and safety associated with the cleanup of that site. Personnel actively involved in cleanup must be thoroughly familiar with programs and procedures contained in the Site Safety Plan (see Chapter 3, *Planning and Organization*) and must be trained to work safely in contaminated areas. Visitors to a site must receive adequate training on hazard recognition and on the site's Standard Operating Procedures to enable them to conduct their visit safely.

The objectives of training programs for employees involved in hazardous waste site activities are:

- To make workers aware of the potential hazards they may encounter.
- To provide the knowledge and skills necessary to perform the work with minimal risk to worker health and safety.
- To make workers aware of the purpose and limitations of safety equipment.
- To ensure that workers can safely avoid or escape from emergencies.

The level of training provided should be consistent with the worker's job function and responsibilities. The training program should involve both classroom instruction in a wide range of health and safety topics and "hands-on" practice. Hands-on instruction should consist of drills in the field that simulate site activities and conditions. Any training program for work around hazardous substances should also incorporate onsite experience under the direct supervision of trained, experienced personnel.

All training information should be presented in clear, concise language. Particularly important information, such as the Standard Operating Procedures, should be provided in writing. A variety of teaching aids (i.e., films, tapes, slides, etc.) should be used, and lecture sessions should be interspersed with class participation and hands-on training. All employees should also complete



The training program should involve field drills that simulate emergency situations. Here workers wearing Level A personal protective equipment repair a leaking pipe as part of a training exercise.

refresher training, at least annually, to reemphasize the initial training and to update workers on any new policies or procedures.

Training Programs

Employees should not engage in field activities until they have been trained to a level commensurate with their job function and responsibilities and with the degree of anticipated hazards. Specific recommendations for the areas to be covered in training sessions are given in Table 4-1.

General site workers, such as equipment operators, general laborers, technicians, and other supervised personnel, should attend training sessions that apply to their individual jobs and responsibilities, as well as training sessions that provide an overview of the site hazards and the means of controlling those hazards. Their training should include classroom instruction in the following subject areas, depending on their individual jobs:

- Site Safety Plan.
- Safe work practices.
- Nature of anticipated hazards.
- Handling emergencies and self-rescue.
- Rules and regulations for vehicle
- Safe use of field equipment.
- Handling, storage, and transportation of hazardous materials.
- Employee rights and responsibilities.
- Use, care, and limitations of personal protective clothing and equipment (see *Training* section of Chapter 8).
- Safe sampling techniques.

In addition to classroom instruction, general site workers should engage in actual field activities under the direct supervision of a trained, experienced supervisor.

Some general site workers who may be exposed to unique hazards or who may occasionally supervise others should receive additional training in the following subject areas:

- Site surveillance.
- Site Safety Plan development.
- Use and decontamination of fully encapsulating personal protective clothing and equipment.
- Use of instruments to measure explosivity, radioactivity, etc.
- Safe use of specialized equipment.
- Topics specific to identified site activities.

Onsite management and supervisors, such as Project Team Leaders, who are responsible for directing others, should receive the same training as the general site workers for whom they are responsible, as well as additional training to enhance their ability to provide guidance and make informed decisions. This additional training should include:

- Management of hazardous waste site cleanup operations.
- Management of the site work zones (see Chapter 9, *Site Control*).

- How to communicate with the press and local community.

Health and safety staff with specific responsibilities for health and safety guidance on site should be familiar with the training provided to general site workers and their supervisors, and should receive advanced training in health and safety issues, policies, and techniques.

Visitors to the site (including elected and appointed officials, reporters, senior-level management, and other interested parties) must also receive a briefing on safety. These visitors should not be permitted in the Exclusion Zone (see Chapter 9, *Site Control* unless they have been trained, fit-tested, and medically approved for respirator use. All other visitors should not enter the Exclusion Zone; rather, they should observe site conditions from the clean area, e.g., using binoculars.

Table 4-1. Recommended Training by Job Category^a

| TRAINING TOPIC | EMPHASIS OF TRAINING | GENERAL SITE WORKER | ONSITE MANAGEMENT AND SUPERVISORS | HEALTH AND SAFETY STAFF | VISITORS |
|---|--|---------------------|-----------------------------------|-------------------------|----------|
| Biology, Chemistry, and Physics of Hazardous Materials | Chemical and physical properties; chemical reactions; chemical compatibilities. | R | R | R | |
| Toxicology | Dosage, routes of exposure, toxic effects, immediately dangerous to life or health (IDLH) values, permissible exposure limits (PELs), recommended exposure limits (RELs), threshold limit values (TLVs). | R | R | R | |
| Industrial Hygiene | Selection and monitoring of personal protective clothing and equipment. | | R | R | |
| | Calculation of doses and exposure levels; evaluation of hazards; selection of worker health and safety protective measures. | | R | R | |
| Rights and Responsibilities of Workers Under OSHA | Applicable provisions of Title 29 of the Code of Federal Regulations (the OSH Act). | R | R | R | |
| Monitoring Equipment | Functions, capabilities, selection, use, limitations, and maintenance. | R | R | R | |
| Hazard Evaluation | Techniques of sampling and assessment. | | R | R | |
| | Evaluation of field and lab results. | | R | R | |
| | Risk assessment. | | O | R | |
| Site Safety Plan | Safe practices, safety briefings and meetings, Standard Operating Procedures, site safety map. | R | R | R | R |
| Standard Operating Procedures (SOPs) | Hands on practice. | R | R | R | |
| | Development and compliance. | | | | |

| TRAINING TOPIC | EMPHASIS OF TRAINING | GENERAL SITE WORKER | ONSITE MANAGEMENT AND SUPERVISORS | HEALTH AND SAFETY STAFF | VISITORS |
|---|--|---------------------|-----------------------------------|-------------------------|----------|
| Engineering Controls | The use of barriers, isolation, and distance to minimize hazards. | R | R | R | |
| Personal Protective Clothing and Equipment (PPE) | Assignment, sizing, fit-testing, maintenance, use, limitations, and hands-on training. | R | R | R | R |
| | Selection of PPE. | | O | R | |
| | Ergonomics. | | | R | |
| Medical Program | Medical monitoring, first aid, stress recognition. | R | R | R | |
| | Advanced first aid, cardiopulmonary resuscitation (CPR); emergency drills. | O | R | R | |
| | Design, planning, and implementation. | | | R | |
| Decontamination | Hands-on training using simulated field conditions. | R | R | R | |
| | Design and maintenance. | R | R | R | |
| Legal and Regulatory Aspects | Applicable safety and health regulations (OSHA, EPA, etc.) | O | R | R | |
| Emergencies | Emergency help and self-rescue; emergency drills. | R | R | R | |
| | Response to emergencies; follow-up investigation and documentation. | | R | R | |

^aR = Recommended.

O = Optional.

Record of Training

A record of training should be maintained in each employees personnel file to confirm that every person assigned to a task has had adequate training for that task, and that every employee's training is up-to-date.

5. Medical Program

Contents

| | |
|-------------------------------------|------|
| Introduction | 5-1 |
| Developing a Program | 5-2 |
| Pre-Employment Screening | 5-8 |
| Determination of Fitness for Duty | 5-9 |
| Baseline Data for Future Exposures | 5-9 |
| Sample Pre-Employment Examination | 5-10 |
| Periodic Medical Examinations | 5-12 |
| Periodic Screening | 5-12 |
| Sample Periodic Medical Examination | 5-13 |
| Termination Examination | 5-13 |
| Emergency Treatment | 5-13 |
| Non-Emergency Treatment | 5-15 |
| Medical Records | 5-15 |
| Program Review | 5-16 |
| References | 5-16 |

Introduction

Workers handling hazardous wastes can experience high levels of stress. Their daily tasks may expose them to toxic chemicals, safety hazards, biologic hazards, and radiation. They may develop heat stress while wearing protective equipment or working under temperature extremes, or face life-threatening emergencies such as explosions and fires. Therefore, a medical program is essential to assess and monitor workers' health and fitness both prior to employment and during the course of work; to provide emergency and other treatment as needed; and to keep accurate records for future reference. In addition, OSHA recommends a medical evaluation for employees required to wear a respirator (29 CFR Part 1910.134[b][10]), and certain OSHA standards include specific medical requirements (e.g., 29 CFR Part 1910.95 and 29 CFR Parts 1910.1001 through 1910.1045). Information from a site medical program may also be used to conduct future epidemiological studies; to adjudicate claims; to provide evidence in litigation; and to report workers' medical conditions to federal, state, and local agencies, as required by law.

This chapter presents general guidelines for designing a medical program for personnel at hazardous waste sites. It includes information and sample protocols for pre-employment screening and periodic medical examinations, guidelines for emergency and non-emergency treatment, and recommendations for program record-keeping and review. In addition, it supplies a table of some common chemical toxicants found at hazardous waste sites with recommended medical monitoring procedures.

The recommendations in this chapter assume that workers will have adequate protection from exposures through administrative and engineering controls, and appropriate personal protective equipment and decontamination procedures, as described elsewhere in this manual. Medical surveillance should be used to complement other controls.

Developing a Program

A medical program should be developed for each site based on the specific needs, location, and potential exposures of employees at the site. The program should be designed by an experienced occupational health physician or other qualified occupational health consultant in conjunction with the Site Safety Officer. The director of a site medical program should be a physician who is board-certified in occupational medicine or a medical doctor who has had extensive experience managing occupational health services. A director and/or examining physician with such qualifications may be difficult to find, due to the shortage of doctors trained in occupational medicine in remote geographic areas where many hazardous waste sites are located. If an occupational health physician is not available, the site medical program may be managed, and relevant examinations performed, by a local physician with assistance from an occupational medicine consultant. These functions may also be performed by a qualified Registered Nurse, preferably an Occupational Health Nurse, under the direction of a suitably qualified physician who has responsibility for the program.¹

All medical test analyses should be performed by a laboratory that has demonstrated satisfactory performance in an established inter-laboratory testing program [1]. The clinical or diagnostic laboratory to which samples are sent should meet either (1) minimum requirements under the Clinical Laboratories Improvement Act of 1967 (42 CFR Part 74 Subpart M Section 263[a]), or (2) the conditions for coverage under Medicare. These programs are administered by the Health Care Financing Administration (HCFA), U.S. Department of Health and Human Services (DHHS).

A site medical program should provide the following components:

- Surveillance:
 - Pre-employment screening.
 - Periodic medical examinations (and follow-up examinations when appropriate).
 - Termination examination.
- Treatment:
 - Emergency
 - Non-emergency (on a case-by-case basis)
- Record-keeping.
- Program review.

Table 5-1 outlines a recommended medical program; screening and examination protocols are described in the following sections. These recommendations are based on known health risks for hazardous waste workers, a review of available data on their exposures, and an assessment of several established medical programs. Because conditions and hazards vary considerably at each site, only general guidelines are given.

The effectiveness of a medical program depends on active worker involvement. In addition, management should have a firm commitment to worker health and safety, and is encouraged to express this commitment not only by medical surveillance and treatment, but also through management directives and informal encouragement of employees to maintain good health through exercise, proper diet, and avoidance of tobacco, alcohol abuse and drug abuse. In particular, management should:

- Urge prospective employees to provide a complete and detailed occupational and medical history.

¹ Certified, state-licensed (where required) Physician's Assistants may also perform these examinations if a physician is available on the premises.

- Assure employees of confidentiality.
- Require workers to report any suspected exposures, regardless of degree.
- Require workers to bring any unusual physical or psychological conditions to the physician's attention. Employee training should emphasize that vague disturbances or apparently minor complaints (such as skin irritation or headaches) may be important.

When developing an individual program, site conditions must be considered and the monitoring needs of each worker should be determined based on the worker's medical and occupational history, as well as current and potential exposures on site. The routine job tasks of each worker should be considered. For instance, a heavy equipment operator exposed to significant noise levels would require a different monitoring protocol from a field sample collector with minimal noise exposure. Likewise, an administrator may only need a pre-employment screening for ability to wear personal protective equipment-if this is an occasional requirement-rather than a more comprehensive program.

The potential exposures that may occur at a site must also be considered. While it is often impossible to identify every toxic substance that exists at each hazardous waste site, certain types of hazardous substances or chemicals are more likely to be present than others. Some of these are:

- Aromatic hydrocarbons.
- Asbestos (or asbestiform particles).
- Dioxin.
- Halogenated aliphatic hydrocarbons.
- Heavy metals.
- Herbicides.
- Organochlorine insecticides.
- Organophosphate and carbamate insecticides.
- Polychlorinated biphenyls (PCBs).

Table 5-2 lists these groups, with representative compounds, uses, health effects, and available medical monitoring procedures.

In compiling a testing protocol, bear in mind that standard occupational medical tests were developed in factories and other enclosed industrial environments, and were based on the presence of specific identifiable toxic chemicals and the possibility of a significant degree of exposure. Some of these tests may not be totally appropriate for hazardous waste sites, since available data suggest that site workers have low-level exposures to many chemicals concurrently, plus brief high-level exposure to some chemicals [2]. In addition, most testing recommendations, even those for specific toxic substances, have not been critically evaluated for efficacy.

Another important factor to consider is that risk can vary, not only with the type, amount and duration of exposure, but also with individual factors such as age, sex, weight, stress, diet, susceptibility to allergic-type reactions, medications taken, and offsite exposures (e.g., in hobbies such as furniture refinishing and automotive body work).

Table 5-1. Recommended Medical Program

| COMPONENT | RECOMMENDED | OPTIONAL |
|--------------------------------------|--|--|
| Pre-Employment Screening | <ul style="list-style-type: none"> • Medical history. • Occupational history. • Physical examination. • Determination of fitness to work wearing protective equipment. • Baseline monitoring for specific exposures. | <ul style="list-style-type: none"> • Freezing pre-employment serum specimen for later testing (limited to specific situations, see Baseline Date for Future Exposures in this chapter). |
| Periodic Medical Examinations | <ul style="list-style-type: none"> • Yearly update of medical and occupational history; yearly physical examination; testing based on (1) examination results, (2) exposures, and (3) job class and task. • More frequent testing based on specific exposures. | <ul style="list-style-type: none"> • Yearly testing with routine medical tests. |
| Emergency Treatment | <ul style="list-style-type: none"> • Provide emergency first aid on site. • Develop liaison with local hospital and medical specialists. • Arrange for decontamination of victims. • Arrange in advance for transport of victims. • Transfer medical records; give details of incident and medical history to next care provider. | |
| Non-emergency Treatment | <ul style="list-style-type: none"> • Development mechanism for non-emergency health care. | |
| Recordkeeping and Review | <ul style="list-style-type: none"> • Maintain and provide access to medical records in accordance with OSHA and state regulations. • Report and record occupational injuries and illnesses. • Review Site Safety Plan regularly to determine if additional testing is needed. • Review program periodically. Focus on current site hazards, exposures, and industrial hygiene standards. | |

Table 5-2. Common Chemical Toxicants Found at Hazardous Waste Sites, Their Health Effects and Medical Monitoring

| HAZARDOUS SUBSTANCE OR CHEMICAL GROUP | COMPOUNDS | USES | TARGET ORGANS | POTENTIAL HEALTH EFFECTS | MEDICAL MONITORING |
|--|---|---|---|---|---|
| Aromatic Hydrocarbons | Benzene Ethyl benzene Toluene Xylene | Commercial solvents and intermediates for synthesis in the chemical and pharmaceutical industries. | Blood Bone marrow CNS ^a Eyes Respiratory system Skin Liver Kidney | All cause: CNS ^a depression: decreased alertness, headache, sleepiness, loss of consciousness. Defatting dermatitis. Benzene suppresses bone-marrow function, causing blood changes. Chronic exposure can cause leukemia. Note: Because other aromatic hydrocarbons may be contaminated with benzene during distillation, benzene-related health effects should be considered when exposure to any of these agents is suspected. | Occupational/ general medical history emphasizing prior exposure to these or other toxic agents. Medical examination with focus on liver, kidney, nervous system, and skin. Laboratory testing: CBC ^b Platelet count Measurement of kidney and liver function. |
| Asbestos (or asbestiform particles) | | A variety of industrial uses, including: Building Construction Cement work Insulation Fireproofing Pipes and ducts for water, air, and chemicals Automobile brake pads and linings | Lungs Gastrointestinal system | Chronic effects: Lung cancer Mesothelioma Asbestosis Gastrointestinal malignancies Asbestos exposure coupled with cigarette smoking has been shown to have a synergistic effect in the development of lung cancer. | History and physical examination should focus on the lungs and gastrointestinal system. Laboratory tests should include a stool test for occult blood evaluation as a check for possible hidden gastrointestinal malignancy. A high quality chest X-ray and pulmonary function test may help to identify long-term changes associated with asbestos diseases; however, early identification of low-dose exposure is unlikely. |
| Dioxin (see Herbicides) | | | | | |

| HAZARDOUS SUBSTANCE OR CHEMICAL GROUP | COMPOUNDS | USES | TARGET ORGANS | POTENTIAL HEALTH EFFECTS | MEDICAL MONITORING |
|---|---|---|---|--|---|
| Halogenated Aliphatic Hydrocarbons | Carbon tetrachloride Chloroform Ethyl bromide Ethyl chloride Ethylene dibromide Ethylene dichloride Methyl chloride Methyl chloroform Methylene chloride Tetrachloroethane Tetrachloroethylene (perchloroethylene) Trichloroethylene Vinyl chloride | Commercial solvents and intermediates in organic synthesis. | CNS ^a Kidney Liver Skin | All cause: CNS ^a depression: decreased alertness, headaches, sleepiness, loss of consciousness. Kidney changes: decreased urine flow, swelling (especially around the eyes), anemia Liver changes: fatigue, malaise, dark urine, liver enlargement, jaundice. Vinyl chloride is a known carcinogen; several others in this group are potential carcinogens. | Occupational/general medical history emphasizing prior exposure to these or other toxic agents. Medical examination with focus on liver, kidney, nervous system, and skin. Laboratory testing for liver and kidney function; carboxy-hemoglobin where relevant. |
| Heavy Metals | Arsenic Beryllium Cadmium Chromium Lead Mercury | Wide variety of industrial and commercial users. | Multiple organs and systems including: Blood Cardiopulmonary Gastrointestinal Kidney Liver Lung CNS ^a Skin | All are toxic to the kidneys. Each heavy metal has its own characteristic symptom cluster. For example, lead causes decreased mental ability, weakness (especially hands), headache, abdominal cramps, diarrhea, and anemia. Lead can also affect the bloodforming mechanism, kidneys, and the peripheral nervous system. Long-term effects ^c also vary. Lead toxicity can cause permanent kidney and brain damage; cadmium can cause kidney or lung disease. Chromium, beryllium, arsenic, and cadmium have been implicated as human carcinogens. | History-taking and physical exam: search for symptom clusters associated with specific metal exposures, e.g., for lead look for neurological deficit, anemia, and gastrointestinal symptoms. Laboratory testing: Measurement of metallic content in blood, urine, and tissues (e.g., blood lead level; urine screen for arsenic, mercury, chromium, and cadmium). CBC ^b Measurement of kidney function, and liver function where relevant. Chest X-ray or pulmonary function testing where relevant. |

| HAZARDOUS SUBSTANCE OR CHEMICAL GROUP | COMPOUNDS | USES | TARGET ORGANS | POTENTIAL HEALTH EFFECTS | MEDICAL MONITORING |
|---------------------------------------|---|---------------------|---|--|---|
| Herbicides | Chlorophenoxy compounds: 2,4-dichlorophenoxyacetic acid (2,4-D) 2,4,5-trichlorophenoxyacetic acid (2,4,5-T) Dioxin (tetrachloro-dibenzo-p-dioxin, TCDD), which occurs at a trace contaminant in these compounds, poses the most serious health risk. | Vegetation control. | Kidney Liver CNS ^a Skin | Chlorophenoxy compounds can cause chloracne, weakness or numbness of the arms and legs, and may result in long-term nerve damage. Dioxin causes chloracne and may aggravate pre-existing liver and kidney diseases. | History and physical exam should focus on the skin and nervous system. Laboratory tests include: Measurement of liver and kidney function, where relevant. Urinalysis. |
| Organochlorine Insecticides | Chlorinated ethanes: DDT Cyclodienes: Aldrin Chlordane Dieldrin Endrin Chlorocyclohexanes: Lindane | Pest control. | Kidney Liver CNS ^a | All cause acute symptoms of apprehension, irritability, dizziness, disturbed equilibrium, tremor, and convulsions. Cyclodienes may cause convulsions without any other initial symptoms. Chlorocyclohexanes can cause anemia. Cyclodienes and chlorocyclohexanes cause liver toxicity and can cause permanent kidney damage. | History and physical exam should focus on the nervous system. Laboratory tests include: Measurement of kidney and liver function. CBC ^b for exposure to chlorocyclohexanes. |

| HAZARDOUS SUBSTANCE OR CHEMICAL GROUP | COMPOUNDS | USES | TARGET ORGANS | POTENTIAL HEALTH EFFECTS | MEDICAL MONITORING |
|--|---|----------------------------------|---|--|---|
| Organo-phosphate and Carbamate Insecticides | Organophosphate: Diazinon Dichlorovos Dimethoate Trichlorfon Malathion Methyl parathion Parathion Carbamate: Aldicarb Baygon Zectran | Pest control. | CNS ^a Liver Kidney | All cause a chain of internal reactions leading to neuromuscular blockage. Depending on the extent of poisoning, acute symptoms range from headaches, fatigue, dizziness, increased salivation and crying, profuse sweating, nausea, vomiting, cramps, and diarrhea to tightness in the chest, muscle twitching, and slowing of the heartbeat. Severe cases may result in rapid onset of unconsciousness and seizures. A delayed effect may be weakness and numbness in the feet and hands. Long-term, permanent nerve damage is possible. | Physical exam should focus on the nervous system. Laboratory tests should include: RBC ^d cholinesterase levels for recent exposure (plasma cholinesterase for acute exposures). Measurement of delayed neurotoxicity and other effects. |
| Polychlorinated Biphenyls (PCBs) | | Wide variety of industrial uses. | Liver CNS ^a (speculative) Respiratory system (speculative) Skin | Various skin ailments, including chloracne; may cause liver toxicity; carcinogenic to animals. | Physical exam should focus on the skin and liver. Laboratory tests include: Serum PCB levels. Triglycerides and cholesterol. Measurement of liver function. |

^aCNS = Central nervous system

^bCBC = Complete blood count.

^cLong-term effects generally manifest in 10 to 30 years.

^dRBC=Red blood count.

Pre-employment Screening

Pre-employment screening has two major functions: (1) determination of an individual's fitness for duty, including the ability to work while wearing protective equipment, and (2) provision of baseline data for comparison with future medical data. These functions are discussed below. In addition, a sample pre-employment examination is described.

Determination of Fitness for Duty

Workers at hazardous waste sites are often required to perform strenuous tasks (e.g., moving 55-gallon drums) and wear personal protective equipment, such as respirators and protective clothing, that may cause heat stress and other problems (see Chapter 8 for details). To ensure that prospective employees are able to meet work requirements, the pre-employment screening should focus on the following areas:

Occupational and Medical History

- Make sure the worker fills out an occupational and medical history questionnaire. Review the questionnaire before seeing the worker. In the examining room, discuss the questionnaire with the worker, paying special attention to prior occupational exposures to chemical and physical hazards.
- Review past illnesses and chronic diseases, particularly atopic diseases such as eczema and asthma, lung diseases, and cardiovascular disease.
- Review symptoms, especially shortness of breath or labored breathing on exertion, other chronic respiratory symptoms, chest pain, high blood pressure, and heat intolerance.
- Identify individuals who are vulnerable to particular substances (e.g., someone with a history of severe asthmatic reaction to a specific chemical).
- Record relevant lifestyle habits (e.g., cigarette smoking, alcohol and drug use) and hobbies.

Physical Examination

- Conduct a comprehensive physical examination of all body organs, focussing on the pulmonary, cardiovascular, and musculoskeletal systems.
- Note conditions that could increase susceptibility to heat stroke, such as obesity and lack of physical exercise.
- Note conditions that could affect respirator use, such as missing or arthritic fingers, facial scars, dentures, poor eyesight, or perforated ear drums.

Ability to Work While Wearing Protective Equipment [3]

- Disqualify individuals who are clearly unable to perform based on the medical history and physical exam (e.g., those with severe lung disease, heart disease, or back or orthopedic problems).
- Note limitations concerning the worker's ability to use protective equipment (e.g., individuals who must wear contact lenses cannot wear full-face piece respirators).
- Provide additional testing (e.g., chest X-ray, pulmonary function testing, electrocardiogram) for ability to wear protective equipment where necessary.
- Base the determination on the individual worker's profile (e.g., medical history and physical exam, age, previous exposures and testing).
- Make a written assessment of the worker's capacity to perform while wearing a respirator, if wearing a respirator is a job requirement. Note that the Occupational Safety and Health Administration (OSHA) respirator standard (29 CFR Part 1910.134) states that no employee should be assigned to a task that requires the use of a respirator unless it has been determined that the person is physically able to perform under such conditions.

Baseline Data for Future Exposures

Pre-employment screening can be used to establish baseline data to subsequently verify the efficacy of protective assures and to later determine if exposures have adversely affected the worker. Baseline testing may include both medical screening tests and biologic monitoring tests. The latter (e.g., blood lead level) may be useful for ascertaining pre-exposure levels of specific substances to which the worker may be exposed and for which reliable tests are available. Given the problem in predicting significant

exposures for these workers, there are no clear guidelines for prescribing specific tests. The following approach identifies the types of tests that may indicated:

- A battery of tests based on the worker's past occupational and medical history and an assessment of significant potential exposures. See Table 5-3 for examples of tests frequently performed by occupational physicians.
- Standard established testing for specific toxicants in situations where workers may receive significant exposures to these agents. For example, long-term exposure during cleanup of a polychlorinated biphenyls (PCB) waste facility can be monitored with pre-employment and periodic serum PCB testing [4]. Standard procedures are available for determining levels of other substances, e.g., lead, cadmium, arsenic, and organophosphate pesticides.
- Where applicable, pre-employment blood specimens and serum frozen for later testing. (PCBs and some pesticides are examples of agents amenable to such monitoring.)

Table 5-3. Tests Frequently Performed by Occupational Physicians

| FUNCTION | TEST | EXAMPLE |
|------------------------------------|--------------|--|
| Liver: | | |
| General | Blood tests | Total protein, albumin, globulin, total bilirubin (direct bilirubin if total is elevated). |
| Obstruction | Enzyme test | |
| Cell injury | Enzyme tests | Alkaline phosphatase. Gamma glutamyl transpeptidase (GGTP), lactic dehydrogenase (LDH), serum glutamic-Oxaloacetic transaminase (SGOT), serum glutamic-pyruvic transaminase (SGPT). |
| Kidney: | | |
| General | Blood tests | Blood urea nitrogen (BUN), creatinine, uric acid. |
| Multiple Systems and Organs | Urinalysis | Including color; appearance; specific gravity; pH; qualitative glucose, protein, bile, and acetone; occult blood; microscopic examination of centrifuged sediment. |
| Blood-Forming Function | Blood tests | Complete blood count (CBC) with differential and platelet evaluation, including white cell count (WBC), red blood count (RBC), hemoglobin (HGB), hematocrit or packed cell volume (HCT), and desired erythrocyte indices. Reticulocyte count may be appropriate if there is a likelihood of exposure to hemolytic chemicals. |

Sample Pre-Employment Examination

Occupational and Medical History

- Do a complete medical history emphasizing these systems: nervous, skin, lung, blood-forming, cardiovascular, gastrointestinal, genitourinary, reproductive, ear, nose, and throat.

Physical Examination

Include at least the following:

- Height, weight, temperature, pulse, respiration, and blood pressure.
- Head, nose, and throat.
- Eyes. Include vision tests that measure refraction, depth perception, and color vision. These tests should be administered by a qualified technician or physician. Vision quality is essential to safety, the accurate reading of instruments and labels, the avoidance of physical hazards, and for appropriate response to color-coded labels and signals.
- Ears. Include audiometric tests, performed at 500, 1,000, 2,000, 3,000, 4,000, and 6,000 hertz (Hz) pure tone in an approved booth (see requirements listed in 29 CFR Part 1910.95, Appendix D). Tests should be administered by a qualified technician, and results read by a certified audiologist or a physician familiar with audiometric evaluation. The integrity of the eardrum should be established since perforated eardrums can provide a route of entry for chemicals into the body. The physician evaluating employees with perforated eardrums should consider the environmental conditions of the job and discuss possible specific safety controls with the Site Safety Officer, industrial hygienist, and/or other health professionals before deciding whether such individuals can safely work on site.
- Chest (heart and lungs).
- Peripheral vascular system.
- Abdomen and rectum (including hernia exam).
- Spine and other components of the musculoskeletal system.
- Genitourinary system.
- Skin.
- Nervous system.

Tests:

- Blood.
- Urine.
- A 14 x 17-inch posterior/anterior view chest X-ray, with lateral or oblique views only if indicated or if mandated by state regulations. The X-ray should be taken by a certified radiology technician and interpreted by a board-certified or board-eligible radiologist. Chest X-rays taken in the last 12-month period, as well as the oldest chest X-ray available, should be obtained and used for comparison. Chest X-rays should not be repeated more than once a year, unless otherwise determined by the examining physician.

Ability to Perform While Wearing Protective Equipment

To determine a worker's capacity to perform while wearing protective equipment, additional tests may be necessary, for example:

- **Pulmonary function testing.** Measurement should include forced expiratory volume in 1 second (FEV₁), forced vital capacity (FVC), and FEV₁-to-FVC ratio, with interpretation and comparison to, normal predicted values corrected for age, height, race, and sex. Other factors such as FEF, MEFR, MVV, FRC, RV, and TLC¹ may be included for additional information. A permanent record of flow curves should be placed in the worker's medical records. The tests should be conducted by a certified technician and the results interpreted by a physician.

¹ FEF = forced expiratory flow; MEFR = maximal expiratory flow rate; MVV = maximal voluntary ventilation; FRC = functional residual capacity; RV = residual volume; TLC = total lung capacity.

- **Electrocardiogram (EKG).** At least one standard, 12-lead resting EKG should be performed at the discretion of the physician. A "stress test" (graded exercise) may be administered at the discretion of the examining physician, particularly where heat stress may occur.

Baseline Monitoring

If there is likelihood of potential onsite exposure to a particular toxicant, specific baseline monitoring should be performed to establish data relating to that toxicant.

Periodic Medical Examinations

Periodic Screening

Periodic medical examinations should be developed and used in conjunction with pre-employment screening examinations. Comparison of sequential medical reports with baseline data is essential to determine biologic trends that may mark early signs of adverse health effects, and thereby facilitate appropriate protective measures.

The frequency and content of examinations will vary, depending on the nature of the work and exposures. Generally, medical examinations have been recommended at least yearly. More frequent examinations may be necessary, depending on the extent of potential or actual exposure, the type of chemicals involved, the duration of the work assignment, and the individual worker's profile. For example, workers participating in the cleanup of a PCB-contaminated building were initially examined monthly for serum PCB levels. Review of the data from the first few months revealed no appreciable evidence of PCB exposure. The frequency of PCB testing was then reduced [4]. Periodic screening exams can include:

- Interval medical history, focusing on changes in health status, illnesses, and possible work-related symptoms. The examining physician should have information about the worker's interval exposure history, including exposure monitoring at the job site, supplemented by worker-reported exposure history and general information on possible exposures at previously worked sites.
- Physical examination.
- Additional medical testing, depending on available exposure information, medical history, and examination results. Testing should be specific for the possible medical effects of the worker's exposure. Multiple testing for a large range of potential exposures is not always useful; it may involve invasive procedures (e.g., tissue biopsy), be expensive, and may produce false-positive results.
 - *Pulmonary function tests* should be administered if the individual uses a respirator, has been or may be exposed to irritating or toxic substances, or if the individual has breathing difficulties, especially when wearing a respirator.
 - *Audiometric tests.* Annual retests are required for personnel subject to high noise exposures (an 8-hour, time-weighted average of 85 dBA² or more), those required to wear hearing protection, or as otherwise indicated.
 - *Vision tests.* Annual retests are recommended to check for vision degradation.
 - *Blood and urine tests* when indicated.

² dBA = decibels on A-weighted scale (29 CFR Part 1910.95).

Sample Periodic Medical Examination

The basic periodic medical examination is the same as the pre-employment screening (see previous section, *Sample Pre-Employment Examination*), modified according to current conditions, such as changes in the worker's symptoms, site hazards, or exposures.

Termination Examination

At the end of employment at a hazardous waste site, all personnel should have a medical examination as described in the previous sections (see *Sample Pre-Employment Examination*). This examination may be limited to obtaining an interval medical history of the period since the last full examination (consisting of medical history, physical examination, and laboratory tests) if all three following conditions are met:

- The last full medical examination was within the last 6 months.
- No exposure occurred since the last examination.
- No symptoms associated with exposure occurred since the last examination.

If any of these criteria are not met, a full examination is medically necessary at the termination of employment.

Emergency Treatment

Provisions for emergency treatment and acute non-emergency treatment should be made at each site. Preplanning is vital.

When developing plans, procedures, and equipment lists, the range of actual and potential hazards specific to the site should be considered, including chemical, physical (such as heat and/or cold stress, falls and trips), and biologic hazards (animal bites and plant poisoning as well as hazardous biological wastes). Not only site workers, but also contractors, visitors, and other personnel (particularly firefighters) may require emergency treatment.

Emergency medical treatment should be integrated with the overall site emergency response program (see Chapter 12). The following are recommended guidelines for establishing an emergency treatment program.

- Train a team of site personnel in emergency first aid. This should include a Red Cross or equivalent certified course in cardiopulmonary resuscitation (CPR), and first-aid training that emphasizes treatment for explosion and burn injuries, heat stress, and acute chemical toxicity. In addition, this team should include an emergency medical technician (EMT) if possible. Table 5-4 lists signs and symptoms of exposure and heat stress that indicate potential medical emergencies.
- Train personnel in emergency decontamination procedures in coordination with the Emergency Response Plan (see Chapter 12 for details).
- Pre-designate roles and responsibilities to be assumed by personnel in an emergency.
- Establish an emergency/first-aid station on site, capable of providing (1) stabilization for patients requiring offsite treatment, and (2) general first aid (e.g., minor cuts, sprains, abrasions).
 - Locate the station in the clean area adjacent to the decontamination area to facilitate emergency decontamination.
 - Provide a standard first-aid kit or equivalent supplies, plus additional items such as emergency/deluge showers, stretchers, portable water, ice, emergency eyewash, decontamination solutions, and fire-extinguishing blankets.
 - Restock supplies and equipment immediately after each use and check them regularly.

- Arrange for a physician who can be paged on a 24-hour basis.
- Set up an on-call team of medical specialists for emergency consultations, e.g., a toxicologist, dermatologist, hematologist, allergist, ophthalmologist, cardiologist, and neurologist.
- Establish a protocol for monitoring heat stress (see Monitoring section of Chapter 8).
- Make plans in advance for emergency transportation to, treatment at, and contamination control procedures for a nearby medical facility.
 - Educate local emergency transport and hospital personnel about possible medical problems on site; types of hazards and their consequences; potential for exposure; scope and function of the site medical program.
 - Assist the hospital in developing procedures for site-related emergencies. This will help to protect hospital personnel and patients, and to minimize delays due to concerns about hospital safety or contamination.
 - For specific illnesses or injuries, provide details of the incident and the worker's past medical history to the appropriate hospital staff. This is especially crucial when specific medical treatment is required, e.g., for exposure to cyanide or organophosphate pesticides.

Depending on the site's location and potential hazards, it may be important to identify additional medical facilities capable of sophisticated response to chemical or other exposures.

- Post conspicuously (with duplicates near the telephones) the names, phone numbers, addresses, and procedures for contacting:
 - On-call physicians.
 - Medical specialists.
 - Ambulance services.
 - Medical facility(ies).
 - Emergency, fire, and police services.
 - Poison control hotline.
- Provide maps and directions.
- Make sure at least all managers and all individuals involved in medical response know the way to the nearest emergency medical facility.
- Establish a radio communication system for emergency use.
- Review emergency procedures daily with all site personnel at safety meetings before beginning the work shift.

Table 5-4. Signs and Symptoms of Chemical Exposure and Heat Stress that Indicate Potential Medical Emergencies

| TYPE OF HAZARD | SIGNS AND SYMPTOMS |
|------------------------|--|
| Chemical Hazard | Behavioral changes Breathing difficulties Changes in complexion or skin color Coordination difficulties Coughing Dizziness Drooling Diarrhea Fatigue and/or weakness Irritability Irritation of eyes, nose, respiratory tract, skin, or throat |

| TYPE OF HAZARD | SIGNS AND SYMPTOMS |
|--------------------------------------|---|
| Chemical Hazard (cont.) | Headache Light-headedness Nausea Sneezing Sweating Tearing Tightness in the chest |
| Heat Exhaustion | Clammy skin Confusion Dizziness Fainting Fatigue Heat rash Light-headedness Nausea Profuse sweating Slurred speech Weak pulse |
| Heat Stroke (may be fatal) | Confusion Convulsions Hot skin, high temperature (yet may feel chilled) Incoherent speech Convulsions Staggering gait Sweating stops (yet residual sweat may be present) Unconsciousness |

Non-Emergency Treatment

- Arrangements should be made for non-emergency medical care for hazardous waste site workers who are experiencing health effects resulting from an exposure to hazardous substances. In conjunction with the medical surveillance program, offsite medical care should ensure that any potential job-related symptoms or illnesses are evaluated in the context of the worker's exposure. Offsite medical personnel should also investigate and treat non-job-related illnesses that may put the worker at risk because of task requirements (e.g., a bad cold or flu that might interfere with respirator use). A copy of the worker's medical records should be kept at the site (with provisions for security and confidentiality) and, when appropriate, at a nearby hospital. Treating physicians should have access to these records.

Medical Records

Proper record-keeping is essential at hazardous waste sites because of the nature of the work and risks: employees may work at a large number of geographically separate sites during their careers, and adverse effects of long-term exposure may not become apparent for many years. Records enable subsequent medical care providers to be informed about workers' previous and current exposures.

Occupational Safety and Health Administration (OSHA) regulations mandate that, unless a specific occupational safety and health standard provides a different time period, the employer must:

- Maintain and preserve medical records on exposed workers for 30 years after they leave employment (29 CFR Part 1910.20).
- Make available to workers, their authorized representatives, and authorized OSHA representatives the results of medical testing and full medical records and analyses (29 CFR Part 1910.20).
- Maintain records of occupational injuries and illnesses and post a yearly summary report (29 CFR Part 1904).

Program Review

Regular evaluation of the medical program is important to ensure its effectiveness. Maintenance and review of medical records and test results aid medical personnel, site officers, and the parent company and/or agency managers in assessing the effectiveness of the health and safety program. The Site Safety Officer, medical consultant, and/or management representative should, at least annually:

- Ascertain that each accident or illness was promptly investigated to determine the cause and make necessary changes in health and safety procedures.
- Evaluate the efficacy of specific medical testing in the context of potential site exposures.
- Add or delete medical tests as suggested by current industrial hygiene and environmental data.
- Review potential exposures and Site Safety Plans at all sites to determine if additional testing is required.
- Review emergency treatment procedures and update lists of emergency contacts.

References

1. Proficiency Testing Programs:
Division of Technology Evaluation and
Assistance Laboratory Program Office
Center for Disease Control, Atlanta, GA 30333

College of American Pathologists
7400 N. Skokie Blvd., Skokie, IL 60077
American Association for Bioanalysts
205 W. Levee Street, Brownsville, TX 78520
2. Costello, R.J. 1983. U.S. Environmental Protection Agency Triangle Chemical Site, Bridge City, Texas. NIOSH Health Hazard Evaluations Determination Report, HETA 83-417-1357.
3. ANSI. 1984. American National Standard for Respiratory Protection. ANSI Z88.64984. American National Standards Institute, 1430 Broadway, New York, NY 10018.
4. Gleit, A.; Cohen, A.G.; Chase, K.H.; and J. Toth. 1985. Summary Report of the Medical Surveillance Program for the Binghamton State Office Building Decontamination Project. Prepared for Versar New York, Inc.

6. Site Characterization

Contents

| | |
|--|------|
| Introduction | 6-1 |
| Offsite Characterization | 6-2 |
| Interview/Records Research | 6-2 |
| Perimeter Reconnaissance | 6-3 |
| Protection of Entry Personnel | 6-4 |
| Onsite Survey | 6-4 |
| Information Documentation | 6-7 |
| Hazard Assessment | 6-9 |
| Threshold Limit Value (TLV) | 6-9 |
| Permissible Exposure Limit (PEL) | 6-9 |
| Recommended Exposure Limit (REL) | 6-10 |
| IDLH Concentrations | 6-11 |
| Potential Skin Absorption and Irritation | 6-12 |
| Potential Eye Irritation | 6-12 |
| Explosion and Flammability Ranges | 6-12 |
| Hazardous Substance Information Form | 6-13 |
| Monitoring | 6-13 |
| References | 6-13 |

Introduction

Site characterization provides the information needed to identify site hazards and to select worker protection methods. The more accurate, detailed, and comprehensive the information available about a site, the more the protective measures can be tailored to the actual hazards that workers may encounter.

The person with primary responsibility for site characterization and assessment is the Project Team Leader. In addition, outside experts, such as chemists, health physicists, industrial hygienists, and toxicologists, may be needed to accurately and fully interpret all the available information on site conditions.

Site characterization generally proceeds in three phases:

- Prior to site entry, conduct offsite characterization: gather information away from the site and conduct reconnaissance from the site perimeter.
- Next, conduct onsite surveys. During this phase, restrict site entry to reconnaissance personnel.
- Once the site has been determined safe for commencement of other activities, perform ongoing monitoring to provide a continuous source of information about site conditions.

It is important to recognize that site characterization is a continuous process. At each phase of site characterization, information should be obtained and evaluated to define the hazards that the site may pose. This assessment can then be used to develop a safety and health plan for the next phase of work. In addition to the formal information gathering that takes place during the phases of site characterization described here, all site personnel should be constantly alert for new information about site conditions.

The sections below detail the three phases of site characterization and provide a general guide which should be adapted to meet the specific situation. Within each phase of information gathering, the most appropriate sequence of steps should be determined, particularly if there are time or budget considerations that limit the scope of the work. Wherever possible, all information sources should be pursued.

Offsite Characterization

As much information as possible should be obtained *before* site entry so that the hazards can be evaluated and preliminary controls instituted to protect initial entry personnel. Initial information-gathering missions should focus on identifying all potential or suspected conditions that may pose inhalation hazards that are immediately dangerous to life or health (IDLH)¹ or other conditions that may cause death or serious harm (see Table 6-1).

Offsite information can be obtained by two methods: interview/records research and perimeter reconnaissance.

Table 6-1. Visible Indicators of Potential IDLH and Other Dangerous Conditions

- Large containers or tanks that must be entered.
- Enclosed spaces such as buildings or trenches that must be entered.
- Potentially explosive or flammable situations (indicated by bulging drums, effervescence, gas generation, or instrument readings).
- Extremely hazardous materials (such as cyanide, phosgene, or radiation sources).
- Visible vapor clouds.
- Areas where biological indicators (such as dead animals or vegetation) are located.

Interview/Records Research

As much data as possible should be collected before any personnel go on site. Where possible, the following information should be obtained:

- Exact location of the site
- Detailed description of the activity that occurred at the site.
- Duration of the activity.
- Meteorologic data, e.g., current weather and forecast, prevailing wind direction, precipitation levels, temperature profiles.
- Terrain, e.g., historical and current site maps, site photographs, aerial photographs, U.S. Geological Survey topographic quadrangle maps, land use maps, and land cover maps.
- Geologic and hydrologic data.
- Habitation-population centers, population at risk.
- Accessibility by air and roads.
- Pathways of dispersion.
- Present status of response and who has responded.
- Hazardous substances involved and their chemical and physical properties. Information sources Include:

¹ IDLH conditions refer to inhalation hazards (see section on *IDLH Concentrations* later in this chapter).

- Company records, receipts, logbooks, or ledgers.
- Records from state and federal pollution control regulatory and enforcement agencies, state Attorney General's office, state occupational safety and health agencies, state Fire Marshal's office.
- Waste storage inventories and manifests or shipping papers.
- Interviews with personnel and their families (all interview information should be verified). Generator and transporter records.
- Water department and sewage district records. Interviews with nearby residents (note possible site-related medical problems and verify all information from interviews).
- Local fire and police department records. Court records.
- Utility company records.
- Media reports (verify all information from the media).
- Previous surveying (including soil, ground-penetrating radar, and magnetometer surveys), sampling, and monitoring data.

Perimeter Reconnaissance

At a site in which the hazards are largely unknown or there is no need to go on site immediately, visual observations should be made, atmospheric concentrations of airborne pollutants at the site perimeter should be monitored (see Chapter 7, *Air Monitoring*), and samples should be collected near the site. While these data are not definitive indicators of onsite conditions, they can assist in the preliminary evaluation. Perimeter reconnaissance of a site should involve the following actions:

- Develop a preliminary site map, with the locations of buildings, containers, impoundments, pits, ponds, and tanks.
- Review historical and current aerial photographs. Note:
 - Disappearance of natural depressions, quarries, or pits.
 - Variation in reforestation of disturbed areas.
 - Mounding or uplift in disturbed areas or paved surfaces, or modifications in grade.
 - Changes in vegetation around buildings.
 - Changes in traffic patterns at the site.
 - Note any labels, markings, or placards on containers or vehicles.
 - Note the amount of deterioration or damage of containers or vehicles.
 - Note any biologic indicators, such as dead animals or plants.
 - Note any unusual conditions, such as clouds, discolored liquids, oil slicks, vapors, or other suspicious substances.
- Monitor the ambient air at the site perimeter (see Chapter 7, *Air Monitoring*) for:
 - Toxic substances.
 - Combustible and flammable gases or vapors.
 - Oxygen deficiency.
 - Ionizing radiation.
 - Specific materials, if known.
- Note any unusual odors.
- Collect and analyze offsite samples (see reference III for methods) including:
 - Soil.
 - Drinking water.
 - Ground water.
 - Site run-off.
 - Surface water.

Protection of Entry Personnel

The information from interview/records research and perimeter reconnaissance is used as the basis for selecting the protective equipment for the initial site survey. In addition, the proposed work to be accomplished must be considered. For example, if the purpose of the survey is to inspect onsite conditions, count containers, measure the ambient air for "hot spots" (i.e., areas with high concentrations of toxic chemicals), and generally become familiar with the site, the level of protection may be less stringent than if containers are to be opened and samples taken. (Chapter 8, *Personal Protective Equipment*, provides more detail on the selection of protective items.)

The ensemble of clothing and equipment referred to as Level B protection is generally the minimum level recommended for an initial entry until the site hazards have been further identified and the most appropriate protective clothing and equipment chosen. Level B equipment is described in Table 8-7, Chapter 8.

Onsite Survey

The purpose of an onsite survey is to verify and supplement information from the offsite characterization. Prior to going on site, the offsite characterization should be used to develop a Site Safety Plan for site entry that addresses the work to be accomplished and prescribes the procedures to protect the health and safety of the entry team. Priorities should be established for hazard assessment and site activities after careful evaluation of probable conditions. Because team members may be entering a largely unknown environment, caution and conservative actions are appropriate. The composition of the entry team depends on the site characteristics but should always consist of at least four persons: two workers who will enter the site and two outside support persons, suited in personal protective equipment and prepared to enter the site in case of emergency. Upon entering the site, entry personnel should:

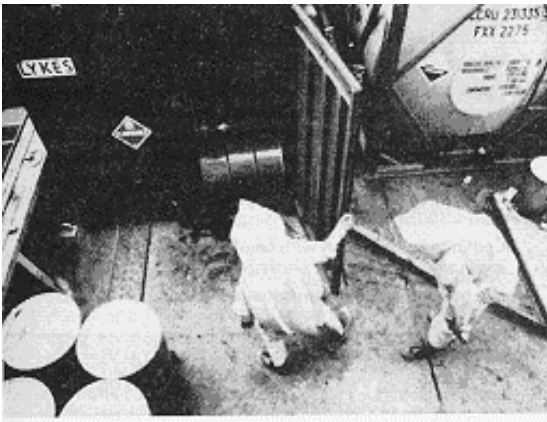

As part of site characterization, workers suited in Level A protective ensembles work in pairs when investigating confined spaces.

- Monitor the air for IDLH and other conditions that may cause death or serious harm (combustible or explosive atmospheres, oxygen deficiency, toxic substances). Chapter 7 provides detailed information on air monitoring.
- Monitor for ionizing radiation. Survey for gamma and beta radiation with a Geiger-Mueller detection tube or a gamma scintillation tube; if alpha radiation is expected, use a proportional counter.
- Visually observe for signs of actual or potential IDLH or other dangerous conditions (see Table 6-1).

Any indication of IDLH hazards or other dangerous conditions should be regarded as a sign to proceed with care and deliberation. Extreme caution should be exercised in continuing the site survey when such hazards are indicated. Table 6-2 provides some basic guidelines for decision-

making. If IDLH or other dangerous conditions are not present, or if proper precautions can be taken, continue the survey:

- Conduct further air monitoring as necessary (see Chapter 7).
- Note the types of containers, impoundments, or other storage systems:
 - Paper or wood packages.
 - Metal or plastic barrels or drums.
 - Underground tanks.
 - Aboveground tanks.
 - Compressed gas cylinders.
 - Pits, ponds, or lagoons.
 - Other.
- Note the condition of waste containers and storage systems:
 - Sound (undamaged).
 - Visibly rusted or corroded.
 - Leaking.
 - Bulging.
 - Types and quantities of material in containers.
 - Labels on containers indicating corrosive explosive, flammable, radioactive or toxic materials.
- Note the physical condition of the materials:
 - Gas, liquid, or solid.
 - Color and turbidity.
 - Behavior, e.g., corroding, foaming or vaporizing.
 - Conditions conducive to splash or contact.
- Identify natural wind barriers:
 - Buildings.
 - Hills.
 - Tanks.
- Determine the potential pathways of dispersion:
 - Air.
 - Biologic routes, such as animals and food chains.
 - Ground water.
 - Land surface.
 - Surface water.
- If necessary, use one or more of the following remote sensing or subsurface investigative methods to locate buried wastes or contaminant plumes:
 - Electromagnetic resistivity.
 - Seismic refraction.
 - Magnetometry.
 - Metal detection.
 - Ground-penetrating radar.
- Note any indicators of potential exposure to hazardous substances:
 - Dead fish, animals or vegetation.

- Dust or spray in the air.
- Fissures or cracks in solid surfaces that expose deep waste layers.
- Pools of liquid.
- Foams or oils on liquid surfaces.
- Gas generation or effervescence.
- Deteriorating containers.
- Cleared land areas or possible landfilled areas.
- Note any safety hazards. Consider:
 - Conditions of site structures.
 - Obstacles to entry and exit.
 - Terrain homogeneity.
 - Terrain stability.
 - Stability of stacked material.
- Identify any reactive, incompatible, flammable, or highly corrosive wastes.
- Note land features.
- Note the presence of any potential naturally occurring skin irritants or dermatitis-inducing agents, for example:
 - Poison ivy.
 - Poison oak.
 - Poison sumac.
- Note any tags, labels, markings, or other identifying indicators.
- Collect samples [1]:
 - Air (see Chapter 7, *Air Monitoring*).
 - Drainage ditches.
 - Soil (surface and subsurface).
 - Standing pools of liquids.
 - Storage containers.
 - Streams and ponds.
 - Ground water (upgradient, beneath site, downgradient).
- Sample for or otherwise identify:
 - Biologic or pathologic hazards.
 - Radiologic hazards.

Table 6-2. Guidelines for Some Atmospheric Hazards^a

| HAZARD ^b | MONITORING EQUIPMENT ^c | MEASURED LEVEL | ACTION |
|-----------------------------|-----------------------------------|--|--|
| Explosive atmosphere | Combustible gas indicator | <10% LEL ^d 10%-25% LEL >25% LEL | Continue investigation. Continue onsite monitoring with extreme caution as higher levels are encountered. Explosion hazard. Withdraw from area immediately. |
| Oxygen | Oxygen concentration meter | <19.5% 19.5%-25% >25% | Monitor wearing self-contained breathing apparatus. NOTE: Combustible gas readings are not valid in atmospheres with <19.5% oxygen. Continue investigation with caution. Deviation |

| HAZARD ^b | MONITORING EQUIPMENT ^c | MEASURED LEVEL | ACTION |
|---|--|---|--|
| Oxygen (cont.) | | | from normal level may be due to the presence of other substances. Fire hazard potential. Discontinue investigation. Consult a fire safety specialist. |
| Radiation | Radiation survey equipment | ≤2 mrem/hr ^{e,f} >2 mrem/hr | Radiation above background levels (normally 0.01-0.02 mrem/hr) ^g signifies the possible presence of radiation sources. Continue investigation with caution. Perform thorough monitoring. Consult with a health physicist. Potential radiation hazard. Evacuate site. Continue investigation only upon the advice of a health physicist. |
| Inorganic and organic gases and vapors | Colorimetric tubes Chemical-specific instruments, including halide meter, hydrogen sulfide detector, carbon monoxide monitor, and mercury meter | Depends on chemical | Consult standard reference manuals for air concentration/toxicity data. Action level depends on PEL/REL/TLV. ^h |
| Organic gases and vapors | Portable photoionizer Organic vapor analyzer (1) Operated in gas chromatography (GC) mode (2) Operated in survey mode | Depends on chemical | Consult standard reference manuals for air concentration/toxicity data. Action level depends on PEL/REL/TLV. ^h |

^aBased on *Standard Operating Guides*. U.S. EPA. December, 1984.

^bThese are general classes of hazards. Not all components of these classes can be measured.

^cConsult manufacturers' literature for use limitations associated with the specific equipment and for the specific substances the equipment can detect. See Tables 7-1 and 7-2 for more complete descriptions.

^dLEL = lower explosive limit.

^emrem/hr = milliroentgen equivalent in man per hour

^fSource: U.S. Nuclear Regulatory Commission Rules and Regulations, 10 CFR Chapter 1, Part 20.105.

^gSource: Sax, I.N. 1979. *Dangerous Properties of Industrial Materials*. Fifth Edition. p. 167. Van Nostrand Reinhold Company, New York.

^h PEL = OSHA permissible exposure limit.

REL = NIOSH recommended exposure limit.

TLV = threshold limit value.

See Table 6-4.

Information Documentation

Proper documentation and document control are important for ensuring accurate communication; ensuring the quality of the data collected; providing the rationale for safety decisions; and substantiating possible legal actions. Documentation can be accomplished by recording information pertinent to field activities, sample analysis, and site conditions in one of several ways, including:

- Logbooks.
- Field data records.
- Graphs.
- Photographs.
- Sample labels.
- Chain-of-custody forms.

- Analytical records.

These documents should be controlled to ensure that they are all accounted for when the project is completed. The task of document control should be assigned to one individual on the project team and should include the following responsibilities:

- Numbering each document (including sample labels) with a unique number.
- Listing each document in a document inventory.
- Recording the whereabouts of each document in a separate document register so that any document can be readily located. In particular, the name and location of site personnel that have documents in their possession should be recorded.
- Collecting all documents at the end of each work period.
- Making sure that all document entries are made in waterproof ink.
- Filing all documents in a central file at the completion of the site response.

Field personnel should record all onsite activities and observations in a field logbook—a bound book with consecutively numbered pages. Entries should be made during or just after completing a task to ensure thoroughness and accuracy. Table 6-3 shows the level of detail that should be recorded during sampling.

Photographs can be an accurate, objective addition to a field worker's written observations. For each photograph taken, the following information should be recorded in the field logbook:

- Date, time, and name of site.
- Name of the photographer.
- Location of the subject within the site.
- General compass direction of the orientation of the photograph.
- General description of the subject.
- Sequential number of the photograph and the film roll number.
- Camera, lens, and film type used for photography.

Table 6-3. Example of Field Logbook Entries to Describe Sampling

- Date and time of entry.
- Purpose of sampling.
- Name, address, and affiliation of personnel performing sampling.
- Name and address of the material's producer, if known.
- Type of material, e.g., sludge or wastewater.
- Description of material container.
- Description of sample.
- Chemical components and concentrations, if known.
- Number and size of samples taken.
- Description and location of the sampling point.
- Date and time of sample collection.
- Difficulties experienced in obtaining sample (e.g., is it representative of the bulk material?).
- Visual references, such as maps or photographs of the sampling site.
- Field observations, such as weather conditions during sampling periods.
- Field measurements of the materials, e.g., explosiveness, flammability, or Ph.
- Whether chain-of-custody forms have been filled out for the samples.

Serially numbered sample labels or tags should be assigned to sampling team personnel and recorded in the field logbook. Lost, voided, or damaged labels should be noted in the logbook. Labels should be firmly affixed to the sample containers using either gummed labels or tags attached by string or wire. Information should be recorded on the tag in waterproof ink and should include items such as:

- The unique sample log number.
- Date and time that the sample was collected.
- Source of the sample, e.g., name, location, and type of sample.
- Preservative used.
- Analysis required.
- Name of collector.
- Pertinent field data.

In addition to supporting litigation, written records of sample collection, transfer, storage, analysis, and destruction help ensure the proper interpretation of analytical test results. Information describing the chain of custody should be recorded on a form that accompanies the sample from collection to destruction.



Sample jars are labeled prior to sampling as part of site documentation procedures.

Hazard Assessment

Once the presence and concentrations of specific chemicals or classes of chemicals have been established, the hazards associated with these chemicals must be determined. This is done by referring to standard reference sources for data and guidelines on permissible levels of exposure, flammability, etc. Some key guidelines are listed in Table 6-4 and are described below.

Threshold Limit Value (TLV)[®]

TLVs can be used as a guideline for determining the appropriate level of worker protection. These values have been derived for many substances and can be found in *Threshold Limit Values for Chemical Substances and Physical Agents*, which is published annually by the American Conference of Governmental Industrial Hygienists (ACGIH) 121. The ACGIH defines three categories of TLVs: time-weighted average (TWA); short-term exposure limit (STEL); and ceiling (C). All three categories may be useful in selecting levels of protection at a hazardous waste site. Refer to the *Threshold Limit Values for Chemical Substances and Physical Agents* [2] for additional details.

Permissible Exposure Limit (PEL)

Permissible exposure limits are enforceable standards promulgated by OSHA. In many cases they are derived from TLVs published in 1968. The PEL for a substance is the 8-hour time-weighted average or ceiling concentration above which workers may not be exposed. Although

personal protective equipment may not be required for exposures below the PEL, its use may be advisable where there is a potential for overexposure. See the tables and substance-specific standards in 29 CFR Part 1910, Subpart Z, for additional details.

Recommended Exposure Limit (REL)

A NIOSH recommended exposure limit (REL) is the workplace exposure concentration recommended by NIOSH for promulgation by OSHA as a PEL, but is not enforceable as is the OSHA PEL. In some cases, NIOSH has described time-weighted average concentrations in terms of 10-hour, rather than 8-hour, averages.

Table 6-4. Guidelines for Assessing Chemical and Physical Hazards

| HAZARD | GUIDELINE | | EXPLANATION | SOURCES FOR VALUES ^a |
|--|-------------|---|---|---------------------------------|
| Inhalation of airborne contaminants | TLV | Threshold Limit Value | One of three categories of chemical exposure levels, defined as follows: | |
| | TLV-TWA | Threshold Limit Value-Time-Weighted Average | The time-weighted average concentration for a normal 8-hour workday and a 40-hour work week, to which nearly all workers may be repeatedly exposed without adverse effect. Should be used as an exposure guide rather than an absolute threshold. | ACGIH |
| | TLV-STEL | Threshold Limit Value-Short-Term Exposure Limit | A 15-minute time-weighted average exposure that should not be exceeded at any time during the work day. | ACGIH |
| | TLV-C | Threshold Limit Value-Ceiling | The concentration that should not be exceeded even instantaneously. | ACGIH |
| | PEL | Permissible Exposure Limit | Time-weighted average and ceiling concentrations similar to (and in many cases derived from) the threshold limit values published in 1968. | OSHA |
| | REL | Recommended Exposure Limit | Time-weighted averages and ceiling concentrations based on NIOSH evaluations. | NIOSH |
| | IDLH | Immediately Dangerous to Life or Health | The maximum level from which a worker could escape without any escape-impairing symptoms or any irreversible health effects. | NIOSH |
| Dermal absorption of chemicals through airborne or direct contact Dermal irritation | Designation | "skin" | The designation "skin" in the ACGIH, OSHA, and NIOSH references ^a indicates that a substance may be readily absorbed through the intact skin; however, it is not a threshold for safe exposure. Direct contact with a substance designated "skin" should be avoided. Many substances irritate skin. Consult standard references | ACGIH/ OSHA/ NIOSH |
| Carcinogens | TLV | Threshold Limit Value | Some carcinogens have an assigned TLV. | ACGIH |
| | PEL | Permissible Exposure Limit | OSHA has individual standards for some specific carcinogens. | OSHA |
| | REL | Recommended Exposure Limit | NIOSH makes recommendations regarding exposures to carcinogens. | NIOSH |

| HAZARD | GUIDELINE | EXPLANATION | SOURCES FOR VALUES ^a | |
|---------------------------|--|----------------------------|--|-------|
| Noise | TLV | Threshold Limit Value | Sound pressure levels and durations of exposure that represent conditions to which it is believed that nearly all workers may be repeatedly exposed without an adverse effect on their ability to hear and understand normal speech. | ACGIH |
| | PEL | Permissible Exposure Limit | .Limits for acceptable noise exposure. | OSHA |
| | REL | Recommended Exposure Limit | Limits for acceptable noise exposure. | NIOSH |
| Ionizing Radiation | Maximum permissible body burden and maximum permissible concentrations of radionuclides in air and in water. | | | NCRP |
| | PEL | Permissible Exposure Limit | Dose in rems per calendar quarter. | OSHA |
| Explosion | LEL | Lower Explosive Limit | The minimum concentration of vapor in air below which propagation of a flame will not occur in the presence of an ignition source. | NFPA |
| | UEL | Upper Explosive Limit | The maximum concentration of a vapor in air above which propagation of a flame will not occur in the presence of an ignition source. | NFPA |
| Fire | Flash Point | | The lowest temperature at which the vapor of a combustible liquid can be made to ignite momentarily in air. | NFPA |

^aSources:

ACGIH. 1984-85. Threshold Limit Values for Chemical Substances and Physical Agents in the Workplace Environment and Biological Exposure Indices with Intended Changes for 1985-86. American Conference of Governmental Industrial Hygienists, Cincinnati, Ohio.

NIOSH. Centers for Disease Control. 1983. NIOSH Recommendations for Occupational Health Standards. Morbidity and Mortality Weekly Report Supplement. Vol. 32, No. 1S, October 7, 1983.

NIOSH. 1985. Pocket Guide to Chemical Hazards. National Institute for Occupational Safety and Health, Cincinnati, Ohio.

NCRP. Basic Radiation Protection Criteria. NCRP Report No. 39. National Council on Radiation Protection and Measurements, Washington, D.C.

NCRP. Maximum Permissible Body Burdens and Maximum Permissible Concentrations of Radionuclides in Air and Water for Occupational Exposure. NCRP Report No. 22. National Council on Radiation Protection and Measurements, Washington, D.C.

NFPA. 1985. Fire Protection Guide on Hazardous Materials. Eighth Edition. National Fire Protection Association, Boston, Massachusetts.

OSHA. 29 CFR Part 1910. (OSHA standards are legally binding.)

^bOther sources have slightly different definitions of IDLH (see IDLH Concentrations in this chapter).

IDLH Concentrations

IDLH exposure concentrations have been established by the NIOSH/OSHA Standards Completion Program (SCP) as a guideline for selecting respirators for some chemicals. The definition of IDLH varies depending on the source. For example, the Mine Safety and Health Administration Standard (30 CFR Part 11.3(t)) defines IDLH conditions as those that pose an immediate threat to life or health or that pose an immediate threat of severe exposure to contaminants such as radioactive materials that are likely to have adverse cumulative or delayed effects on health. The NIOSH *Pocket Guide to Chemical Hazards* [3] defines IDLH concentration as the "... maximum level from which one could escape within 30 minutes without any escape-impairing symptoms or any irreversible health effects....." The American National Standards Institute, Inc. (ANSI) defines IDLH as "...any atmosphere that poses an immediate hazard to life

or produces immediate irreversible debilitating effects on health ..." [4]. Regardless of their exact definition, all IDLH values indicate those concentrations of toxic substances from which escape is possible without irreversible harm should a worker's respiratory protective equipment fail. At hazardous waste sites, IDLH concentrations should be assumed to represent concentrations above which only workers wearing respirators that provide the maximum protection (i.e., a positive-pressure, full-facepiece, self-contained breathing apparatus [SCBA] or a combination positive-pressure, full-facepiece, supplied-air respirator with positive-pressure SCBA [see Chapter 8) are permitted. Specific IDLH values for many substances can be found in the NIOSH *Pocket Guide to Chemical Hazards* [3].

Potential Skin Absorption and Irritation

Information on skin absorption is provided in the ACGIH publication, *Threshold Limit Values for Chemical Substances and Physical Agents* [2] and in OSHA standard 29 CFR Part 1910.1000 and other standard references. These documents identify substances that can be readily absorbed through the skin, mucous membranes, and/or eyes by either airborne exposure or direct contact with a liquid. This information, like most available information on skin absorption is qualitative. It indicates whether, but not to what extent, a substance may pose a dermal hazard. Thus decisions made concerning skin hazards are necessarily judgmental.

In addition, many chemicals, although not absorbed through the skin, may cause skin irritation at the point of contact. Signs of skin irritation range from redness, swelling, or itching to burns that destroy skin tissue. Standard references can be used to determine whether a chemical may act as an irritant.

Potential Eye Irritation

Quantitative data on eye irritation are not always available. Where a review of the literature indicates that a substance causes eye irritation, but no threshold is specified, have a competent health professional evaluate the data to determine the level of personal protection needed for onsite workers.

Explosion and Flammability Ranges

The lower explosive limit (LEL) or lower flammable limit (LFL) of a substance is the minimum concentration of gas or vapor in air below which the substance will not burn when exposed to a source of ignition. This concentration is usually expressed in percent by volume. Below this concentration, the mixture is too "lean" to burn or explode.

The upper explosive limit (UEL) or upper flammable limit (UFL) of a substance is the maximum concentration of gas or vapor above which the substance will not burn when exposed to a source of ignition. Above this concentration, the mixture is too "rich" to burn or explode.

The flammable range is the range of concentrations between the LFL and UFL where the gas-air mixture will support combustion'.

The flashpoint of a substance is the minimum temperature at which it gives off sufficient vapor to form an ignitable mixture with the air just above the surface of the substance. Ignition of a substance at the flashpoint is not continuous.

The ignition temperature or autoignition temperature is the minimum temperature required to initiate or cause self-sustained combustion without an ignition source.

When evaluating the fire or explosion potential at a hazardous waste site, all equipment used should be intrinsically safe or explosion-proof. Where flammable or explosive atmospheres are detected, ventilation may dilute the mixture to below the LEL/LFL. However, ventilation is generally not recommended if concentrations exceed the UFL/UEL, since the mixture will pass through the flammable/explosive range as it is diluted. Note that combustible gas indicator readings may not be accurate when oxygen concentrations are less than 19.5 percent.

Hazardous Substance Information Form

Information on the chemical, physical, and toxicologic properties of each compound known or expected to occur on site should be recorded on a Hazardous Substance Information Form (see Appendix C). Response personnel will then have the necessary health and safety information in one place, and new personnel can be quickly briefed. As many reference sources as possible should be used to fill out the sheets because the information may vary from one source to another. Material Safety Data Sheets provided by chemical manufacturers are one source for this information.

Monitoring

Because site activities and weather conditions change, an ongoing air monitoring program should be implemented after characterization has determined that the site is safe for the commencement of operations.

The ongoing monitoring of atmospheric chemical hazards should be conducted using a combination of stationary sampling equipment, personnel monitoring devices, and periodic area monitoring with direct-reading instruments (see Chapter 7, *Air Monitoring*).

Data obtained during offsite and onsite surveys can be used to develop a plan that details the procedures to be used for monitoring ambient conditions during cleanup operations. Where necessary, routes of exposure other than inhalation should be monitored. For example, skin swipe tests may be used to determine the effectiveness of personal protective clothing (see Chapter 10, *Decontamination*). Depending on the physical properties and toxicity of the onsite materials, community exposures resulting from hazardous waste site operations may need to be assessed [5].

Monitoring also includes continual evaluation of any changes in site conditions or work activities that could affect worker safety. When a significant change occurs, the hazards should be reassessed. Some indicators of the need for reassessment are:

- Commencement of a new work phase, such as the start of drum sampling.
- Change in job tasks during a work phase.
- Change of season.
- Change in weather.
- Change in ambient levels of contaminants.

References

1. U.S. EPA. 1984. Characterization of Hazardous Waste Sites-A Methods Manual: Volume II. Available Sampling Methods. Second edition. EPA 600/4-84-076.

2. ACGIH. 1984-85. Threshold Limit Values for Chemical Substances and Physical Agents in the Workplace Environment and Biological Exposure Indices with Intended Changes for 1985-86. American Conference of Governmental Industrial Hygienists, Cincinnati, OH.
3. NIOSH. 1985. Pocket Guide to Chemical Hazards. National Institute for Occupational Safety and Health, Cincinnati, OH.
4. ANSI. 1980. Practices for Respiratory Protection. ANSI Z88.2-1980. American National Standards Institute, 1430 Broadway, New York, NY 10018.
5. U.S. Department of Health and Human Services. 1984. A System for Prevention, Assessment and Control of Exposures and Health Effects from Hazardous Sites (S.P.A.C.E. for Health), U.S. Department of Health and Human Services, Public Health Service, Center for Disease Control, Atlanta, GA.

7. Air Monitoring

Contents

| | |
|---|------|
| Introduction | 7-1 |
| Measuring Instruments | 7-1 |
| Direct-Reading Instruments | 7-2 |
| Laboratory Analysis | 7-7 |
| Site Monitoring | 7-7 |
| Monitoring for IDLH and Other Dangerous Conditions | 7-8 |
| General Onsite Monitoring | 7-9 |
| Perimeter Monitoring | 7-9 |
| Periodic Monitoring | 7-9 |
| Personal Monitoring | 7-9 |
| Variables of Hazardous Waste Site Exposure | 7-10 |
| References | 7-11 |

Introduction

Airborne contaminants can present a significant threat to worker health and safety. Thus, identification and quantification of these contaminants through air monitoring is an essential component of a health and safety program at a hazardous waste site. Reliable measurements of airborne contaminants are useful for:

- Selecting personal protective equipment.
- Delineating areas where protection is needed.
- Assessing the potential health effects of exposure
- Determining the need for specific medical monitoring. This chapter delineates the factors to consider when conducting air monitoring at a hazardous waste site. It presents strategies for assessing airborne contamination at hazardous waste sites and describes instruments and methods for measuring exposures.

Measuring Instruments

The purpose of air monitoring is to identify and quantify airborne contaminants in order to determine the level of worker protection needed. Initial screening for identification is often qualitative, i.e., the contaminant, or the class to which it belongs, is demonstrated to be present but the determination of its concentration (quantification) must await subsequent testing. Two principal approaches are available for identifying and/or quantifying airborne contaminants:

- The onsite use of direct-reading instruments.
- Laboratory analysis of air samples obtained by gas sampling bag, filter, sorbent, or wet-contaminant collection methods.

Direct-Reading Instruments

Direct-reading instruments were developed as early warning devices for use in industrial settings, where a leak or an accident could release a high concentration of a known chemical into the ambient atmosphere. Today, some direct-reading instruments can detect contaminants in concentrations down to one part contaminant per million parts of air (ppm), although quantitative data are difficult to obtain when multiple contaminants are present. Unlike air sampling devices, which are used to collect samples for subsequent analysis in a laboratory, direct reading instruments provide information at the time of sampling, enabling rapid decision-making.

Direct-reading instruments may be used to rapidly detect flammable or explosive atmospheres, oxygen deficiency, certain gases and vapors, and ionizing radiation. They are the primary tools of initial site characterization. The information provided by direct-reading instruments can be used to institute appropriate protective measures (e.g., personal protective equipment, evacuation), to determine the most appropriate equipment for further monitoring, and to develop optimum sampling and analytical protocols.

All direct-reading instruments have inherent constraints in their ability to detect hazards:

- They usually detect and/or measure only specific classes of chemicals.
- Generally, they are not designed to measure and/or detect airborne concentrations below 1 ppm.
- Many of the direct-reading instruments that have been designed to detect one particular substance also detect other substances (interference) and, consequently, may give false readings.

It is imperative that direct-reading instruments be operated, and their data interpreted, by qualified individuals who are thoroughly familiar with the particular device's operating principles and limitations and who have obtained the device's latest operating instructions and calibration curves. At hazardous waste sites, where unknown and multiple contaminants are the rule rather than the exception, instrument readings should be interpreted conservatively. The following guidelines may facilitate accurate recording and interpretation:

- Calibrate instruments according to the manufacturer's instructions before and after every use.
- Develop chemical response curves if these are not provided by the instrument manufacturer.
- Remember that the instrument's readings have limited value where contaminants are unknown. When recording readings of unknown contaminants, report them as "needle deflection" or "positive instrument response" rather than specific concentrations (i.e., ppm). Conduct additional monitoring at any location where a positive response occurs.
- A reading of zero should be reported as "no instrument response" rather than "clean" because quantities of chemicals may be present that are not detectable by the instrument.
- The survey should be repeated with several detection systems to maximize the number of chemicals detected.

Tables 7-1 and 7-2 list several direct-reading instruments and the conditions and/or substances they measure. The flame ionization detector (FID) and the photoionization detector (PID) (see Table 7-1) are commonly used at hazardous waste sites. However, some of these devices may not detect some particularly toxic agents, including hydrogen cyanide and hydrogen sulfide. Thus, these devices must be supplemented with other methods of detection.

Table 7-1. Some Direct-Reading Instruments for General Survey

| INSTRUMENT | HAZARD MONITORED | APPLICATION | DETECTION METHOD | LIMITATIONS | EASE OF OPERATION | GENERAL CARE AND MAINTENANCE | TYPICAL OPERATING TIMES |
|---|--------------------------------|--|--|--|---|---|--|
| Combustible Gas Indicator (CGI) | Combustible gases and vapors. | Measures the concentration of a combustible gas or vapor. | A filament, usually made of platinum, is heated by burning the combustible gas or vapor. The increase in heat is measured. | <p>Accuracy depends, in part, on the difference between the calibration and sampling temperatures.</p> <p>Sensitivity is a function of the differences in the chemical and physical properties between the calibration gas and the gas being sampled.</p> <p>The filament can be damaged by certain compounds such as silicones, halides, tetraethyl lead, and oxygen-enriched atmospheres.</p> <p>Does not provide a valid reading under oxygen-deficient conditions.</p> | Effective use requires that operator understand the operating principles and procedures. | <p>Recharge or replace battery.</p> <p>Calibrate immediately before use.</p> | Can be used for as long as the battery lasts, or for the recommended interval between calibrations, whichever is less. |
| Flame Ionization Detector (FID) with Gas Chromatography Option | Many organic gases and vapors. | In survey mode, detects the total concentration of many organic gases and vapors. In gas chromatography (GC) mode, identifies and measures specific compounds. | Gases and vapors are ionized in a flame. A current is produced in proportion to the number of carbon atoms present. | <p>Does not detect inorganic gases and vapors, or some synthetics. Sensitivity depends on the compound.</p> <p>Should not be used at temperatures less than 40°F (4°C).</p> <p>Difficult to absolutely</p> | <p>Requires experience to interpret data correctly, especially in the GC mode.</p> <p>Specific identification requires calibration with the specific analyte of interest.</p> | <p>Recharge or replace battery.</p> <p>Monitor fuel and/or combustion air supply gauges.</p> <p>Perform routine maintenance as described in the manual.</p> | 8 hours; 3 hours with strip chart recorder. |

| INSTRUMENT | HAZARD MONITORED | APPLICATION | DETECTION METHOD | LIMITATIONS | EASE OF OPERATION | GENERAL CARE AND MAINTENANCE | TYPICAL OPERATING TIMES |
|---|------------------------|--|---|--|--|---|---|
| | | In survey mode, all the organic compounds are ionized and detected at the same time. In GC mode, volatile species are separated. | | <p>identify compounds.</p> <p>High concentrations of contaminants of oxygen-deficient atmospheres require system modification.</p> <p>In survey mode, readings can be only reported relative to the calibration standard used.</p> | | Check for leaks. | |
| Gamma Radiation Survey Instrument | Gamma radiation | Environmental radiation monitor. | Scintillation detector. | Does not measure alpha or beta radiation. | Extremely easy to operate, but requires experience to interpret data. Rugged, good in field use. | Must be calibrated annually at a specialized facility | Can be used for as long as the battery lasts, or for the recommended interval between calibrations whichever is less. |
| Portable Infrared (IR) Spectrophotometer | Many gases and vapors. | <p>Measures concentration of many gases and vapors in air.</p> <p>Designed to quantify one- or two-component mixtures.</p> | Passes different frequencies of IR through the sample. The frequencies adsorbed and specific for each compound. | <p>In the field, must make repeated passes to achieve reliable results.</p> <p>Requires 115-volt AC power.</p> <p>Not approved for use in a potentially flammable or explosive atmosphere.</p> <p>Interference by water vapor and carbon</p> | Requires personnel with extensive experience in IR spectrophotometry. | As specified by manufacturer. | |

| INSTRUMENT | HAZARD MONITORED | APPLICATION | DETECTION METHOD | LIMITATIONS | EASE OF OPERATION | GENERAL CARE AND MAINTENANCE | TYPICAL OPERATING TIMES |
|--|---|--|--|---|---|---|--|
| | | | | <p>dioxide.</p> <p>Certain vapors and high moisture may attach the instruments optics, which must then be replaced.</p> | | | |
| Ultraviolet (UV) Photoionization Detector (PID) | Many organic and some inorganic gases and vapors. | Detects total concentrations of many organic and some inorganic gases and vapors. Some identification of compounds is possible if more than one probe is used. | Ionizes molecules using UV radiation; produces a current that is proportional to the number of ions. | <p>Does not detect methane.</p> <p>Does not detect a compound if the probe used has a lower energy level than the compound's ionization potential.</p> <p>Response may change when gases are mixed.</p> <p>Other voltage sources may interfere with measurements.</p> <p>Readings can only be reported relative to the calibration standard used.</p> <p>Response is affected by high humidity.</p> | Effective use requires that the operator understand the operating principles and procedures, and be competent in calibrating, reading, and interpreting the instrument. | <p>Recharge or replace battery.</p> <p>Regularly clean lamp window.</p> <p>Regularly clean and maintain the instrument and accessories.</p> | 10 hours; 5 hours with strip chart recorder. |

Table 7-2. Some Direct-Reading Instruments for Specific Survey

| INSTRUMENT | HAZARD MONITORED | APPLICATION | DETECTION METHOD | LIMITATIONS | EASE OF OPERATION | GENERAL CARE AND MAINTENANCE | TYPICAL OPERATING TIMES |
|--|----------------------------|---|--|---|--|---|-------------------------|
| Direct-Reading Colorimetric Indicator Tubes | Specific gases and vapors. | Measures concentrations of specific gases and vapors. | The compound reacts with the indicator chemical in the tube, producing a stain whose length or color change is proportional to the compound's concentration. | <p>The measured concentration of the same compound may vary among different manufacturers' tubes. Many similar chemicals interfere.</p> <p>Greatest sources of error are (1) how the operator judges stain's end-point, and (2) the tube's limited accuracy.</p> <p>Affected by humidity.</p> | Minimal operator training and expertise required. | Do not use a previously opened tube even if the indicator chemical is not stained. | |
| Oxygen Meter | Oxygen (O ₂) | Measures the percentage of O ₂ in air. | Uses an electrochemical sensor to measure the partial pressure of O ₂ in the air and converts that reading to O ₂ concentration. | <p>Must be calibrated prior to use to compensate for altitude and barometric pressure.</p> <p>Certain gases, especially oxidants such as ozone, can affect readings. Carbon dioxide (CO₂) poisons the detector cell.</p> | Effective use requires that the operator understand the operating principles and procedures. | <p>Replace detector cell according to manufacturer's recommendations.</p> <p>Recharge or replace batteries prior to expiration of the specified interval.</p> <p>If the ambient air is more than 0.5% CO₂, replace the O₂ detector cell frequently.</p> | 8 to 12 hours. |

Laboratory Analysis

Direct-reading personal monitors are available for only a few specific substances and are rarely sensitive enough to measure the minute (i.e., parts of contaminant per billion parts of air) quantities of contaminants which may, nevertheless induce health changes. Thus to detect relatively low-level concentrations of contaminants, long-term or "full-shift" personal air samples must be analyzed in a laboratory. Full-shift air samples for some chemicals may be collected with passive dosimeters, or by means of a pump which draws air through a filter or sorbent. Table 7-3 lists some sampling and analytical techniques used at hazardous waste sites.

Selection of the appropriate sampling media largely depends on the physical state of the contaminants. For example, chemicals such as PCBs (polychlorinated biphenyls) and PNAs (polynuclear aromatic hydrocarbons) occur as both vapors and particulate-bound contaminants. A dual-media system is needed to measure both forms of these substances. The volatile component is collected on a solid adsorbent and the nonvolatile component is collected on a filter. More than two dozen dual-media sampling techniques have been evaluated by NIOSH [1,2].

A major disadvantage of long-term air monitoring is the time required to obtain data. The time lag between sampling and obtaining the analysis results may be a matter of hours, if an onsite laboratory is available, or days, weeks, even months, if a remote laboratory is involved. This can be significant problem if the situation requires immediate decisions concerning worker safety.

Also, by the time samples are returned from a remote laboratory, the hazardous waste site cleanup may have progressed to a different stage or to a location at which different contaminants or different concentrations may exist. Careful planning and/or the use of a mobile laboratory on site may alleviate these problems.

Mobile laboratories may be brought on site to classify hazardous wastes for disposal. A mobile laboratory is generally a trailer truck that houses analytical instruments capable of rapidly classifying contaminants by a variety of techniques. Typical instruments include gas chromatographs, spectrofluorometers, and infrared spectrophotometers. When not in use in the mobile laboratory, these devices can be relocated to fixed-base facilities. Onsite laboratory facilities and practices should meet standards of good laboratory safety.

Usually, a few of the field samples collected are analyzed on site to provide rapid estimates of the concentration of airborne contaminants. These data can be used to determine the initial level of worker personal protection necessary to modify field sampling procedures and to guide the fixed-base laboratory analysis. If necessary, samples screened in the mobile laboratory can be subsequently reanalyzed in sophisticated fixed-base laboratories. The mobile laboratory also provides storage space, countertop staging areas for industrial hygiene equipment, and facilities for recharging self-contained breathing apparatus.

Site Monitoring

Priorities for air monitoring should be based on the information gathered during initial site characterization (see Chapter 6). This information serves as the basis for selecting the appropriate monitoring equipment and personal protective equipment (PPE) to use when conducting site monitoring. Depending on site conditions and project goals, four categories of site monitoring may be necessary: monitoring for IDLH and other dangerous conditions, general onsite monitoring, perimeter monitoring, and periodic monitoring.

Table 7-3. Some Sample Collection and Analytical Methods

| SUBSTANCE | COLLECTION DEVICE ^a | ANALYTICAL METHOD ^b | TYPICAL DETECTION LIMIT OF ANALYTIC INSTRUMENT (λg) |
|-------------------------|---|--------------------------------|---|
| Anions: | Prewashed silica gel tube | Ion chromatography | |
| Bromide | | | 10 |
| Chloride | | | 5 |
| Fluoride | | | 5 |
| Nitrate | | | 10 |
| Phosphate | | | 20 |
| Sulfate | 10 | | |
| Aliphatic Amines | Silica gel | GC/NPD | 10 |
| Asbestos | MCEF | PCM | 100 ^c |
| Metals | MCEF | ICP-AES | 0.5 |
| Organics | Charcoal tube | GC/MS | 10 |
| Nitrosamines | Thermosorb/N | GC/TEA | 0.01 |
| Particulates | MCEF | Gravimetric | |
| PCBs | GF filter and florisil tube | GC-ECD | 0.001 |
| Pesticides | 13-mm GF filter and chromosorb 102 Tube | GC/MS | 0.05 |

^a MCEF = mixed cellulose ester filter.

GF = glass fiber filler

^b GC/NPD = gas chromatography and nitrogen/phosphorus detector; PCM = phase contrast microscopy; ICP-AES = inductively coupled plasma atomic emission spectrometry; GM/MS = gas chromatography and mass spectrometry; GC/TEA = gas chromatography using a thermal energy analyzer; GC-ECD = gas chromatography using an electrical conductivity detector.

^c Units in fibers per mm² of filter (Method No. 7400 from the NIOSH Manual of Analytical Methods, 3rd edition).

Monitoring for IDLH and Other Dangerous Conditions

As a first step, air monitoring should be conducted to identify any IDLH and other dangerous conditions, such as flammable or explosive atmospheres, oxygen-deficient environments, and highly toxic levels of airborne contaminants. Direct-reading monitoring instruments will normally include combustible gas indicators, oxygen meters, colorimetric indicator tubes, and organic vapor monitors. Other monitoring instruments may be necessary based on the initial site characterization. When time permits, air samples should be collected for laboratory analysis. Extreme caution should be exercised in continuing a site survey when atmospheric hazards are indicated. Monitoring personnel should be aware that conditions can suddenly change from nonhazardous to hazardous.

Acutely hazardous concentrations of chemicals may persist in confined and low-lying spaces for long periods of time. Look for any natural or artificial barriers, such as hills, tall buildings, or tanks, behind which air might be still, allowing concentrations to build up. Examine any confined spaces such as cargo holds, mine shafts, silos, storage tanks, box cars, buildings, bulk tanks, and sumps where chemical exposures capable of causing acute health effects are likely to accumulate. Low-lying areas, such as hollows and trenches, are also suspect. Monitor these spaces for IDLH and other dangerous conditions. Also consider whether the suspected contaminants are lighter or heavier than air. Then, based on the type of contaminants present, consider sampling on hilltops, under any cover or canopy where workers might work or congregate, and in trenches and low-lying areas.

In open spaces, toxic materials tend to be emitted into the atmosphere, transported away from the source, and dispersed. Thus acutely hazardous conditions are not likely to persist in open spaces for extended periods of time unless there is a very large (and hence, readily identifiable) source, such as an overturned tankcar. Open spaces are therefore generally given a lower monitoring priority.

General Onsite Monitoring

Air sampling should be conducted using a variety of media to identify the major classes of airborne contaminants and their concentrations. The following sampling pattern can be used as a guideline. First, after visually identifying the sources of possible generation, collect air samples downwind from the designated source along the axis of the wind direction. Work upwind, until reaching or getting as close as possible to the source. Level B protection (see Table 8-6 in Chapter 8) should be worn during this initial sampling. Levels of protection for subsequent sampling should be based upon the results obtained and the potential for an unexpected release of chemicals.

After reaching the source, or finding the highest concentration, sample cross-axis of the wind direction to determine the degree of dispersion. Smoke plumes, or plumes of instrument-detectable airborne substances, may be released as an aid in this assessment. To ensure that there is no background interference and that the detected substance(s) are originating at the identified source, also collect air samples upwind of the source.

Perimeter Monitoring

Fixed-location monitoring at the "fenceline" or perimeter, where personal protective equipment is no longer required, measures contaminant migration away from the site and enables the Site Safety Officer to evaluate the integrity of the site's clean areas. Since the fixed-location samples may reflect exposures either upwind or downwind from the site, wind speed and direction data are needed to interpret the sample results.

Periodic Monitoring

Site conditions and thus atmospheric chemical conditions may change following the initial characterization. For this reason, monitoring should be repeated periodically, especially when:

- Work begins on a different portion of the site.
- Different contaminants are being handled.
- A markedly different type of operation is initiated (e.g., barrel opening as opposed to exploratory well drilling).
- Workers are handling leaking drums or working in areas with obvious liquid contamination (e.g., a spill or lagoon).

Personal Monitoring

The selective monitoring of high-risk workers, i.e., those who are closest to the source of contaminant generation, is highly recommended. This approach is based on the rationale that the probability of significant exposure varies directly with distance from the source. If workers closest to the source are not significantly exposed, then all other workers are, presumably, also not significantly exposed and probably do not need to be monitored.

Since occupational exposures are linked closely with active material handling, personal air sampling should not be necessary until site mitigation has begun. Personal monitoring samples should be collected in the breathing zone and, if workers are wearing respiratory protective equipment, outside the facepiece. These samples represent the actual inhalation exposure of workers who are not wearing respiratory protection and the potential exposure of workers who are wearing respirators. It is best to use pumps that automatically maintain a constant flow rate to collect samples, since it is difficult to observe and adjust pumps while wearing gloves, respirators, and other personal protective equipment. Pumps should be protected with disposable coverings, such as small plastic bags, to make decontamination procedures easier.

Personal monitoring may require the use of a variety of sampling media. Unfortunately, single workers cannot carry multiple sampling media because of the added strain and because it is not usually possible to draw air through different sampling media using a single portable, battery-operated pump. Consequently, several days may be required to measure the exposure of a specific individual using each of the media [3, 4]. Alternatively, if workers are in teams, a different monitoring device can be assigned to each team member. Another method is to place multiple sampling devices on pieces of heavy equipment. While these are not personal samples, they can be collected very close to the breathing zone of the heavy equipment operator and thus would be reasonably representative of personal exposure. These multimedia samples can yield as much information as several personal samples [5].

When considering employee monitoring, procedures and protocols found in OSHA's Industrial Hygiene Technical Manual may be useful [6].

Variables of Hazardous Waste Site Exposure

Complex, multi-substance environments such as those associated with hazardous waste sites pose significant challenges to accurately and safely assessing airborne contaminants. Several independent and uncontrollable variables, most notably temperature and weather conditions, can affect airborne concentrations. These factors must be considered when developing an air monitoring program and when analyzing data. Some demonstrated variables include:

- Temperature. An increase in temperature increases the vapor pressure of most chemicals.
- Windspeed. An increase in wind speed can affect vapor concentrations near a free-standing liquid surface. Dusts and particulate-bound contaminants are also affected.
- Rainfall. Water from rainfall can essentially cap or plug vapor emission routes from open or closed containers, saturated soil, or lagoons, thereby reducing airborne emissions of certain substances.
- Moisture. Dusts, including finely divided hazardous solids, are highly sensitive to moisture content. This moisture content can vary significantly with respect to location and time and can also affect the accuracy of many sampling results.
- Vapor emissions. The physical displacement of saturated vapors can produce short-term, relatively high vapor concentrations. Continuing evaporation and/or diffusion may produce long-term low vapor concentrations and may involve large areas.
- Work activities. Work activities often require the mechanical disturbance of contaminated materials, which may change the concentration and composition of airborne contaminants.

References

1. Hill, R.H. and J.E. Arnold. 1979. A personal air sampler for pesticides. Arch. Environ. Contam. Toxicol. 8: 621-28.
2. NIOSH. 1984. Manual of Analytical Methods, 4th ed. National Institute for Occupational Safety and Health, Cincinnati, OH.
3. Costello, R.J. 1983. U.S. Environmental Protection Agency Triangle Chemical Site, Bridge City, Texas. NIOSH Health Hazard Evaluations Determination Report HETA 83-417-1357. pp. 6-7.
4. Costello, R.J. and J. Melius. 1981. Technical Assistance Determination Report, Chemical Control, Elizabeth, New Jersey, TA 80-77. National Institute for Occupational Safety and Health, Cincinnati, OH. pp. 20-22.
5. Costello, R.J.; B. Froenberg; and J. Melius. 1981. Health Hazard Evaluation Determination Report, Rollins Environmental Services, Baton Rouge, Louisiana, HE 81-37. National Institute for Occupational Safety and Health, Cincinnati, OH.
6. OSHA. March 30, 1984. Industrial Hygiene Technical Manual. OSHA Instruction CPL 2-2.20A.

8. Personal Protective Equipment (PPE)

Contents

| | |
|--|------|
| Introduction | 8-1 |
| Developing a PPE Program | 8-2 |
| Program Review and Evaluation | 8-2 |
| Selection of Respiratory Equipment | 8-3 |
| Protection Factor | 8-7 |
| Self-Contained Breathing Apparatus (SCBA) | 8-8 |
| Supplied-Air Respirators (SARs) | 8-10 |
| Combination SCBA/SAR | 8-11 |
| Air-Purifying Respirators | 8-11 |
| Selection of Protective Clothing and Accessories | 8-13 |
| Selection of Chemical-Protective Clothing (CPC) | 8-21 |
| Permeation and Degradation | 8-21 |
| Heat Transfer Characteristics | 8-22 |
| Other Considerations | 8-22 |
| Special Conditions | 8-23 |
| Selection of Ensembles | 8-23 |
| Level of Protection | 8-23 |
| PPE Use | 8-24 |
| Training | 8-24 |
| Work Mission Duration | 8-28 |
| Personal Use Factors | 8-29 |
| Donning an Ensemble | 8-30 |
| Respirator Fit Testing | 8-30 |
| In-Use Monitoring | 8-31 |
| Doffing an Ensemble | 8-32 |
| Clothing Reuse | 8-32 |
| Inspection | 8-33 |
| Storage | 8-36 |
| Maintenance | 8-36 |
| Heat Stress and Other Physiological Factors | 8-36 |
| Monitoring | 8-37 |
| Prevention | 8-38 |
| Other Factors | 8-39 |
| References | 8-41 |

Introduction

Anyone entering a hazardous waste site must be protected against potential hazards. The purpose of personal protective clothing and equipment (PPE)¹ is to shield or isolate individuals from the chemical, physical, and biologic hazards that may be encountered at a hazardous waste site. Careful selection and use of adequate PPE should protect the respiratory system, skin, eyes, face, hands, feet, head, body, and hearing. This chapter describes the various types of PPE that are appropriate for use at hazardous waste sites, and provides guidance in their

¹ The term PPE is used in this manual to refer to both personal protective clothing and equipment.

selection and use. The final section discusses heat stress and other key physiological factors that must be considered in connection with PPE use.

Use of PPE is required by Occupational Safety and Health Administration (OSHA) regulations in 29 CFR Part 1910 (see Table 8-1) and reinforced by U.S. Environmental Protection Agency (EPA) regulations in 40 CFR Part 300 which include requirements for all private contractors working on Superfund sites to conform to applicable OSHA provisions and any other federal or state safety requirements deemed necessary by the lead agency overseeing the activities.

No single combination of protective equipment and clothing is capable of protecting against all hazards. Thus PPE should be used in conjunction with other protective methods. The use of PPE can itself create significant worker hazards, such as heat stress, physical and psychological stress, and impaired vision, mobility, and communication. In general, the greater the level of PPE protection, the greater are the associated risks. For any given situation, equipment and clothing should be selected that provide an adequate level of protection. Over-protection as well as under-protection can be hazardous and should be avoided.

Developing a PPE Program

A written PPE program should be established for work at all hazardous waste sites. (OSHA requires a written program for selection and use of respirators 129 CFR Part 1910.1341). Some of the relevant regulations, listed in Table 8-1, are cited throughout the text. The word "shall" is used only when the procedure is mandated by law.

The two basic objectives of any PPE program should be to protect the wearer from safety and health hazards, and to prevent injury to the wearer from incorrect use and/or malfunction of the PPE. To accomplish these goals, a comprehensive PPE program should include hazard identification; medical monitoring; environmental surveillance; selection, use, maintenance, and decontamination of PPE; and training. These subjects are discussed in this chapter and in Chapters 2, 4, 5, 6, 7, and 10.

The written PPE program should include policy statements, procedures, and guidelines. Copies should be made available to all employees, and a reference copy should be available at each work site. Technical data on equipment, maintenance manuals, relevant regulations, and other essential information should also be made available.

Program Review and Evaluation

The PPE program should be reviewed at least annually. Elements which should be considered in the review include:

- A survey of each site to ensure compliance with regulations applicable to the specific site involved.
- The number of person-hours that workers wear various protective ensembles.
- Accident and illness experience.
- Levels of exposure.
- Adequacy of equipment selection.
- Adequacy of the operational guidelines.
- Adequacy of decontamination, cleaning, inspection, maintenance, and storage programs.
- Adequacy and effectiveness of training and fitting programs.
- Coordination with overall safety and health program elements.
- The degree of fulfillment of program objectives.

- The adequacy of program records.
- Recommendations for program improvement and modification.
- Program costs.

The results of the program evaluation should be made available to employees and presented to top management so that program adaptations may be implemented.

Table 8-1. OSHA Standards for Use of PPE

| TYPE OF PROTECTION | REGULATION | SOURCE |
|-------------------------------|----------------------------|--|
| General | 29 CFR Part 1910.132 | 41 CFR Part 50-204.7 General Requirements for Personal Protective Equipment |
| | 29 CFR Part 1910.1000 | 41 CFR Part 50-204.50, except for Table Z-2, the source of which is American National Standards Institute, Z37 series ^a |
| | 29 CFR Part 1910.1001-1045 | OSHA Rulemaking |
| Eye and Face | 29 CFR Part 1910.133(a) | ANSI Z87.1-1968 ^a Eye and Face Protection |
| Noise Exposure | 29 CFR Part 1910.95 | 41 CFR Part 50-204.10 and OSHA Rulemaking |
| Respiratory | 29 CFR Part 1910.134 | ANSI Z88.2-1969 ^a Standard Practice for Respiratory Protection |
| Head | 29 CFR Part 1910.135 | ANSI Z88.2-1969 ^a Standard Practice for Industrial Head Protection |
| Foot | 29 CFR Part 1910.136 | ANSI Z41.1-1967 ^a Men's Safety Toe Footwear |
| Electrical Protective Devices | 29 CFR Part 1910.137 | ANSI Z9.4-1968. Ventilation and Safe Practices of Abrasive Blasting Operations |

^aAmerican National Standards Institute (ANSI), 1430 Broadway, New York, NY 10018. ANSI regularly updates its standards. The ANSI standards in this table are those that OSHA adopted in 1971. Since the ANSI standards which were then adopted had been set in 1967-1969, those standards, now required under OSHA, may be less stringent than the most recent ANSI standards.

Selection of Respiratory Equipment

Respiratory protection is of primary importance since inhalation is one of the major routes of exposure to chemical toxicants. Respiratory protective devices (respirators) consist of a facepiece connected to either an air source or an air-purifying device. Respirators with an air source are called atmosphere-supplying respirators (Figure 8-1) and consist of two types:

- Self-contained breathing apparatus (SCBAs) which supply air from a source carried by the user.

- Supplied-air respirators (SARs) which supply air from a source located some distance away and connected to the user by an air-line hose. Supplied-air respirators are sometimes referred to as air-line respirators.

Air-purifying respirators (Figure 8-2), on the other hand, do not have a separate air source. Instead, they utilize ambient air which is "purified" through a filtering element prior to inhalation.

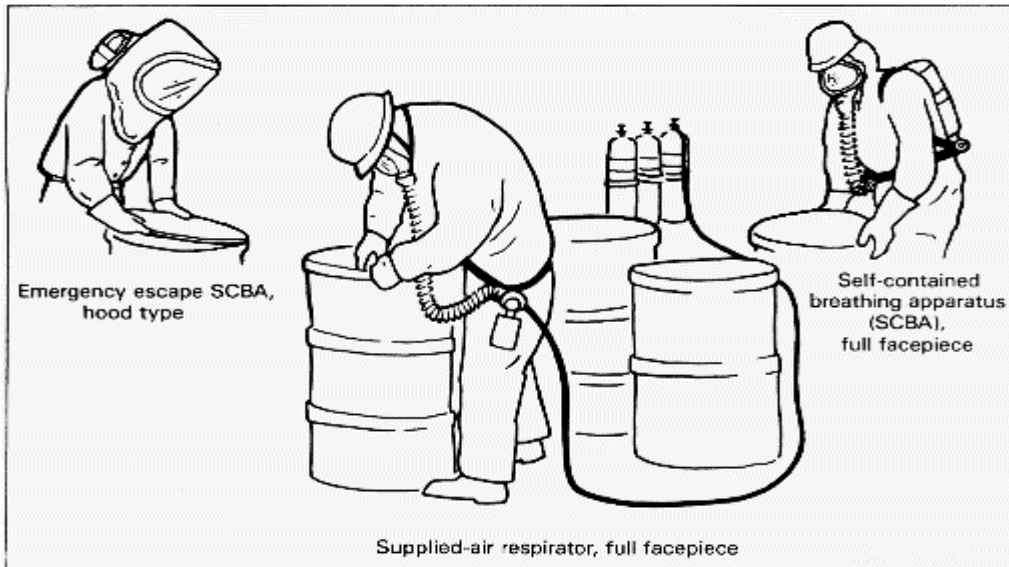

Figure 8-1. Types of Atmosphere-Supplying Respirators.

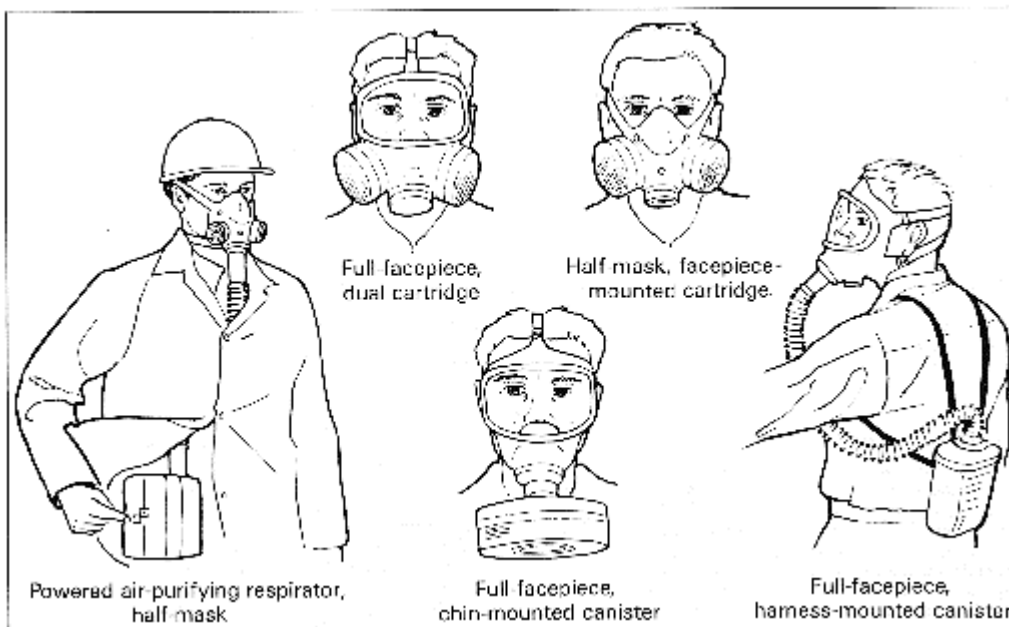

Figure 8-2. Types of Air-Purifying Respirators.

SCBAs, SARs, and air-purifying respirators are further differentiated by the type of air flow supplied to the facepiece:

- *Positive-pressure respirators* maintain a positive pressure in the facepiece during both inhalation and exhalation. The two main types of positive-pressure respirators are pressure-demand and continuous flow. In pressure-demand respirators, a pressure regulator and an exhalation valve on the mask maintain the mask's positive pressure except during high breathing rates. If a leak develops in a pressure-demand respirator, the regulator sends a continuous flow of clean air into the facepiece, preventing penetration by contaminated ambient air. Continuous-flow respirators (including some SARs and all powered air purifying respirators [PAPRs]) send a continuous stream of air into the facepiece at all times. With SARs, the continuous flow of air prevents infiltration by ambient air, but uses the air supply much more rapidly than with pressure-demand respirators. Powered air-purifying respirators (PAPRs) are operated in a positive-pressure continuous-flow mode utilizing filtered ambient air. (However, at maximal breathing rates, a negative pressure may be created in the facepiece of a PAPR.)
- *Negative-pressure respirators* draw air into the facepiece via the negative pressure created by user inhalation. The main disadvantage of negative pressure respirators is that if any leaks develop in the system (i.e., a crack in the hose or an ill-fitting mask or facepiece), the user draws contaminated air into the facepiece during inhalation.

When atmosphere-supplying respirators are used, only those operated in the positive-pressure mode are recommended for work at hazardous waste sites. Table 8-2 lists the relative advantages and disadvantages of SCBAs, SARs, and air-purifying respirators.

Different types of facepieces are available for use with the various types of respirators. The types generally used at hazardous waste sites are full facepieces and half masks.

- *Full-facepiece masks* cover the face from the hairline to below the chin. They provide eye protection.
- *Half masks* cover the face from below the chin to over the nose and do not provide eye protection.

Federal regulations require the use of respirators that have been tested and approved by the Mine Safety and Health Administration (MSHA) and NIOSH. Testing procedures are described in 30 CFR Part 11. Approval numbers are clearly written on all approved respiratory equipment; however, not all respiratory equipment that is marketed is approved. Periodically, NIOSH publishes a list, entitled *NIOSH Certified Equipment List* of all approved respirators and respiratory components [1].

Table 8-2. Relative Advantages and Disadvantages of Respiratory Protective Equipment

| TYPE OF RESPIRATOR | ADVANTAGES | DISADVANTAGES |
|--|--|--|
| ATMOSPHERE-SUPPLYING | | |
| Self-Contained Breathing Apparatus (SCBA) | <ul style="list-style-type: none"> • Provides the highest available level of protection against airborne contaminants and oxygen deficiency • Provides the highest available level of protection under strenuous work conditions. | <ul style="list-style-type: none"> • Bulky, heavy (up to 35 pounds). • Finite air supply limits work duration. • May impair movement in confined spaces. |
| Positive-Pressure Supplied-Air Respirator (SAR) (also called air-line respirator) | <ul style="list-style-type: none"> • Enables longer work periods than an SCBA • Less bulky and heavy than a SCBA. SAR equipment weighs less than 5 pounds (or around 15 pounds if escape SCBA protection is included). • Protects against most airborne contaminants. | <ul style="list-style-type: none"> • Not approved for use in atmospheres immediately dangerous to life or health (IDLH) or in oxygen-deficient atmospheres unless equipped with an emergency egress unit such as an escape-only SCBA that can provide immediate emergency respiratory protection in case of air-line failure. • Impairs mobility • MSHA/NIOSH certification limits hose length to 300 feet (90metersss). • As the length of the hose is increased, the minimum approved air flow may not be delivered at the facepiece. • Air line is vulnerable to damage, chemical contamination, and degradation. Decontamination of hoses may be difficult. • Worker must retrace steps to leave work area. • Requires supervision/monitoring of the air supply line. |

Table 8-2. (cont)

| TYPE OF RESPIRATOR | ADVANTAGES | DISADVANTAGES |
|---|--|--|
| AIR-PURIFYING | | |
| Air-Purifying Respirator (including powered air-purifying respirators [PAPRs]) | <ul style="list-style-type: none"> • Enhanced mobility • Lighter in weight than an SCBA. Generally weights 2 pounds (1 kg) or less (except for PAPRs). | <ul style="list-style-type: none"> • Cannot be used in IDLH or oxygen-deficient atmospheres (less than 19.5 percent oxygen at sea level). • Limited duration of protection. May be hard to gauge safe operating time in field conditions. • Only protects against specific chemicals and up to specific concentrations. • Use requires monitoring of contaminant and oxygen levels. • Can only be used (1) against gas and vapor contaminants with adequate warning properties, or (2) for specific gases or vapors provided that the service is known and a safety factor is applied or if the unit has an ESLI (end-of-service-life indicator). |

Protection Factor

The level of protection that can be provided by a respirator is indicated by the respirator's protection factor. This number, which is determined experimentally by measuring facepiece seal and exhalation valve leakage, indicates the relative difference in concentrations of substances outside and inside the facepiece that can be maintained by the respirator. For example, the protection factor for full-facepiece air-purifying respirators is 50. This means, theoretically, that workers wearing these respirators should be protected in atmospheres containing chemicals at concentrations that are up to 50 times higher than the appropriate limits. One source of protection factors for various types of atmosphere-supplying (SCBA and SAR) and air-purifying respirators can be found in American National Standards Institute (ANSI) standard ANSI Z88.2-1980.

At sites where the identity and concentration of chemicals in air are known, a respirator should be selected with a protection factor that is sufficiently high to ensure that the wearer will not be exposed to the chemicals above the applicable limits. These limits include the American Conference of Governmental Industrial Hygienists' Threshold Limit Values (TLVs), OSHA's Permissible Exposure Limits (PELs), and the NIOSH Recommended Exposure Limits (RELs) (see Table 6-4 in Chapter 6). These limits are designed to protect most workers who may be

exposed to chemicals day after day throughout their working life. The OSHA PELs are legally enforceable exposure limits, and are the minimum limits of protection that must be met.

It should be remembered that the protection provided by a respirator can be compromised in several situations, most notably, (1) if a worker has a high breathing rate, (2) if the ambient temperature is high or low, or (3) if the worker has a poor facepiece-to-face seal. At high breathing rates, positive-pressure SCBAs and SARs may not maintain positive pressure for brief periods during peak inhalation. Also, at high work rates, exhalation valves may leak. Consequently, positive-pressure respirators working at high flow rates may offer less protection than when working at normal rates.

A similar reduction in protection may result from high or low ambient temperatures. For example, at high temperatures excessive sweat may cause a break in the face-to-facepiece seal. At very low temperatures, the exhalation valve and regulator may become ice-clogged due to moisture in the breath and air. Likewise, a poor facepiece seal -due to such factors as facial hair, missing teeth, scars, lack of or improper fit testing, etc. -can result in the penetration of air contaminants.

Self-Contained Breathing Apparatus (SCBA)

A self-contained breathing apparatus (SCBA) usually consists of a facepiece connected by a hose and a regulator to an air source (compressed air, compressed oxygen, or an oxygen-generating chemical) carried by the wearer (see Figure 8-1). Only positive-pressure SCBAs are recommended for entry into atmospheres that are immediately dangerous to life and health (IDLH). SCBAs offer protection against most types and levels of airborne contaminants. However, the duration of the air supply is an important planning factor in SCBA use (see PPE Use later in this chapter). This is limited by the amount of air carried and its rate of consumption. Also, SCBAs are bulky and heavy, thus they increase the likelihood of heat stress and may impair movement in confined spaces. Generally, only workers handling hazardous materials or operating in contaminated zones require SCBAs. Under MSHA regulations in 30 CFR Part 11.70(a), SCBAs may be approved (1) for escape only, or (2) for both entry into and escape from a hazardous atmosphere. The types of SCBAs and their relative advantages and disadvantages are described in Table 8-3.

Escape-only SCBAs are frequently continuous-flow devices with hoods that can be donned to provide immediate emergency protection. Employers should provide and ensure that employees carry an escape SCBA where such emergency protection may be necessary.

Entry-and-escape SCBA respirators give workers untethered access to nearly all portions of the worksite, but decrease worker mobility, particularly in confined areas, due to both the bulk and weight of the units. Their use is particularly advisable when dealing with unidentified and unquantified airborne contaminants. There are two types of entry-and-escape SCBAs: (1) open-circuit and (2) closed-circuit. In an open-circuit SCBA, air is exhaled directly into the ambient atmosphere. In a closed-circuit SCBA, exhaled air is recycled by removing the carbon dioxide with an alkaline scrubber and by replenishing the consumed oxygen with oxygen from a solid, liquid, or gaseous source

As required by MSHA/NIOSH 30 CFR Part 11.80, all compressed breathing gas cylinders must meet minimum U.S. Department of Transportation requirements for interstate shipment. (For further information, see 49 CFR Parts 173 and 178.) All compressed air, compressed oxygen, liquid air, and liquid oxygen used for respiration shall be of high purity and must meet all requirements of OSHA 29 CFR Part 1910.134(d). In addition, breathing air must meet or exceed the requirements of Grade D breathing air as specified in the Compressed Gas Association pamphlet G-7.1 and ANSI Z86.1-1973.

Table 8-3. Types of Self-Contained Breathing Apparatus (SCBA)

| TYPE | DESCRIPTION | ADVANTAGES | DISADVANTAGES | COMMENTS |
|---|---|--|---|---|
| ENTRY-AND-ESCAPE SCBA | | | | |
| Open-Circuit SCBA | Supplies clean air to the wearer from a cylinder. Wearer exhales air directly to the atmosphere. | Operated in a positive-pressure mode, open-circuit SCBAs provide the highest respiratory protection currently available. A warning alarm signals when only 20 to 25 percent of the air supply remains. | Shorter operating time (30 to 60 minutes) and heavier weight (up to 35 lbs [13.6 kg]) than a closed-circuit SCBA. | The 30- to 60-minute operating time may vary depending on the size of the air tank and the work rate of the individual. |
| Closed-Circuit SCBA (Rebreather) | These devices recycle exhaled gases (CO ₂ , O ₂ , and nitrogen) by removing CO ₂ with an alkaline scrubber and replenishing the consumed oxygen with oxygen from a liquid or gaseous source. | Longer operating time (up to 4 hours), and lighter weight (21 to 30 lbs [9.5 to 13.6 kg]) than open-circuit apparatus. A warning alarm signals when only 20 to 25 percent of the oxygen supply remains. Oxygen supply is depleted before the CO ₂ sorbent scrubber supply, thereby protecting the wearer from CO ₂ breakthrough. | At very cold temperatures, scrubber efficiency may be reduced and CO ₂ breakthrough may occur. Units retain the heat normally exchanged in exhalation and generate heat in the CO ₂ scrubbing operations, adding to the danger of heat stress. Auxiliary cooling devices may be required. When worn outside an encapsulating suit, the breathing bag may be permeated by chemicals, contaminating the breathing apparatus and the respirable air. Decontamination of the breathing bag may be difficult. | Positive-pressure closed-circuit SCBAs offer substantially more protection than negative-pressure units, which are not recommended on hazardous waste sites. While these devices may be certified as closed-circuit SCBAs, NIOSH cannot certify closed-circuit SCBAs as positive-pressure devices due to limitations in certification procedures currently defined in 30 CFR Part 11. |
| ESCAPE-ONLY SCBA | Supplies clean air to the wearer from either an air cylinder or from an oxygen-generating chemical. Approved for escape purposes only. | Lightweight (10 pounds [4.5 kg] or less) low bulk, easy to carry. Available in pressure-demand and continuous-flow-modes. | Cannot be used for entry. | Provides only 5 to 15 minutes of respiratory protection, depending on the model and wearer breathing rate. |

Key questions to ask when considering whether an SCBA is appropriate are:

- Is the atmosphere IDLH or is it likely to become IDLH? If yes, a positive-pressure SCBA should be used. A positive-pressure SAR with an escape SCBA can also be used.
- Is the duration of air supply sufficient for accomplishing the necessary tasks? If no, a larger cylinder should be used, a different respirator should be chosen, and/or the Work Plan should be modified.
- Will the bulk and weight of the SCBA interfere with task performance or cause unnecessary stress? If yes, use of an SAR may be more appropriate if conditions permit.
- Will temperature effects compromise respirator effectiveness or cause added stress in the worker? If yes, the work period should be shortened or the mission postponed until the temperature changes.

Supplied-Air Respirators (SARs)

Supplied-air respirators (also known as air-line respirators) supply air, never oxygen, to a facepiece via a supply line from a stationary source (see Figure 8-1). SARs are available in positive-pressure and negative-pressure modes. Pressure-demand SARs with escape provisions provide the highest level of protection (among SARs) and are the only SARs recommended for use at hazardous waste sites. SARs are not recommended for entry into IDLH atmospheres (MSHA/NIOSH 30 CFR Part 11) unless the apparatus is equipped with an escape SCBA.

The air source for supplied-air respirators may be compressed air cylinders or a compressor that purifies and delivers ambient air to the facepiece. SARs suitable for use with compressed air are classified as "Type C" supplied-air respirators as defined in MSHA/NIOSH 30 CFR Part 11. All SAR couplings must be incompatible with the outlets of other gas systems used on site to prevent a worker from connecting to an inappropriate compressed gas source (OSHA 29 CFR 1910.134(d)).

SARs enable longer work periods than do SCBAs and are less bulky. However, the air line impairs worker mobility and requires workers to retrace their steps when leaving the area. Also, the air line is vulnerable to puncture from rough or sharp surfaces, chemical permeation, damage from contact with heavy equipment, and obstruction from failing drums, etc. To the extent possible, all such hazards should be removed prior to use. When in use, air lines should be kept as short as possible (300 feet [91 meters] is the longest approved hose length for SARs), and other workers and vehicles should be kept away from the air line.

The use of air compressors as the air source for an SAR at a hazardous waste site is severely limited by the same concern that requires workers to wear respirators: that is, the questionable quality of the ambient air. Onsite compressor use is limited by OSHA standards (29 CFR Part 1910.134[d]).

Key questions to ask when considering SAR use are:

- Is the atmosphere IDLH or likely to become IDLH? If yes, an SAR/SCBA combination or SCBA should be used.
- Will the hose significantly impair worker mobility? If yes, the work task should be modified or other respiratory protection should be used.
- Is there a danger of the air line being damaged or obstructed (e.g., by heavy equipment, failing drums, rough terrain, or sharp objects) or permeated and/or degraded by chemicals (e.g., by pools of chemicals)? If yes, either the hazard should be removed or another form of respiratory protection should be used.
- If a compressor is the air source, is it possible for airborne contaminants to enter the air system? If yes, have the contaminants been identified and are efficient filters and/or

sorbents available that are capable of removing those contaminants? If no, either cylinders should be used as the air source or another form of respiratory protection should be used.

- Can other workers and vehicles that might interfere with the air line be kept away from the area? If no, another form of respiratory protection should be used.

Combination SCBA/SAR

A relatively new type of respiratory protection is available that uses a regulator to combine the features of an SCBA with an SAR. The user can operate the respirator in the SCBA or SAR mode, through either the manual or automatic switching of air sources. This type of respirator allows entry into and exit from an area using the self contained air supply, as well as extended work periods within a contaminated area while connected to the air line. It is particularly appropriate for sites where workers must travel an extended distance to a work area within a hot zone and remain within that area for relatively long work periods (e.g., drum sampling). In such situations, workers would enter the site using the SCBA mode, connect to the air line during the work period, and shift back to the SCBA mode to leave the site.

The combination SCBA/SAR should not be confused with an SAR with escape provisions. The primary difference is the length of air time provided by the SCBA; the combination system provides up to 60 minutes of self-contained air, whereas the escape SCBA contains much less air, generally enough for only 5 minutes. NIOSH certification of the combination unit allows up to 20 percent of the available air time to be used during entry, while the SAR with escape provision is certified for escape only.

Air-Purifying Respirators

Air-purifying respirators consist of a facepiece and an air-purifying device, which is either a removable component of the facepiece or an air-purifying apparatus worn on a body harness and attached to the facepiece by a corrugated breathing hose (see Figure 8-2). Air-purifying respirators selectively remove specific airborne contaminants (particulates, gases, vapors, fumes) from ambient air by filtration, absorption, adsorption, or chemical reactions. They are approved for use in atmospheres containing specific chemicals up to designated concentrations, *and not for IDLH atmospheres*. Air-purifying respirators have limited use at hazardous waste sites and can be used only when the ambient atmosphere contains sufficient oxygen (19.5 percent) (30 CFR Part 11.90[a]). Table 8-4 lists conditions that may exclude the use of air-purifying respirators.

Air-purifying respirators usually operate only in the negative-pressure mode except for powered air-purifying respirators (PAPRs) which maintain a positive facepiece pressure (except at maximal breathing rates). There are three types of air-purifying devices: (1) particulate filters; (2) cartridges and canisters, which contain sorbents for specific gases and vapors; and (3) combination devices. Their efficiencies vary considerably even for closely related materials [2].

Cartridges usually attach directly to the respirator facepiece. The larger-volume canisters attach to the chin of the facepiece or are carried with a harness and attached to the facepiece by a breathing tube. Combination canisters and cartridges contain layers of different sorbent materials and remove multiple chemicals or multiple classes of chemicals from the ambient air. Though approved against more than one substance, these canisters and cartridges are tested

Table 8-4. Conditions that Exclude or May Exclude Use of Air-Purifying Respirators

- Oxygen deficiency.
- IDLH concentrations of specific substances.
- Entry into an unventilated or confined area where the exposure conditions have not been characterized.
- Presence or potential presence of unidentified contaminants.
- Contaminant concentrations are unknown or exceed designated maximum use concentration(s).
- Identified gases or vapors have inadequate warning properties *and* the sorbent service life is not known *and* the unit has no end-of-service-life (ESLI) indicator.
- High relative humidity (may reduce the protection offered by the sorbent).

or more substances has not been demonstrated. Filters may also be combined with cartridges to provide additional protection against particulates. A number of standard cartridges and canisters are commercially available. They are color-coded to indicate the general chemicals or classes of chemicals against which they are effective (29 CFR Part 1910.134[g]).

MSHA and NIOSH have granted approvals for manufacturers' specific assemblies of air-purifying respirators for a limited number of specific chemicals. Respirators should be used only for those substances for which they have been approved. Use of a sorbent shall not be allowed when there is reason to suspect that it does not provide adequate sorption efficiency against a specific contaminant. In addition, it should be noted that approval testing is performed at a given temperature and over a narrow range of flow rates and relative humidities [3]; thus protection may be compromised in nonstandard conditions. The assembly that has been approved by MSHA and NIOSH to protect against organic vapors is tested against only a single challenge substance, carbon tetrachloride; its effectiveness for protecting against other vapors has not been demonstrated.

Most chemical sorbent canisters are imprinted with an expiration date. They may be used up to that date as long as they were not opened previously. Once opened, they begin to absorb humidity and air contaminants whether or not they are in use. Their efficiency and service life decreases and therefore they should be used immediately. Cartridges should be discarded after use but should not be used for longer than one shift or when breakthrough occurs, whichever comes first.

Where a canister or cartridge is being used against gases or vapors, the appropriate device shall be used only if the chemical(s) have "adequate warning properties" (30 CFR Part 11.150). NIOSH considers a substance to have adequate warning properties when its odor, taste, or irritant effects are detectable and persistent at concentrations below the recommended exposure limit (REL) (see Chapter 6). A substance is considered to have poor warning properties when its odor or irritation threshold is above the applicable exposure limit. Warning properties are essential to safe use of air-purifying respirators since they allow detection of contaminant breakthrough, should it occur. While warning properties are not foolproof, because they rely on human senses which vary widely among individuals and in the same individual under varying conditions (e.g., olfactory fatigue), they do provide some indication of possible sorbent exhaustion, poor facepiece fit, or other malfunctions. OSHA permits the use of air-purifying respirators for protection against specific chemicals with poor warning properties provided that (1) the service life of the sorbent is known and a safety factor has been applied or (2) the respirator has an approved end-of-service-life indicator.

Selection of Protective Clothing and Accessories

In this manual, personal protective clothing is considered to be any article offering skin and/or body protection. It includes:

- Fully-encapsulating suits.
- Non-encapsulating suits.
- Aprons, leggings, and sleeve protectors.
- Gloves.
- Firefighters' protective clothing.
- Proximity, or approach, garments.
- Blast and fragmentation suits.
- Cooling garments.
- Radiation-protective suits.

Each type of protective clothing has a specific purpose; many, but not all, are designed to protect against chemical exposure. Examples of protective clothing are shown in Figure 8-3.

Table 8-5 describes various types of protective clothing available, details the type of protection they offer, and lists the factors to consider in their selection and use. This table also describes a number of accessories that might be used in conjunction with a PPE ensemble, namely:

- Knife.
- Flashlight or lantern.
- Personal locator beacon.
- Personal dosimeters.
- Two-way radio.
- Safety belts and lines.

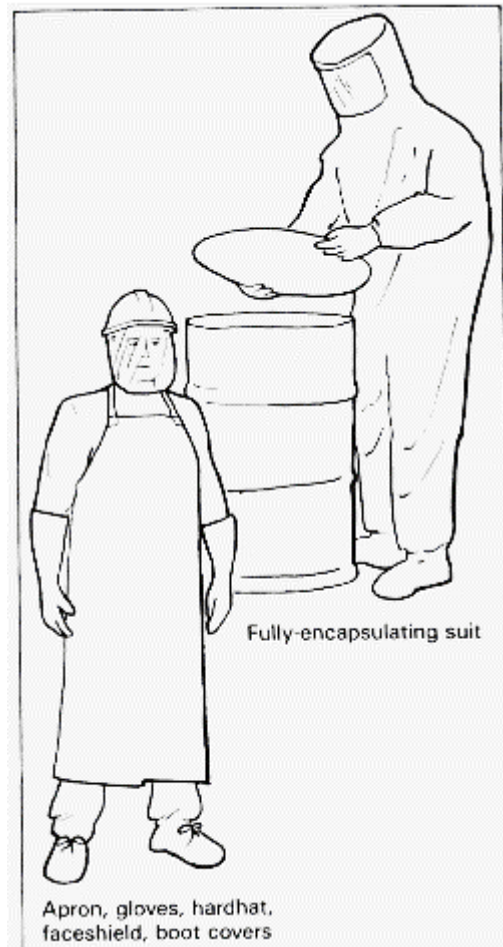

Figure 8-3. Examples of Protective Clothing.

Table 8-5. Protective Clothing and Accessories

| BODY PART PROTECTED | TYPE OF CLOTHING OR ACCESSORY | DESCRIPTION | TYPE OF PROTECTION | USE CONSIDERATIONS |
|---------------------|---|--|--|---|
| Full Body | Fully-encapsulating suit | One-piece garment. Boots and gloves may be integral, attached and replaceable, or separate. | Protects against splashes, dust, gases, and vapors. | Does not allow body heat to escape. May contribute to heat stress in wearer, particularly if worn in conjunction with a closed-circuit SCBA; a cooling garment may be needed. Impairs worker mobility, vision, and communication. |
| | Non-encapsulating suit | Jacket, hood, pants, or bib overalls, and one-piece coveralls. | Protects against splashes, dust, and other materials but not against gases and vapors. Does not protect parts of head or neck. | Do not use where gas-tight or pervasive splashing protection is required. May contribute to heat stress in wearer. Tape-seal connections between pant cuffs and boots and between gloves and sleeves. |
| | Aprons, leggings, and sleeve protectors | Fully sleeved and gloved apron. Separate coverings for arms and legs. Commonly worn over non-encapsulating suit. | Provides additional splash protection of chest, forearms, and legs. | Whenever possible, should be used over a non-encapsulating suite (instead of using a fully-encapsulating suite) to minimize potential for heat stress. Useful for sampling, labeling, and analysis operations. Should be used only when there is a low probability of total body contact with contaminants. |

Table 8-5. (cont.)

| BODY PART PROTECTED | TYPE OF CLOTHING OR ACCESSORY | DESCRIPTION | TYPE OF PROTECTION | USE CONSIDERATIONS |
|-----------------------------|-----------------------------------|--|--|--|
| Full Body (cont.) | Firefighters' protective clothing | Gloves, helmet, running or bunker coat, running or bunker pants (NFPA No. 1971, 1972, 1973), and boots. | Protects against heat, hot water, and some particles. Does not protect against gases and vapors, or chemical permeation or degradation. NFPA Standard No. 1971 specified that a garment consist of an outer shell, an inner liner, and a vapor barrier with a minimum water penetration of 25 lbs/in ² (1.8 kg/cm ²) to prevent the passage of hot water. | Decontamination is difficult. Should not be worn in areas where protection against gases, vapors, chemical splashes, or permeation is required. |
| | Proximity garment (approach suit) | One- or two-piece overgarment with boot covers, gloves and hood of aluminized nylon or cotton fabric. Normally worn over other protective clothing, such as chemical-protective clothing, firefighters' bunker gear, or flame-retardant coveralls. | Protects against brief exposure to radiant heat. Does not protect against chemical permeation or degradation. Can be custom-manufactured to protect against some chemical contaminants. | Auxiliary cooling and an SCBA should be used if the wearer may be exposed to a toxic atmosphere or needs more than 2 or 3 minutes of protection. |
| | Blast and fragmentation suit | Blast and fragmentation vests and clothing, bomb blankets, and bomb carriers. | Provides some protection against very small detonations. Bomb blankets and baskets can help redirect a blast. | Does not provide hearing protection. |

Table 8-5. (cont.)

| BODY PART PROTECTED | TYPE OF CLOTHING OR ACCESSORY | DESCRIPTION | TYPE OF PROTECTION | USE CONSIDERATIONS |
|-----------------------------|---|--|---|--|
| Full Body (cont.) | Radiation-contamination protective suit | Various types of protective clothing designed to prevent contamination of the body by radioactive particles. | Protects against alpha and beta particles. <i>Does NOT protect against gamma radiation.</i> | Designed to prevent skin contamination. If radiation is detected on site, consult an experienced radiation expert and evacuate personnel until the radiation hazard has been evaluated. |
| | Flame/fire retardant coveralls | Normally worn as an undergarment. | Provides protection from flash fires. | Adds bulk and may exacerbate heat stress problems and impair mobility. |
| | Flotation gear | Life jackets or work vests. (Commonly worn underneath chemical protective clothing to prevent flotation gear degradation by chemicals.) | Adds 15.5 to 25 lbs (7 to 11.3 kg) of buoyancy to personnel working in or around water | Adds bulk and restricts mobility. Must meet USCG standards (46 CFR Part 160). |
| | Cooling Garment | One of three methods: (1) A pump circulates cool dry air throughout the suit or portions of it via an air line. Cooling may be enhanced by use of a vortex cooler, refrigeration coils, or a heat exchanger. (2) A jacket or vest having pockets into which packets of ice are inserted. (3) A pump circulates chilled water from a water/ice reservoir and through circulating tubes, which cover part of the body (generally the upper torso only). | Removes excess heat generated by worker activity, the equipment, or the environment. | (1) Pumps circulating cool air require 10 to 20 ft ³ (0.3 to 0.6 m ³) of respirable air per minute, so they are often uneconomical for use at a waste site. (2) Jackets or vests pose ice storage and recharge problems. (3) Pumps circulating chilled water pose ice storage problems. The pump and battery add bulk and weight. |

Table 8-5. (cont.)

| BODY PART PROTECTED | TYPE OF CLOTHING OR ACCESSORY | DESCRIPTION | TYPE OF PROTECTION | USE CONSIDERATIONS |
|----------------------------------|-------------------------------|---|--|--|
| Head | Safety helmet (hard hat) | For example, a hard plastic or rubber helmet. | Protects the head from blows. | Helmet shall meet OSHA standard 29 CFR part 1910.135. |
| | Helmet liner | | Insulates against cold. Does not protect against chemical splashes. | |
| | Hood | Commonly worn with a helmet. | Protects against chemical splashes, particulates, and rain. | |
| | Protective hair covering | | Protects against chemical contamination of hair. Prevents the entanglement of hair in machinery or equipment. Prevents hair from interfering with vision and with the functioning of respiratory protective devices. | Particularly important for workers with long hair. |
| Eyes and Face^a | Face shield | Full-face coverage, eight-inch minimum. | Protects against chemical splashes. Does not protect adequately against projectiles. | Face shields and splash hoods must be suitably supported to prevent them from shifting and exposing portions of the face or obscuring vision. Provides limited eye protection. |
| | Splash hood | | Protects against chemical splashes. Does not protect adequately against projectiles. | |
| | Safety glasses | | Protect eyes against large particles and projectiles. | If lasers are used to survey a site, workers should wear special protective lenses. |

Table 8-5. (cont.)

| BODY PART PROTECTED | TYPE OF CLOTHING OR ACCESSORY | DESCRIPTION | TYPE OF PROTECTION | USE CONSIDERATIONS |
|--------------------------------|-------------------------------|--|---|---|
| Eye and Face (cont.) | Goggles | | Depending on their construction, goggles can protect against vaporized chemicals, splashes, large particles, and projectiles (if constructed with impact-resistant lenses). | |
| | Sweat bands | | Prevents sweat-induced eye irritation and vision impairment. | |
| Ears | Ear plugs and muffs | | Protect against physiological damage and psychological disturbance. | Must comply with OSHA regulation 29 CFR Part 1910.95. Can interfere with communication. Use of ear plugs should be carefully reviewed by a health and safety professional because chemical contaminants could be introduced into the ear. |
| | Headphones | Radio headset with throat microphone. | Provide some hearing protection while enabling communication. | Highly desirable, particularly if emergency conditions arise. |
| Hands and Arms | Gloves and sleeves | May be integral, attached, or separate from other protective clothing. | Protect hands and arms from chemical contact. | Wear jacket cuffs over glove cuffs to prevent liquid from entering the glove. Tape-seal gloves to sleeves to provide additional protection. |
| | | Overgloves. | Provide supplemental protection to the wearer and protect more expensive undergarments from abrasions, tears, and contamination. | |

Table 8-5. (cont.)

| BODY PART PROTECTED | TYPE OF CLOTHING OR ACCESSORY | DESCRIPTION | TYPE OF PROTECTION | USE CONSIDERATIONS |
|-------------------------------|--------------------------------|--|--|--|
| Hands and Arms (cont.) | | Disposable gloves. | Should be used whenever possible to reduce decontamination needs. | |
| Foot | Safety boots | Boots constructed of chemical-resistant material. | Protect feet from contact with chemicals. | |
| | | Boots constructed with some steel materials (e.g., toes, shanks, insoles). | Protect feet from compression, crushing, or puncture by falling, moving, or sharp objects. | All boots must at least meet the specifications required under OSHA 29 CFR Part 1910.136 and should provide good traction. |
| | | Boots constructed from nonconductive, spark-resistant materials or coatings. | Protect the wearer against electrical hazards and prevent ignition of combustible gases or vapors. | |
| | Disposable shoe or boot covers | Made of a variety of materials. Slip over the shoe or boot. | Protect safety boots from contamination. Protect feet from contact with chemicals. | Covers may be disposed of after use, facilitating decontamination. |
| General | Knife | | Allows a person in a fully-encapsulating suit to cut his or her way out of the suit in the event of an emergency or equipment failure. | Should be carried and used with caution to avoid puncturing the suit. |

Table 8-5. (cont.)

| BODY PART PROTECTED | TYPE OF CLOTHING OR ACCESSORY | DESCRIPTION | TYPE OF PROTECTION | USE CONSIDERATIONS | |
|---------------------------|-------------------------------|---------------------------------------|--|--|---|
| General (cont.) | Flashlight or lantern | | Enhances visibility in buildings, enclosed spaces, and the dark. | Must be intrinsically safe or explosion-proof for use in combustible atmospheres. Sealing the flashlight in a plastic bag facilitates decontamination. Only electrical equipment approved as intrinsically safe, or approved for the class and group of hazard as defined in Article 500 of the National Electrical Code, may be used. | |
| | | Personal dosimeter | | Measures worker exposure to ionizing radiation and to certain chemicals. | To estimate actual body exposure, the dosimeter should be placed inside the fully-encapsulating suit. |
| | | Personal locator beacon | Operated by sound, radio, or light | Enables emergency personnel to locate victim. | |
| | | Two-way radio | | Enables field workers to communicate with personnel in the Support Zone. | |
| | | Safety belts, harnesses, and lifeline | | Enable personnel to work in elevated areas or enter confined areas and prevent falls. Belts may be used to carry tools and equipment. | Must be constructed of spark-free hardware and chemical-resistant materials to provide proper protection. Must meet OSHA standards in 29 CFR Part 1926.104. |

Selection of Chemical-Protective Clothing (CPC)

Chemical-protective clothing (CPC) is available in a variety of materials that offer a range of protection against different chemicals. The most appropriate clothing material will depend on the chemicals present and the task to be accomplished. Ideally, the chosen material resists permeation, degradation, and penetration. Permeation is the process by which a chemical dissolves in and/or moves through a protective clothing material on a molecular level. Degradation is the loss of or change in the fabric's chemical resistance or physical properties due to exposure to chemicals, use, or ambient conditions (e.g., sunlight). Penetration is the movement of chemicals through zippers, stitched seams or imperfections (e.g., pinholes) in a protective clothing material.

Selection of chemical-protective clothing is a complex task and should be performed by personnel with training and experience. Under all conditions, clothing is selected by evaluating the performance characteristics of the clothing against the requirements and limitations of the site- and task-specific conditions. If possible, representative garments should be inspected before purchase and their use and performance discussed with someone who has experience with the clothing under consideration. In all cases, the employer is responsible for ensuring that the personal protective clothing (and all PPE) necessary to protect employees from injury or illness that may result from exposure to hazards at the work site is adequate and of safe design and construction for the work to be performed (see OSHA standard 29 CFR Part 1910.132, 1910.137).

Permeation and Degradation

The selection of chemical-protective clothing depends greatly upon the type and physical state of the contaminants. This information is determined during site characterization (Chapter 6). Once the chemicals have been identified, available information sources should be consulted to identify materials that are resistant to permeation and degradation by the known chemicals. One excellent reference, *Guidelines for the Selection of Chemical-Protective Clothing* [4], provides a matrix of clothing material recommendations for approximately 300 chemicals based on an evaluation of permeation and degradation data from independent tests, vendor literature, and raw material suppliers. Charts indicating the resistance of various clothing materials to permeation and degradation are also available from manufacturers and other sources. It is important to note, however, that no material protects against all chemicals and combinations of chemicals, and that no currently available material is an effective barrier to any prolonged chemical exposure.

In reviewing vendor literature, it is important to be aware that the data provided are of limited value. For example, the quality of vendor test methods is inconsistent; vendors often rely on the raw material manufacturers for data rather than conducting their own tests; and the data may not be updated. In addition, vendor data cannot address the wide variety of uses and challenges to which CPC may be subjected. Most vendors strongly emphasize this point in the descriptive text that accompanies their data.

Another factor to bear in mind when selecting CPC is that the rate of permeation is a function of several factors, including clothing material type and thickness, manufacturing method, the concentration(s) of the hazardous substance(s), temperature, pressure, humidity, the solubility of the chemical in the clothing material, and the diffusion coefficient of the permeating chemical in the clothing material. Thus permeation rates and breakthrough time (the time from initial exposure until hazardous material is detectable on the inside of the CPC) may vary depending on these conditions.

Most hazardous wastes are mixtures, for which specific data with which to make a good CPC selection are not available. Due to a lack of testing, only limited permeation data for multi-component liquids are currently available.

Mixtures of chemicals can be significantly more aggressive towards CPC materials than can any single component alone. Even small amounts of a rapidly permeating chemical may provide a pathway that accelerates the permeation of other chemicals [4]. Formal research is being conducted on these effects. NIOSH is currently developing methods for evaluating CPC materials against mixtures of chemicals and unknowns in the field. For hazardous waste site operations, CPC should be selected that offers the widest range of protection against the chemicals expected on site. Vendors are now providing CPC material composed of two or even three different materials laminated together that is capable of providing the best features of each material.

Heat Transfer Characteristics

The heat transfer characteristics of CPC may be an important factor in selection. Since most chemical-protective clothing is virtually impermeable to moisture, evaporative cooling is limited. The "clo" value (thermal insulation value) of chemical-protective clothing is a measure of the capacity of CPC to dissipate heat loss through means other than evaporation. The larger the clo value, the greater the insulating properties of the garment and, consequently, the lower the heat transfer [5]. Given other equivalent protective properties, clothing with the lowest clo value should be selected in hot environments or for high work rates. Unfortunately, clo values for clothing are rarely available at present.

Other Considerations

In addition to permeation, degradation, penetration, and heat transfer, several other factors must be considered during clothing selection. These affect not only chemical resistance, but also the worker's ability to perform the required task. The following checklist summarizes these considerations.

- Durability:
 - Does the material have sufficient strength to withstand the physical stress of the task(s) at hand?
 - Will the material resist tears, punctures, and abrasions?
 - Will the material withstand repeated use after contamination/decontamination?
- Flexibility:
 - Will the CPC interfere with the workers' ability to perform their assigned tasks (this is particularly important to consider for gloves)?
- Temperature effects:
 - Will the material maintain its protective integrity and flexibility under hot and cold extremes?
- Ease of decontamination:
 - Are decontamination procedures available on site?
 - Will the material pose any decontamination problems?
 - Should disposable clothing be used?
- Compatibility with other equipment:
 - Does the clothing preclude the use of another, necessary piece of protective equipment (e.g., suits that preclude hardhat use in hardhat area)?
- Duration of use:

- Can the required task be accomplished before contaminant breakthrough occurs, or degradation of the CPC becomes significant?

Special Conditions

Fire, explosion, heat, and radiation are considered special conditions that require special-protective equipment. Unique problems are associated with radiation and it is beyond the scope of this manual to discuss them properly. A qualified health physicist should be consulted if a radiation hazard exists. Special-protective equipment is described in Table 8-5 (see Full Body section of the table). When using special-protective equipment, it is important to also provide protection against chemicals, since the specialized equipment may provide little or no protection against chemicals which may also be present.

Selection of Ensembles

Level of Protection

The individual components of clothing and equipment must be assembled into a full protective ensemble that both protects the worker from the site-specific hazards and minimizes the hazards and drawbacks of the PPE ensemble itself.

Table 8-6 lists ensemble components based on the widely used EPA Levels of Protection: Levels A, B, C, and D. These lists can be used as a starting point for ensemble creation; however, each ensemble must be tailored to the specific situation in order to provide the most appropriate level of protection. For example, if work is being conducted at a highly contaminated site or if the potential for contamination is high, it may be advisable to wear a disposable covering, such as Tyvek coveralls or PVC splash suits, over the protective ensemble. It may be necessary to slit the back of these disposable suits to fit around the bulge of an encapsulating suit and SCBA [6].

The type of equipment used and the overall level of protection should be reevaluated periodically as the amount of information about the site increases, and as workers are required to perform different tasks. Personnel should be able to upgrade or downgrade their level of protection with concurrence of the Site Safety Officer and approval of the Field Team Leader.

Reasons to upgrade:

- Known or suspected presence of dermal hazards.
- Occurrence or likely occurrence of gas or vapor emission.
- Change in work task that will increase contact or potential contact with hazardous materials.
- Request of the individual performing the task.

Reasons to downgrade:

- New information indicating that the situation is less hazardous than was originally thought.
- Change in site conditions that decreases the hazard.
- Change in work task that will reduce contact with hazardous materials.

PPE Use

PPE can offer a high degree of protection only if it is used properly. This section covers the following aspects of PPE use:

- Training.
- Work mission duration.
- Personal use factors.
- Fit testing.
- Donning.
- In-use monitoring.
- Doffing.
- Inspection.
- Storage.
- Maintenance.

Decontamination is covered in Chapter 10. Inadequate attention to any of these areas could compromise the protection provided by the PPE.

Training

Training in PPE use is recommended and, for respirators, required by federal regulation in the OSHA standards in 29 CFR Part 1910 Subparts I and Z. This training:

- Allows the user to become familiar with the equipment in a nonhazardous situation.
- Instills confidence of the user in his/her equipment.
- Makes the user aware of the limitations and capabilities of the equipment.
- Increases the efficiency of operations performed by workers wearing PPE.
- May increase the protective efficiency of PPE use.
- Reduces the expense of PPE maintenance.

Training should be completed prior to actual PPE use in a hazardous environment and should be repeated at least annually. At a minimum, the training portion of the PPE program should delineate the user's responsibilities and explain the following, utilizing both classroom and field training when necessary:

- OSHA requirements as delineated in 29 CFR Part 1910 Subparts I and Z.
- The proper use and maintenance of the selected PPE, including capabilities and limitations.
- The nature of the hazards and the consequences of not using the PPE.
- The human factors influencing PPE performance.
- Instruction in inspecting, donning, checking, fitting, and using PPE.
- Individualized respirator fit testing to ensure proper fit.
- Use of PPE in normal air for a long familiarity period and, finally, wearing PPE in a test atmosphere to evaluate its effectiveness.

Table 8-6. Sample Protective Ensembles^a

| LEVEL OF PROTECTION | EQUIPMENT | PROTECTION PROVIDED | SHOULD BE USED WHEN: | LIMITING CRITERIA |
|---------------------|---|--|--|---|
| A | <p>RECOMMENDED:</p> <ul style="list-style-type: none"> • Pressure-demand, full-facepiece SCBA or pressure-demand supplied air respirator with escape SCBA. • Fully-encapsulating, chemical-resistant suit. • Inner chemical-resistant gloves. • Chemical-resistant safety boots/shoes. • Two-way radio communications. <p>OPTIONAL:</p> <ul style="list-style-type: none"> • Cooling unit. • Coveralls. • Long Cotton underwear. • Hard hat. • Disposable gloves and boot covers. | <p>The highest available level of respiratory, skin and eye protection.</p> | <ul style="list-style-type: none"> • The chemical substance has been identified and requires the highest level of protection for skin, eyes, and the respiratory system based on either: <ul style="list-style-type: none"> - Measured (or potential for) high concentration of atmospheric vapors, gases, or particulates or - site operations and work functions involving a high potential for splash, immersion, or exposure to unexpected vapors, gases, or particulates of materials that are harmful to skin or capable of being absorbed through the intact skin. • Substances with a high degree of hazard to the skin are known or suspected to be present, and skin contact is possible. • Operations must be conducted in confined, poorly ventilated areas until the absence of conditions requiring Level A protection is determined. | <ul style="list-style-type: none"> • Fully-encapsulating suit material must be compatible with the substances involved. |
| B | <p>RECOMMENDED:</p> <ul style="list-style-type: none"> • Pressure-demand, full-facepiece SCBA or pressure-demand supplied-air respirator with escape SCBA. • Chemical-resistant clothing (coveralls and long-sleeved jacket; hooded, one- or two-piece chemical splash suit; disposable chemical-resistant one-piece suit). | <p>The same level of respiratory protection but less skin protection than Level A.</p> | <ul style="list-style-type: none"> • The type and atmospheric concentration of substances have been identified and require a high level of respiratory protection, but less skin protection. This involves atmospheres: <ul style="list-style-type: none"> - with IDLH concentrations of specific substances that do not represent a severe skin hazard; or - that do not meet the criteria for use of air-purifying respirators. | <ul style="list-style-type: none"> • Use only when the vapor or gases present are not suspected of containing high concentrations of chemicals that are harmful to skin or capable of being absorbed through the intact skin. • Use only when it is highly unlikely that the work being done will generate either high concentrations of vapors, gases, or particulates, or splashes of material that will affect exposed skin. |

Table 8-6. (cont.)

| LEVEL OF PROTECTION | EQUIPMENT | PROTECTION PROVIDED | SHOULD BE USED WHEN: | LIMITING CRITERIA |
|---------------------|---|---|---|--|
| B (cont.) | <ul style="list-style-type: none"> • Inner and outer chemical-resistant gloves. • Chemical-resistant safety boots/shoes.. • Hard hat. • Two-way radio communications. <p>OPTIONAL:</p> <ul style="list-style-type: none"> • Coveralls. • Disposable boot covers. • Face shield. • Long cotton underwear. | <p>It is the minimum level recommended for initial site entries until the hazards have been further identified.</p> | <ul style="list-style-type: none"> • Atmosphere contains less than 19.5 percent oxygen. • Presence of incompletely identified vapors or gases is indicated by direct-reading organic vapor detection instrument, but vapors and gases are not suspected of containing high levels of chemicals harmful to skin or capable of being absorbed through the intact skin. | |
| C | <p>RECOMMENDED:</p> <ul style="list-style-type: none"> • Full-facepiece, air-purifying, canister-equipped respirator. • Chemical-resistant clothing (overalls and long-sleeved jacket; hooded, one- or two-piece chemical splash suit; disposable chemical-resistant one-piece suit). • Inner and outer chemical-resistant gloves. • Chemical-resistant safety boots/shoes.. • Hard hat. • Two-way radio communications. <p>OPTIONAL:</p> <ul style="list-style-type: none"> • Coveralls. • Disposable boot covers. • Face shield. • Escape mask. • Long cotton underwear. | <p>The same level of skin protection as level B, but a lower level of respiratory protection.</p> | <ul style="list-style-type: none"> • The atmospheric contaminants, liquid splashes, or other direct contact will not adversely affect any exposed skin. • The types of air contaminants have been identified, concentrations measured, and a canister is available that can remove the contaminant. • All criteria for the use of air-purifying respirators are met. | <ul style="list-style-type: none"> • Atmospheric concentration of chemicals must not exceed IDLH levels. • The atmosphere must contain at least 19.5 percent oxygen. |

Table 8-6. (cont.)

| LEVEL OF PROTECTION | EQUIPMENT | PROTECTION PROVIDED | SHOULD BE USED WHEN: | LIMITING CRITERIA |
|---------------------|---|---|---|---|
| D | <p>RECOMMENDED:</p> <ul style="list-style-type: none"> • Coveralls. • Safety boots/shoes. • Safety glasses or chemical splash goggles. • Hard hat. <p>OPTIONAL:</p> <ul style="list-style-type: none"> • Gloves. • Escape mask. • Face shield. | <p>No respiratory protection.</p> <p>Minimal skin protection.</p> | <ul style="list-style-type: none"> • The atmosphere contains no known hazard. • Work functions preclude splashes, immersion, or the potential for unexpected inhalation of or contact with hazardous levels of any chemicals. | <ul style="list-style-type: none"> • This level should not be worn in the Exclusion Zone. • The atmosphere must contain at least 19.5 percent oxygen. |

^aBased on EPA protective ensembles.

- The user's responsibility (if any) for decontamination, cleaning, maintenance, and repair of PPE.
- Emergency procedures and self-rescue in the event of PPE failure.
- The buddy system (see Chapter 9, *Site Control*).
- The Site Safety Plan and the individual's responsibilities and duties in an emergency.

The discomfort and inconvenience of wearing PPE can create a resistance to the conscientious use of PPE. One essential aspect of training is to make the user aware of the need for PPE and to instill motivation for the proper use and maintenance of PPE.

Work Mission Duration

Before the workers actually begin work in their PPE ensembles, the anticipated duration of the work mission should be established. Several factors limit mission length. These include:

- Air supply consumption.
- Suit/ensemble permeation and penetration by chemical contaminants.
- Ambient temperature.
- Coolant supply.

Air Supply Consumption

The duration of the air supply must be considered before planning any SCBA-assisted work activity. The anticipated operating time of an SCBA is clearly indicated on the breathing apparatus. This designated operating time is based on a moderate work rate, e.g., some lifting, carrying, and/or heavy equipment operation.

In actual operation, however, several factors can reduce the rated operating time when planning an SCBA-assisted work mission, the following variables should be considered and work actions and operating time adjusted accordingly:

- Work rate. The actual in-use duration of SCBAs may be reduced by one-third to one-half during strenuous work, e.g., drum handling, major lifting, or any task requiring repetitive speed of motion [7].
- Fitness. Well-conditioned individuals generally utilize oxygen more efficiently and can extract more oxygen from a given volume of air (particularly when performing strenuous tasks) than unfit individuals, thereby slightly increasing the SCBA operating time [8].
- Body size. Larger individuals generally consume air at a higher rate than smaller individuals [8], thereby decreasing the SCBA operating time.
- Breathing patterns. Quick, shallow or irregular breaths use air more rapidly than deep, regularly spaced breaths. Heat-induced anxiety and lack of acclimatization (see Heat Stress and Other Physiological Factors in this chapter) may induce hyperventilation, resulting in decreased SCBA operating time [8].

Suit/Ensemble Permeation and Penetration

The possibility of chemical permeation or penetration of CPC ensembles during the work mission is always a matter of concern and may limit mission duration. Possible causes of ensemble penetration are:

- Suit valve leakage, particularly under excessively hot or cold temperatures.
- Suit fastener leakage if the suit is not properly maintained or if the fasteners become brittle at cold temperatures.

- Exhalation valve leakage at excessively hot or cold temperatures.

Also, when considering mission duration, it should be remembered that no single clothing material is an effective barrier to all chemicals or all combinations of chemicals, and no material is an effective barrier to prolonged chemical exposure.

Ambient Temperature

The ambient temperature has a major influence on work mission duration as it affects both the worker and the protective integrity of the ensemble. Heat stress, which can occur even in relatively moderate temperatures, is the greatest immediate danger to an ensemble-encapsulated worker. Methods to monitor for and prevent heat stress are discussed in the final section of this chapter, *Heat Stress and Other Physiological Factors*. Hot and cold ambient temperatures also affect:

- Valve operation on suits and/or respirators.
- The durability and flexibility of suit materials.
- The integrity of suit fasteners.
- The breakthrough time and permeation rates of chemicals.
- The concentration of airborne contaminants.

All these factors may decrease the duration of protection provided by a given piece of clothing or respiratory equipment.

Coolant Supply

Under warm or strenuous work conditions, adequate coolant (ice or chilled air, see Table 8-5) should be provided to keep the wearer's body at a comfortable temperature and to reduce the potential for heat stress (see *Heat Stress and Other Physiological Factors* at the end of this chapter). If coolant is necessary, the duration of the coolant supply will directly affect mission duration.

Personal Use Factors

As described below, certain personal features of workers may jeopardize safety during equipment use. Prohibitive or precautionary measures should be taken as necessary.

Facial hair and long hair interfere with respirator fit and wearer vision. Any facial hair that passes between the face and the sealing surface of the respirator should be prohibited. Even a few days' growth of facial hair will allow excessive contaminant penetration. Long hair must be effectively contained within protective hair coverings. Eyeglasses with conventional temple pieces (earpiece bars) will interfere with the respirator-to-face seal of a full facepiece. A spectacle kit should be installed in the face masks of workers requiring vision correction.

When a worker must wear corrective lenses as part of the facepiece, the lenses shall be fitted by qualified individuals to provide good vision, comfort, and a gastight seal. Contact lenses may trap contaminants and/or particulates between the lens and the eye, causing irritation, damage, absorption, and an urge to remove the respirator. Wearing contact lenses with a respirator in a contaminated atmosphere is prohibited (29 CFR Part 1910.134[e][51][ii]).

Gum and tobacco chewing should be prohibited during respirator use since they may cause ingestion of contaminants and may compromise the respirator fit.

Donning an Ensemble

A routine should be established and practiced periodically for donning a fully-encapsulating suit/SCBA ensemble. Assistance should be provided for donning and doffing since these operations are difficult to perform alone, and solo efforts may increase the possibility of suit damage.

Table 8-7 lists sample procedures for donning a fully encapsulating suit/SCBA ensemble. These procedures should be modified depending on the particular type of suit and/or when extra gloves and/or boots are used. These procedures assume that the wearer has previous training in SCBA use and decontamination procedures.

Once the equipment has been donned, its fit should be evaluated. If the clothing is too small, it will restrict movement, thereby increasing the likelihood of tearing the suit material and accelerating worker fatigue. If the clothing is too large, the possibility of snagging the material is increased, and the dexterity and coordination of the worker may be compromised. In either case, the worker should be recalled and better fitting clothing provided.



As part of donning operations, an assistant tape seals boots to protective clothing to eliminate routes of entry for chemicals.

Respirator Fit Testing

The "fit" or integrity of the facepiece-to-face seal of a respirator affects its performance. A secure fit is important with positive-pressure equipment, and is essential to the safe functioning of negative-pressure equipment, such as most air-purifying respirators. Most facepieces fit only a certain percentage of the population; thus each facepiece must be tested on the potential wearer in order to ensure a tight seal. Facial features such as scars, hollow temples, very prominent cheekbones, deep skin creases, dentures or missing teeth, and the chewing of gum and tobacco may interfere with the respirator-to-face seal. A respirator shall not be worn when such conditions prevent a good seal. The workers' diligence in observing these factors shall be evaluated by periodic checks.

For a qualitative respirator fit testing protocol, see Appendix D of the OSHA lead standard (29 CFR Part 1910.1025). For quantitative fit testing, see the NIOSH publication *A Guide to Industrial Respiratory Protection* [10]. For specific quantitative testing protocols, literature supplied by manufacturers of quantitative fit test equipment should be consulted. Note that certain OSHA standards require quantitative fit testing under specific circumstances (e.g., 29 CFR Parts 1910.1018[h][3][iii], 1910.1025[f][3][ii], and 1910.1045[h][3][iii][B]).

Table 8-7. Sample Donning Procedures^{a,b,c}

1. Inspect the clothing and respiratory equipment before donning (see *Inspection*).
2. Adjust hard hat or headpiece if worn, to fit user's head.
3. Open back closure used to change air tank (if suit has one) before donning suit.
4. Standing or sitting, step into the legs of the suit; ensure proper placement of the feet within the suit; then gather the suit around the waist.
5. Put on chemical-resistant safety boots over the feet of the suit. Tape the leg cuff over the tops of the boots.
 - If additional chemical-resistant boots are required, put these on now.
 - Some one-piece suits have heavy-soled protective feet. With these suits, wear short, chemical-resistant safety boots inside the suit.
6. Put on air tanks and harness assembly of the SCBA. Don the facepiece and adjust it to be secure, but comfortable. Do *not* connect the breathing hose. Open valve on air tank.
7. Perform negative and positive respirator facepiece seal test procedures.
 - To conduct a negative-pressure test, close the inlet part with the palm of the hand or squeeze the breathing tube so it does not pass air, and gently inhale for about 10 seconds. Any inward rushing of air indicates a poor fit. Note that a leaking facepiece may be drawn tightly to the face to form a good seal, giving a false indication of adequate fit.
 - To conduct a positive-pressure test, gently exhale while covering the exhalation valve to ensure that a positive pressure can be built up. Failure to build a positive pressure indicates a poor fit.
8. Depending on type of suit:
 - Put on long-sleeved inner gloves (similar to surgical gloves).
 - Secure gloves to sleeves, for suits with detachable gloves (if not done prior to entering the suit).
 - Additional overgloves, worn over attached suit gloves, may be donned later.
9. Put sleeves of suit over arms as assistant pulls suit up and over the SCBA. Have assistant adjust suit around SCBA and shoulders to ensure unrestricted motion.
10. Put on hard hat, if needed.
11. Raise hood over head carefully so as not to disrupt face seal of SCBA mask. Adjust hood to give satisfactory comfort.
12. Begin to secure the suit by closing all fasteners on opening until there is only adequate room to connect the breathing hose. Secure all belts and/or adjustable leg, head, and waistbands.
13. Connect the breathing hose while opening the main valve.
14. Have assistant first ensure that wearer is breathing properly and then make final closure of the suit.
15. Have assistant check all closures.
16. Have assistant observe the wearer for a period of time to ensure that the wearer is comfortable, psychologically stable, and that the equipment is functioning properly.

^aSource: Based on reference [9].

^bPerform the procedures in the order indicated.

^cWhen donning a suit, use a moderate amount of a powder to prevent chafing and to increase comfort. Powder will also reduce rubber binding.

In-Use Monitoring

The wearer must understand all aspects of the clothing operation and its limitations; this is especially important for fully-encapsulating ensembles where misuse could potentially result in suffocation.

During equipment use, workers should be encouraged to report any perceived problems or difficulties to their supervisors). These malfunctions include, but are not limited to:

- Degradation of the protective ensemble.
- Perception of odors.
- Skin irritation.
- Unusual residues on PPE.
- Discomfort.
- Resistance to breathing.
- Fatigue due to respirator use.
- Interference with vision or communication.
- Restriction of movement.
- Personal responses such as rapid pulse, nausea, and chest pain.

If a supplied-air respirator is being used, all hazards that might endanger the integrity of the air line should be removed from the working area prior to use. During use, air lines should be kept as short as possible and other workers and vehicles should be excluded from the area.

Doffing an Ensemble

Exact procedures for removing fully-encapsulating suit/SCBA ensembles must be established and followed in order to prevent contaminant migration from the work area and transfer of contaminants to the wearer's body, the doffing assistant, and others.

Sample doffing procedures are provided in Table 8-8. These procedures should be performed only after decontamination of the suited worker (see Chapter 10, *Decontamination*). They require a suitably attired assistant. Throughout the procedures, both worker and assistant should avoid any direct contact with the outside surface of the suit.

Clothing Reuse

Chemicals that have begun to permeate clothing during use may not be removed during decontamination and may continue to diffuse through the material towards the inside surface, presenting the hazard of direct skin contact to the next person who uses the clothing.

Where such potential hazards may develop, clothing should be checked inside and out for discoloration or other evidence of contamination (see next section, *Inspection*). This is particularly important for fully encapsulating suits, which are generally subject to reuse due to their cost. Note, however, that negative (i.e., no chemical found) test results do not necessarily preclude the possibility that some absorbed chemical will reach the suit's interior.

At present, little documentation exists regarding clothing reuse. Reuse decisions must consider the known factors of permeation rates as well as the toxicity of the contaminant(s). In fact, unless extreme care is taken to ensure that clothing is properly decontaminated and that the decontamination does not degrade the material, the reuse of chemical protective clothing that has been contaminated with toxic chemicals is not advisable [4].

Table 8-8. Sample Doffing Procedures^a

If sufficient air supply is available to allow appropriate decontamination before removal:

1. Remove any extraneous or disposable clothing, boot covers, outer gloves, and tape.
2. Have assistant loosen and remove the wearer's safety shoes or boots.
3. Have assistant open the suit completely and lift the hood over the head of the wearer and rest it on top of the SCBA tank.
4. Remove arms, one at a time, from suit. Once arms are free, have assistant lift the suit up and away from the SCBA backpack—avoiding any contact between the outside surface of the suit and the wearer's body—and lay the suit out flat behind the wearer. Leave internal gloves on, if any.
5. Sitting, if possible, remove both legs from the suit.
6. Follow procedure for doffing SCBA.
7. After suit is removed, remove internal gloves by rolling them off the hand, inside out.
8. Remove internal clothing and thoroughly cleanse the body.

If the low-pressure warning alarm has sounded, signifying that approximately 5 minutes of air remain:

1. Remove disposable clothing.
2. Quickly scrub and hose off, especially around the entrance/exit zipper.
3. Open the zipper enough to allow access to the regulator and breathing hose.
4. Immediately attach an appropriate canister to the breathing hose (the type and fittings should be predetermined). Although this provides some protection against any contamination still present, it voids the certification of the unit.

Follow Steps 1 through 8 of the regular doffing procedure above. Take extra care to avoid contaminating the assistant and wearer.

^aSource = Based on reference [9].

Inspection

An effective PPE inspection program will probably feature five different inspections:

- Inspection and operational testing of equipment received from the factory or distributor.
- Inspection of equipment as it is issued to workers.
- Inspection after use or training and prior to maintenance.
- Periodic inspection of stored equipment.
- Periodic inspection when a question arises concerning the appropriateness of the selected equipment, or when problems with similar equipment arise.

Each inspection will cover somewhat different areas in varying degrees of depth. Detailed inspection procedures, where appropriate, are usually available from the manufacturer. The inspection checklists provided in Table 8-9 may also be an aid.

Records must be kept of all inspection procedures. Individual identification numbers should be assigned to all reusable pieces of equipment (respirators may already have ID numbers) and records should be maintained by that number. At a minimum, each inspection should record the ID number, date, inspector, and any unusual conditions or findings. Periodic review of these records may indicate an item or type of item with excessive maintenance costs or a particularly high level of "down-time."

Table 8-9. Sample PPE Inspection Checklists

CLOTHING

Before use:

- Determine that the clothing material is correct for the specified task at hand.
- Visually inspect for:
 - Imperfect seams
 - non-uniform coatings
 - tears
 - malfunctioning closures
- Hold up to light and check for pinholes.
- Flex product:
 - observe for cracks
 - observe for other signs of shelf deterioration
- If the product has been used previously, inspect inside and out for signs of chemical attack:
 - discoloration
 - swelling
 - stiffness

During the work task, periodically inspect for:

- Evidence of chemical attack such as discoloration, swelling, stiffening, and softening. Keep in mind, however, that chemical permeation can occur without any visible effects.
- Closure failure.
- Tears.
- Puncture.
- Seam discontinuities.

GLOVES

- **BEFORE USE**, pressurize glove to check for pinholes. Either blow into glove, then roll gauntlet towards fingers or inflate glove and hold under water. In either case, no air should escape.

FULLY-ENCAPSULATING SUITS

Before use:

- Check the operation of pressure relief valves.
- Inspect the fitting of wrists, ankles, and neck
- Check faceshield, if so equipped, for:
 - cracks
 - crazing
 - fogginess

RESPIRATORS

SCBA

- Inspect SCBAs:
 - before and after each use
 - at least monthly when in storage
 - every time they are cleaned
- Check all connections for tightness.
- Check material conditions for:
 - signs of pliability
 - signs of deterioration
 - signs of distortion
- Check for proper setting and operation of regulators and valves (according to manufacturers' recommendations).
- Check operation of alarm(s).
- Check faceshields and lenses for:
 - cracks
 - crazing
 - fogginess

Supplied-Air Respirators

- Inspect SARs:
 - daily when in use
 - at least monthly when in storage
 - every time they are cleaned
- Inspect air lines prior to each use for cracks, kinks, cuts, frays, and weak areas.
- Check for proper setting and operation of regulators and valves (according to manufacturers' recommendations).
- Check all connections for tightness.
- Check material conditions for:
 - signs of pliability
 - signs of deterioration
 - signs of distortion
- Check faceshields and lenses for:
 - cracks
 - crazing
 - fogginess

Air-Purifying Respirators

- Inspect air-purifying respirators:
 - before each use to be sure they have been adequately cleaned
 - after each use
 - during cleaning
 - monthly if in storage for emergency use
- Check material conditions for:
 - signs of pliability
 - signs of deterioration
 - signs of distortion
- Examine cartridges or canisters to ensure that:
 - they are the proper type for the intended use
 - the expiration date has not been passed
 - they have not been opened or used previously
- Check faceshields and lenses for:
 - cracks
 - crazing and fogginess

Storage

Clothing and respirators must be stored properly to prevent damage or malfunction due to exposure to dust, moisture, sunlight, damaging chemicals, extreme temperatures, and impact. Procedures must be specified for both pre-issuance warehousing and, more importantly, postissuance (in-use) storage. Many equipment failures can be directly attributed to improper storage.

Clothing:

- Potentially contaminated clothing should be stored in an area separate from street clothing.
- Potentially contaminated clothing should be stored in a well-ventilated area, with good air flow around each item, if possible.
- Different types and materials of clothing and gloves should be stored separately to prevent issuing the wrong material by mistake.
- Protective clothing should be folded or hung in accordance with manufacturers' recommendations.

Respirators:

- SCBAs, supplied-air respirators, and air-purifying respirators should be dismantled, washed, and disinfected after each use.
- SCBAs should be stored in storage chests supplied by the manufacturer. Air-purifying respirators should be stored individually in their original cartons or carrying cases, or in heat-sealed or resealable plastic bags.

Maintenance

The technical depth of maintenance procedures vary. Manufacturers frequently restrict the sale of certain PPE parts to individuals or groups who are specially trained, equipped, and "authorized" by the manufacturer to purchase them.

Explicit procedures should be adopted to ensure that the appropriate level of maintenance is performed only by individuals having this specialized training and equipment. The following classification scheme is often used to divide maintenance into three levels:

- Level 1: User or wearer maintenance, requiring a few common tools or no tools at all.
- Level 2: Shop maintenance that can be performed by the employer's maintenance shop.
- Level 3: Specialized maintenance that can be performed only by the factory or an authorized repair person.

Heat Stress and Other Physiological Factors

Wearing PPE puts a hazardous waste worker at considerable risk of developing heat stress. This can result in health effects ranging from transient heat fatigue to serious illness or death. Heat stress is caused by a number of interacting factors, including environmental conditions, clothing, workload, and the individual characteristics of the worker. Because heat stress is probably one of the most common (and potentially serious) illnesses at hazardous waste sites, regular monitoring and other preventive precautions are vital.

Individuals vary in their susceptibility to heat stress. Factors that may predispose someone to heat stress include:

- Lack of physical fitness.
- Lack of acclimatization.
- Age.
- Dehydration.
- Obesity.
- Alcohol and drug use.
- Infection.
- Sunburn.
- Diarrhea.
- Chronic disease.

Reduced work tolerance and the increased risk of excessive heat stress is directly influenced by the amount and type of PPE worn. PPE adds weight and bulk, severely reduces the body's access to normal heat exchange mechanisms (evaporation, convection, and radiation), and increases energy expenditure. Therefore, when selecting PPE, each item's benefit should be carefully evaluated in relation to its potential for increasing the risk of heat stress. Once PPE is selected, the safe duration of work/rest periods should be determined based on the:

- Anticipated work rate.
- Ambient temperature and other environmental factors.
- Type of protective ensemble.
- Individual worker characteristics and fitness.

Monitoring

Because the incidence of heat stress depends on a variety of factors, all workers, even those not wearing protective equipment, should be monitored.

- For workers wearing permeable clothing (e.g., standard cotton or synthetic work clothes), follow recommendations for monitoring requirements and suggested work/rest schedules in the current American Conference of Governmental Industrial Hygienists' (ACGIH) Threshold Limit Values for Heat Stress [11]. If the actual clothing worn differs from the ACGIH standard ensemble in insulation value and/or wind and vapor permeability, change the monitoring requirements and work/rest schedules accordingly [12].
- For workers wearing semi-permeable or impermeable¹ encapsulating ensembles, the ACGIH standard cannot be used. For these situations, workers should be monitored when the temperature in the work area is above 70°F (21°C) [6].

To monitor the worker, measure:

- Heart rate. Count the radial pulse during a 30-second period as early as possible in the rest period.
 - If the heart rate exceeds 110 beats per minute at the beginning of the rest period, shorten the next work cycle by one-third and keep the rest period the same.
 - If the heart rate still exceeds 110 beats per minute at the next rest period, shorten the following work cycle by one-third [12].
- Oral temperature. Use a clinical thermometer (3 minutes under the tongue) or similar device to measure the oral temperature at the end of the work period (before drinking).

¹ Although no protective ensemble is "completely" impermeable, for practical purposes an outfit may be considered impermeable when calculating heat stress risk

- If oral temperature exceeds 99.6°F (37.6°C), shorten the next work cycle by one-third without changing the rest period.
- If oral temperature still exceeds 99.6°F (37.6°C) at the beginning of the next rest period, shorten the following work cycle by one-third [12].
- Do *not* permit a worker to wear a semi-permeable or impermeable garment when his/her oral temperature exceeds 100.6 °F (38.1 °C)[12].
- Body water loss, if possible. Measure weight on a scale accurate to ±0.25 lb at the beginning and end of each work day to see if enough fluids are being taken to prevent dehydration. Weights should be taken while the employee wears similar clothing or, ideally, is nude. The body water loss should not exceed 1.5 percent total body weight loss in a work day [12].

Initially, the frequency of physiological monitoring depends on the air temperature adjusted for solar radiation and the level of physical work (see Table 8-10). The length of the work cycle will be governed by the frequency of the required physiological monitoring.

Table 8-10. Suggested Frequency of Physiological Monitoring for Fit and Acclimatized Workers^a

| ADJUSTED TEMPERATURE ^b | NORMAL WORK ENSEMBLE ^c | IMPERMEABLE ENSEMBLE |
|-----------------------------------|-----------------------------------|--------------------------------|
| 90°F (32.2°C) or above | After each 45 minutes of work | After each 15 minutes of work |
| 87.5°-90°F (30.8°-32.2°C) | After each 60 minutes of work | After each 30 minutes of work |
| 82.5°-87.5°F (28.1°-30.8°C) | After each 90 minutes of work | After each 60 minutes of work |
| 77.5°-82.5°F (25.3°-28.1°C) | After each 120 minutes of work | After each 90 minutes of work |
| 72.5°-77.5°F (22.5°-25.3°) | After each 150 minutes of work | After each 120 minutes of work |

Source: Reference [13].

^aFor work levels of 250 kilocalories/hour.

^bCalculate the adjusted air temperature (ta adj) by using this equation: $ta\ adj\ ^\circ F = ta\ ^\circ F + (13 \times \% \text{ sunshine})$. Measure the air temperature (ta) with a standard mercury-in-glass thermometer, with the bulb shielded from radiant heat. Estimate the percent sunshine by judging what percent time the sun is not covered by clouds that are thick enough to produce a shadow. (100 percent sunshine = no cloud cover and a sharp, distinct shadow; 0 percent sunshine = no shadows.)

^cA normal work ensemble consists of cotton coveralls or other cotton clothing with long sleeves and pants.

Prevention

Proper training and preventive measures will help avert serious illness and loss of work productivity. Preventing heat stress is particularly important because once someone suffers from heat stroke or heat exhaustion, that person may be predisposed to additional heat injuries. To avoid heat stress, management should take the following steps:

- Adjust work schedules:
 - Modify work/rest schedules according to monitoring requirements.
 - Mandate work slowdowns as needed.

- Rotate personnel: alternate job functions to minimize overstress or overexertion at one task.
- Add additional personnel to work teams.
- Perform work during cooler hours of the day if possible or at night if adequate lighting can be provided.
- Provide shelter (air-conditioned, if possible) or shaded areas to protect personnel during rest periods.
- Maintain workers' body fluids at normal levels. This is necessary to ensure that the cardiovascular system functions adequately. Daily fluid intake must approximately equal the amount of water lost in sweat, i.e., 8 fluid ounces (0.23 liters) of water must be ingested for approximately every 8 ounces (0.23 kg) of weight lost. The normal thirst mechanism is not sensitive enough to ensure that enough water will be drunk to replace lost sweat [141]. When heavy sweating occurs, encourage the worker to drink more. The following strategies may be useful:
 - Maintain water temperature at 50° to 60 °F (10° to 15.6°C).
 - Provide small disposable cups that hold about 4 ounces (0.1 liter).
 - Have workers drink 16 ounces (0.5 liters) of fluid (preferably water or dilute drinks) before beginning work.
 - Urge workers to drink a cup or two every 15 to 20 minutes, or at each monitoring break. A total of 1 to 1.6 gallons (4 to 6 liters) of fluid per day are recommended, but more may be necessary to maintain body weight.
 - Weigh workers before and after work to determine if fluid replacement is adequate.
- Encourage workers to maintain an optimal level of physical fitness:
 - Where indicated, acclimatize workers to site work conditions: temperature, protective clothing, and workload (see Level of Acclimatization at the end of this chapter).
 - Urge workers to maintain normal weight levels.
- Provide cooling devices to aid natural body heat exchange during prolonged work or severe heat exposure. Cooling devices include:
 - Field showers or hose-down areas to reduce body temperature and/or to cool off protective clothing.
 - Cooling jackets, vests, or suits (see Table 8-5 for details).
- Train workers to recognize and treat heat stress. As part of training, identify the signs and symptoms of heat stress (see Table 8-11).

Other Factors

PPE decreases worker performance as compared to an unequipped individual. The magnitude of this effect varies considerably, depending on both the individual and the PPE ensemble used. This section discusses the demonstrated physiological responses to PPE, the individual human characteristics that play a factor in these responses, and some of the precautionary and training measures that need to be taken to avoid PPE-induced injury.

The physiological factors may affect worker ability to function using PPE include:

- Physical condition.
- Level of acclimatization.
- Age.
- Gender.
- Weight.

Table 8-11. Signs and Symptoms of Heat Stress^a

- **Heat rash** may result from continuous exposure to heat or humid air.
- **Heat cramps** are caused by heavy sweating with inadequate electrolyte replacement. Signs and symptoms include:
 - Muscle spasms
 - pain in the hands, feet, and abdomen
- **Heat exhaustion** occurs from increased stress on various body organs including inadequate blood circulation due to cardiovascular insufficiency or dehydration. Signs and symptoms include:
 - Pale, cool, moist skin
 - Heavy sweating
 - Dizziness
 - Nausea
 - Fainting
- **Heat stroke** is the most serious form of heat stress. Temperature regulation fails and the body temperature rises to critical levels. Immediate action must be taken to cool the body before serious injury and death occur. Competent medical help must be obtained. Signs and symptoms are:
 - Red, hot, usually dry skin
 - Lack of or reduced perspiration
 - Nausea, dizziness and confusion
 - Strong, rapid pulse, and coma

^aSource: Reference [6].

Physical Condition

Physical fitness is a major factor influencing a person's ability to perform work under heat stress. The more fit someone is, the more work they can safely perform. At a given level of work, a fit person, relative to an unfit person, will have [5,8,15,16]:

- Less physiological strain.
- A lower heart rate.
- A lower body temperature, which indicates less retained body heat (a rise in internal temperature precipitates heat injury).
- A more efficient sweating mechanism.
- Slightly lower oxygen consumption.
- Slightly lower carbon dioxide production.

Level of Acclimatization

The degree to which a worker's body has physiologically adjusted or acclimatized to working under hot conditions affects his or her ability to do work. Acclimatized individuals generally have lower heart rates and body temperatures than unacclimatized individuals [17], and sweat sooner and more profusely. This enables them to maintain lower skin and body temperatures at a given level of environmental heat and work loads than unacclimatized workers [18]. Sweat composition also becomes more dilute with acclimatization, which reduces salt loss [8].

Acclimatization can occur after just a few days of exposure to a hot environment [15,16]. NIOSH recommends a progressive 6-day acclimatization period for the unacclimatized worker before allowing him/her to do full work on a hot job [16]. Under this regimen, the first day of work on site

is begun using only 50 percent of the anticipated workload and exposure time, and 10 percent is added each day through day 6 [16]. With fit or trained individuals, the acclimatization period may be shortened 2 or 3 days. However, workers can lose acclimatization in a matter of days, and work regimens should be adjusted to account for this.

When enclosed in an impermeable suit, fit acclimatized individuals sweat more profusely than unfit or unacclimatized individuals and may therefore actually face a greater danger of heat exhaustion due to rapid dehydration. This can be prevented by consuming adequate quantities of water. See previous section on *Prevention* for additional information.

Age

Generally, maximum work capacity declines with increasing age, but this is not always the case. Active, well-conditioned seniors often have performance capabilities equal to or greater than young sedentary individuals. However, there is some evidence, indicated by lower sweat rates and higher body core temperatures, that older individuals are less effective in compensating for a given level of environmental heat and work loads [19]. At moderate thermal loads, however, the physiological responses of "young" and "old" are similar and performance is not affected [19].

Age should not be the sole criterion for judging whether or not an individual should be subjected to moderate heat stress. Fitness level is a more important factor.

Gender

The literature indicates that females tolerate heat stress at least as well as their male counterparts [20]. Generally, a female's work capacity averages 10 to 30 percent less than that of a male [8]. The primary reasons for this are the greater oxygen-carrying capacity and the stronger heart in the male [15]. However, a similar situation exists as with aging: not all males have greater work capacities than all females.

Weight

The ability of a body to dissipate heat depends on the ratio of its surface area to its mass (surface area/weight). Heat loss (dissipation) is a function of surface area and heat production is dependent on mass. Therefore, heat balance is described by the ratio of the two.

Since overweight individuals (those with a low ratio) produce more heat per unit of surface area than thin individuals (those with a high ratio), overweight individuals should be given special consideration in heat stress situations. However, when wearing impermeable clothing, the weight of an individual is not a critical factor in determining the ability to dissipate excess heat.

References

1. NIOSH. 1985. Certified Equipment List as of October 1, 1984. DHHS (NIOSH) No. 85-101. National Institute for Occupational Safety and Health, Cincinnati, OH. Updated annually.
2. Moyer, E.S. 1983. Review of influential factors affecting the performance of organic vapor airpurifying respirator cartridges. J. Am. Ind. Hyg. Assoc. 44:46-51.
3. MSHA/NIOSH. Canister bench tests; minimum requirements. 30 CFR Part 11.102-5.

4. Schwope, A.D.; Costas, P.R; Jackson, J.O.; and D.J. Weitzman. 1985. Guidelines for the Selection of Chemical-Protective Clothing, Second Edition. American Conference of Governmental Industrial Hygienists, Inc. 6500 Lynnway Avenue, Building D-7, Cincinnati, OH 45211.
5. Goldman, R.F. 1970. Tactical Implications of the Physiological Stress Imposed by Chemical Protective Clothing Systems. Army Science Conference, Natick, MA.
6. U.S. EPA. 1984. Standard Operating Safety Guides. Office of Emergency and Remedial Response, Hazardous Response Support Division, Edison, NJ. November, 1984.
7. Home Office. 1974. Breathing Apparatus and Resuscitation. Book IV of Manual of Firemanship. London, England.
8. McArdle, W.D.; Katch, F.I.; and V.L. Katch. 1981. Exercise Physiology: Energy, Nutrition, and Human Performance. Lea and Febiger, Philadelphia, PA.
9. U.S. EPA, Office of Emergency and Remedial Response, Hazardous Response Support Division. 1985. Field Standard Operating Procedures for Site Entry, FSOP #4.
10. NIOSH. 1976. A Guide to Industrial Respiratory Protection. NIOSH (DHEW) 76-189. Cincinnati, OH.
11. American Conference of Governmental Industrial Hygienists. 1985. Threshold Limit Values for Chemical Substances and Physical Agents in the Workplace Environment and Biological Exposure Indices with Intended Changes for 1985-86. Cincinnati, OH.
12. NIOSH. 1981. Chemical Control Corporation, Elizabeth New Jersey. Hazard Evaluation Report. TA-80-77-853.
13. Henschel, A. 1985. Memorandum to Sheldon Rabinovitz from Austin Henschel, NIOSH, Cincinnati, OH. June 20, 1985.
14. Goldman, R.F. 1983. Heat Stress in Industrial Protective Encapsulating Garments. Contract deliverable to U.S. Department of Health and Human Services, Order No. 83-211.
15. Dukes-Dubos, F.N. and A. Henschel, eds. 1980. Proceedings of a NIOSH Workshop on Recommended Heat Stress Standards. U.S. Department of Health and Human Services, Cincinnati, OH. p. 153.
16. Ramsey, J.D. 1976. NIOSH, Standards Advisory Committee on Heat Stress-Recommended Standard for Work in Hot Environments. Appendix C in Standards for Occupational Exposure to Hot Environments, proceedings of symposium, Cincinnati, OH.
17. Astrand, I.; Axelson, O.; Eriksson, U.; and L. Olander. 1975. Heat stress in occupational work. *Ambio* 4:37-42.
18. Eichna, L.W.; Park, C.R.; Nelson, N.; Horvath, S.M.; and E.D. Palmes. 1950. Thermal regulation during acclimatization in a hot, dry (desert type) environment. *Am. J. Physiol.* 163:585-597.
19. Lind, A.R.; Humphreys, P.W.; Collins, K.J.; Foster, K.; and K.F. Sweetland. 1970. Influence of age and daily duration of exposure on responses of men to work in heat. *J. Appl. Physiol.* 28:50-56.
20. Shapiro, Y.; Pandolf, K.B.; Avellini, B.A.; Pimental, N.A.; and R.F. Goldman. 1981. Heat balance and heat transfer in men and women exercising in hot-dry and hot-wet conditions. *Ergonomics* 24:375-386.

9. Site Control

Contents

| | |
|------------------------------|------|
| Introduction | 9-1 |
| Site Map | 9-2 |
| Site Preparation | 9-2 |
| Site Work Zones | 9-2 |
| Exclusion Zone | 9-3 |
| Contamination Reduction Zone | 9-4 |
| Support Zone | 9-6 |
| The Buddy System | 9-8 |
| Site Security | 9-8 |
| Communication Systems | 9-9 |
| Safe Work Practices | 9-10 |
| References | 9-12 |

Introduction

The purpose of site control is to minimize potential contamination of workers, protect the public from the site's hazards, and prevent vandalism. Site control is especially important in emergency situations. This chapter describes the basic components of a program to control the activities and movements of people and equipment at a hazardous waste site.

Several site control procedures can be implemented to reduce worker and public exposure to chemical, physical, biologic, and safety hazards:

- Compile a site map.
- Prepare the site for subsequent activities.
- Establish work zones.
- Use the buddy system when necessary.
- Establish and strictly enforce decontamination procedures for both personnel and equipment (see Chapter 10, *Decontamination*).
- Establish site security measures.
- Set up communication networks.
- Enforce safe work practices.

This chapter, based on EPA's *Standard Operating Safety Guides* [1], discusses general aspects of these eight control measures.

The degree of site control necessary depends on site characteristics, site size, and the surrounding community. The site control program should be established in the planning stages of a project and modified based on new information and site assessments (see Chapter 6, *Site Characterization*). The appropriate sequence for implementing these measures should be determined on a site specific basis. In many cases, it will be necessary to implement several measures simultaneously.

Site Map

A site map showing topographic features, prevailing wind direction, drainage, and the location of buildings, containers, impoundments, pits, ponds, and tanks is helpful in:

- Planning activities.
- Assigning personnel.
- Identifying access routes, evacuation routes, and problem areas.
- Identifying areas of the site that require use of personal protective equipment.
- Supplementing the daily safety and health briefings of the field teams.

The map should be prepared prior to site entry and updated throughout the course of site operations to reflect:

- Accidents.
- Changes in site activities.
- Emergencies.
- Hazards not previously identified.
- New materials introduced on site.
- Vandalism.
- Weather conditions.

Overlays can be used to help portray information without cluttering the map.

Site Preparation

Time and effort must be spent in preparing a site for the cleanup activity to ensure that response operations go smoothly and that worker safety is protected. Site preparation can be as hazardous as site cleanup. Therefore, safety measures should be afforded the same level of care at this stage as during actual cleanup. Table 9-1 presents the major steps in site preparation prior to any cleanup activities.

Site Work Zones

To reduce the accidental spread of hazardous substances by workers from the contaminated area to the clean area, zones should be delineated on the site where different types of operations will occur, and the flow of personnel among the zones should be controlled. The establishment of work zones will help ensure that: personnel are properly protected against the hazards present where they are working, work activities and contamination are confined to the appropriate areas, and personnel can be located and evacuated in an emergency.

Hazardous waste sites should be divided into as many different zones as needed to meet operational and safety objectives. For illustration, this manual describes three frequently used zones:

- *Exclusion Zone*, the contaminated area.
- *Contamination Reduction Zone (CRZ)*, the area where decontamination takes place.
- *Support Zone*, the uncontaminated area where workers should not be exposed to hazardous conditions.

Delineation of these three zones should be based on sampling and monitoring results and on an evaluation of potential routes and amount of contaminant dispersion in the event of a release. Movement

of personnel and equipment among these zones should be minimized and restricted to specific Access Control Points to prevent cross-contamination from contaminated areas to clean areas. A schematic representation of the layout of work zones is given in Figure 9-1.

Table 9-1. Site Preparation

- Construct roadways to provide ease of access and a sound roadbed for heavy equipment and vehicles.
- Arrange traffic flow patterns to ensure safe and efficient operations.
- Eliminate physical hazards from the work area as much as possible, including:
 - ignition sources in flammable hazard areas.
 - exposed or ungrounded electrical wiring, and low overhead wiring that may entangle equipment.
 - sharp or protruding edges, such as glass, nails, and torn metal, which can puncture protective clothing and equipment and inflict puncture wounds.
 - debris, holes, loose steps or flooring, protruding objects, slippery surfaces, or unsecured railings, which can cause falls, slips, and trips.
 - unsecured objects, such as bricks and gas cylinders, near the edges of elevated surfaces, such as catwalks, roof tops, and scaffolding, which may dislodge and fall on workers.
 - debris and weeds that obstruct visibility.
- Install skid-resistant strips and other anti-skid devices on slippery surfaces.
- Construct operation pads for mobile facilities and temporary structures.
- Construct loading docks, processing and staging areas, and decontamination pads.
- Provide adequate illumination for work activities. Equip temporary lights with guards to prevent accidental contact.
- Install all wiring and electrical equipment in accordance with the National Electric Code.

Exclusion Zone

The Exclusion Zone is the area where contamination does or could occur. The primary activities performed in the Exclusion Zone are:

- Site characterization, such as mapping, photographing, and sampling.
 - Installation of wells for groundwater monitoring.
- Cleanup work, such as drum movement, drum staging, and materials bulking.

The outer boundary of the Exclusion Zone, called the Hotline, should be established according to the criteria listed in Table 9-2. It should be clearly marked by lines, placards, hazard tape and/or signs; or enclosed by physical barriers, such as chains, fences, or ropes. Access Control Points should be established at the periphery of the Exclusion Zone to regulate the flow of personnel and equipment into and out of the zone and to help verify that proper procedures for entering and exiting are followed. If feasible, separate entrances and exits should be established to separate personnel and equipment movement into and out of the Exclusion Zone.

The Exclusion Zone can be subdivided into different areas of contamination based on the known or expected type and degree of hazard or on the incompatibility of waste streams. This allows more flexibility in safety requirements, operations, decontamination procedures, and use of resources.

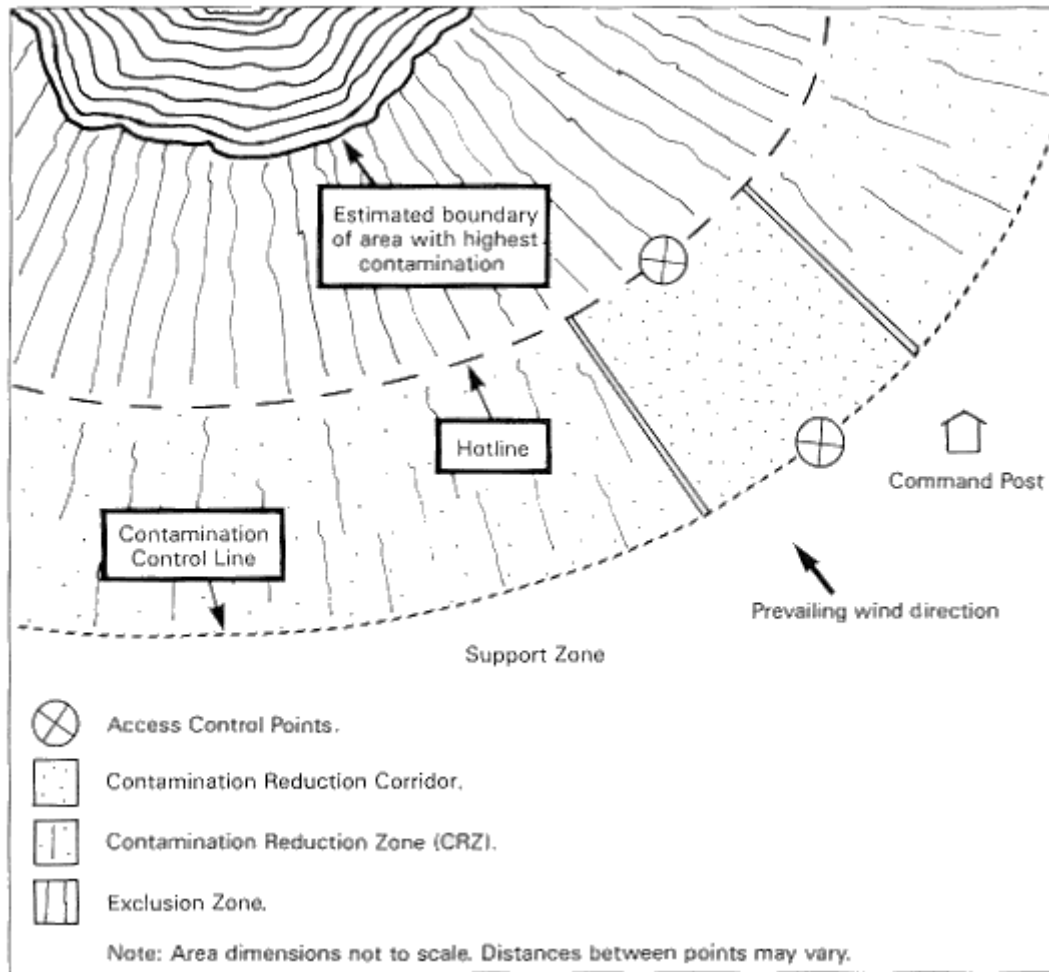

Figure 9-1. Site Work Zones. (Note that decontamination facilities are located in the Contamination Reduction Zone.)

The personnel working in the Exclusion Zone may include the Field Team Leader, the work parties, and specialized personnel such as heavy equipment operators. All personnel within the Exclusion Zone should wear the level of protection required by the Site Safety Plan. Within the zone, different levels of protection may be justified based on the degree of hazard presented. The level of personal protection required in each subarea (see Chapter 8, *Personal Protective Equipment*) should be specified and marked.

The required level of protection in the Exclusion Zone varies according to job assignment. For example, a worker who collects samples from open containers might require Level B protection, while one that performs walk-through ambient air monitoring might only need Level C protection. When appropriate, different levels of protection within the Exclusion Zone should be assigned to promote a more flexible, effective, and less costly operation, while still maintaining a high degree of safety.

Contamination Reduction Zone

The Contamination Reduction Zone (CRZ) is the transition area between the contaminated area and the clean area. This zone is designed to reduce the probability that the clean Support Zone will become contaminated or affected by other site hazards. The distance between the Exclusion and Support Zones provided by the CRZ, together with decontamination of workers and equipment, limits the physical

transfer of hazardous substances into clean areas. The boundary between the CRZ and the Exclusion Zone is called the Hotline. The degree of contamination in the CRZ decreases as one moves from the Hotline to the Support Zone, due both to the distance and the decontamination procedures.

Decontamination procedures take place in a designated area within the CRZ called the Contamination Reduction Corridor (CRC). They begin at the Hotline. At least two lines of decontamination stations should be set up within the CRC: one for personnel and one for heavy equipment. A large operation may require more than two lines. Access into and out of the CRZ from the Exclusion Zone is through Access Control Points: one each for personnel and equipment entrance, one each for personnel and equipment exit, if feasible.

Table 9-2. Establishing the Hotline

- Visually survey the immediate site environs.
- Determine the locations of:
 - hazardous substances
 - drainage, leachate, and spilled material
 - visible discolorations
- Evaluate data from the initial site survey indicating the presence of:
 - combustible gases
 - organic and inorganic gases, particulates, or vapors
 - ionizing radiation
- Evaluate the results of soil and water sampling.
- Consider the distances needed to prevent an explosion or fire from affecting personnel outside the Exclusion Zone.
- Consider the physical area necessary for site operations.
- Consider meteorological conditions and the potential for contaminants to be blown from the area.
- Secure or mark the Hotline.
- Modify its location, if necessary, as more information becomes available.

The boundary between the Support Zone and the CRZ, called the Contamination Control Line, separates the possibly low contamination area from the clean Support Zone. Access to the CRZ from the Support Zone is through two Access Control Points if feasible: one each for personnel and equipment. Personnel entering the CRZ should be required to wear the personal protective clothing and equipment prescribed for working in the CRZ. To reenter the Support Zone, workers should remove any protective clothing and equipment worn in the CRZ, and leave through the personnel exit Access Control Point.

The personnel stationed in the CRZ are usually the Site Safety Officer, a Personnel Decontamination Station (PDS) Operator, and the emergency response personnel. Additional personnel may assist the PDS Operator by conducting abbreviated decontamination procedures for sample containers.

The CRZ must be well designed to facilitate:

- Decontamination of equipment, PDS operators, personnel, and samples.
- Emergency response: transport for injured personnel (safety harness, stretcher), first-aid equipment (such as bandages, blankets, eye wash, splints, and water), containment equipment (absorbent, fire extinguisher).
- Equipment resupply: air tank changes, personal protective clothing and equipment (such as booties and gloves), sampling equipment (such as bottles and glass rods), and tools.
- Sample packaging and preparation for onsite or offsite laboratories.
- Worker temporary rest area: toilet facilities, bench, chair, liquids, and shade. Water and other potable liquids should be clearly marked and stored properly to ensure that all glasses and cups

are clean. Wash facilities should be located near drinking facilities to allow employees to wash before drinking. Drinking, washing, and toilet facilities should be located in a safe area where protective clothing can be removed. Facilities should be cleaned and inspected regularly. Appropriate protective measures should be taken by maintenance workers.

- Drainage of water and other liquids that are used during decontamination.

Personnel within the CRZ should be required to maintain internal communications, line-of-sight contact with work parties, work party monitoring (e.g., for air time left, fatigue, heat stress, hypothermia), and site security.

Support Zone

The Support Zone is the location of the administrative and other support functions needed to keep the operations in the Exclusion and Contamination Reduction Zones running smoothly. Any function that need not or cannot be performed in a hazardous or potentially hazardous area is performed here. The Command Post Supervisor should be present in the Support Zone. Other personnel present will depend on the functions being performed, and may include the Project Team Leader and field team members who are preparing to enter or who have returned from the Exclusion Zone.

Personnel may wear normal work clothes within this zone. Any potentially contaminated clothing, equipment, and samples must remain in the CRZ until decontaminated.

Support Zone personnel are responsible for alerting the proper agency in the event of an emergency. All emergency telephone numbers, change for the telephone (if necessary), evacuation route maps, and vehicle keys should be kept in the Support Zone.

Support facilities, listed in Table 9-3, are located in the Support Zone. To place these facilities, consider factors such as:

- Accessibility. Topography, open space available, locations of highways and railroad tracks, ease of access for emergency vehicles.
- Resources. Adequate roads, power lines, telephones, shelter, and water.
- Visibility. Line-of-sight to all activities in the Exclusion Zone.
- Wind direction. Upwind of the Exclusion Zone, if possible.
- Distance. As far from the Exclusion Zone as practicable.

Table 9-3. Support Zone Activities

| FACILITY | FUNCTION |
|-------------------------------------|---|
| Command Post | <p>Supervision of all field operations and field teams. Maintenance of communications, including emergency lines of communication. Recordkeeping, including:</p> <ul style="list-style-type: none"> - accident reports - chain-of-custody records - daily logbooks - manifest directories and orders - medical records - personnel training records - site inventories - site safety map - up-to-date Site Safety Plans <p>Providing access to up-to-date safety and health manuals and other reference materials. Interfacing with the public: government agencies, local politicians, medical personnel, the media, and other interested parties. Monitoring work schedules and weather changes. Maintaining site security. Sanitary facilities.</p> |
| Medical Station | <p>First-aid administration. Medical emergency response. Medical monitoring activities. Sanitary facilities.</p> |
| Equipment and Supply Centers | <p>Supply, maintenance, and repair of communications, respiratory, and sampling equipment. Maintenance and repair of vehicles. Replacement of expendable supplies. Storage of monitoring equipment and supplies. Storage may be here or in an onsite field laboratory.</p> |
| Administration | <p>Sample shipment.. Interface with home office. Maintenance of emergency telephone numbers, evacuation route maps, and vehicle keys. Coordination with transporters, disposal sites, and appropriate federal, state, and local regulatory agencies.</p> |
| Field Laboratory | <p>Coordination and processing of environmental and hazardous waste samples. Copies of the sampling plans and procedures should be available for quick reference in the laboratory. Packaging of materials for analysis following the decontamination of the outsides of the sample containers which should be done in the CRZ. This packaging can also be done in ad designated location in the CRZ. Shipping papers and chain-of-custody files should be kept in the Command Post.. Maintenance and storage of laboratory notebooks in designated locations in the laboratory while in use, and in the Command Post when not in use.</p> |

The Buddy System

Most activities in contaminated or otherwise hazardous areas should be conducted with a buddy who is able to:

- Provide his or her partner with assistance.
- Observe his or her partner for signs of chemical or heat exposure.
- Periodically check the integrity of his or her partner's protective clothing.
- Notify the Command Post Supervisor or others if emergency help is needed.

The Access Control Point for personnel entrance to the Exclusion Zone is a convenient location for enforcing the buddy system for two reasons: enforcement is the responsibility of the Project Team Leader, who is stationed in the CRZ, and all personnel who enter the contaminated area must pass through the control point.

The buddy system alone may not be sufficient to ensure that help will be provided in an emergency. At all times, workers in the Exclusion Zone should be in line-of-sight contact or communications contact with the Command Post Supervisor or backup person in the Support Zone.

Site Security

Site security is necessary to:

- Prevent the exposure of unauthorized, unprotected people to site hazards.
- Avoid the increased hazards from vandals or persons seeking to abandon other wastes on the site.
- Prevent theft.
- Avoid interference with safe working procedures.

To maintain site security during working hours:

- Maintain security in the Support Zone and at Access Control Points.
- Establish an identification system to identify authorized persons and limitations to their approved activities.
- Assign responsibility for enforcing authority for entry and exit requirements.
- Erect a fence or other physical barrier around the site.
- If the site is not fenced, post signs around the perimeter and use guards to patrol the perimeter. Guards must be fully apprised of the hazards involved and trained in emergency procedures.



Warning signs and fences help to prevent exposure of unauthorized and unprotected people to site hazards.

Have the Project Team Leader approve all visitors to the site. Make sure they have a valid purpose for entering the site. Have trained site personnel accompany visitors at all times and provide them with the appropriate protective equipment. To maintain site security during off-duty hours:

- If possible, assign trained, in-house technicians for site surveillance. They will be familiar with the site, the nature of the work, the site's hazards, and respiratory protection techniques.

- If necessary, use security guards to patrol the site boundary. Such personnel may be less expensive than trained technicians, but will be more difficult to train in safety procedures and will be less confident in reacting to problems around hazardous substances.
- Enlist public enforcement agencies, such as the local police department, if the site presents a significant risk to local health and safety.
- Secure the equipment.

Communication Systems

Two sets of communication systems should be established: internal communication among personnel on site, and external communication between onsite and offsite personnel.

Internal communication is used to:

- Alert team members to emergencies.
- Pass along safety information, such as the amount of air time left before the next rest period, air change, heat stress check, etc.
- Communicate changes in the work to be accomplished.
- Maintain site control.

Verbal communication at a site can be impeded by onsite background noise and the use of personal protective equipment. For example, speech transmission through a respirator can be poor, and hearing can be impaired by protective hoods and respirator air flow. For effective communication, commands must be pre-arranged. In addition, audio or visual cues can help convey the message. The most important thing is that signals are agreed to in advance.

Table 9-4 lists common internal communication devices. Both a primary and backup system are necessary. A set of signals should be established for use only during emergencies (see Table 12-4 in Chapter 12 for examples).

Effective internal communication also requires the identification of individual workers so that commands can be addressed to the right worker. The worker's name should be marked on the suit and, for long-distance identification, color coding, numbers, or symbols can be added. Flags may be used to help locate personnel in areas where visibility is poor due to obstructions such as accumulated drums, equipment, and waste piles.

All communication devices used in a potentially explosive atmosphere must be intrinsically safe (see footnote in Table 9-4) and not capable of sparking, and should be checked daily to ensure that they are operating.

An external communication system between onsite and offsite personnel is necessary to:

- Coordinate emergency response.
- Report to management.
- Maintain contact with essential offsite personnel.

The primary means of external communication are telephone and radio. If telephone lines are not installed at a site, all team members should know the location of the nearest telephone, and the correct change and necessary telephone numbers should be readily available in the Support Zone.

Table 9-4. Internal Communication Devices

Radio^a.

- Citizen's band
- FM

Noisemakers, including:

- Bell
- Compressed air horn
- Megaphone
- Siren
- Whistle

Visual signals, including:

- Flag
- Flares or smoke^b
- Hand signals
- Lights
- Signal board
- Whole body movements

^aAll radios used in the Exclusion and Contamination Reduction Zones must be certified as intrinsically safe for the situation of intended use [2,3].

^bOnly from the Support Zone.

Safe Work Practices

To maintain a strong safety awareness and enforce safe procedures at a site, a list of standing orders should be developed which state the practices that must always be followed and those that must never occur in the contaminated areas on site. Separate standing orders should be developed for the Contamination Reduction Zone and the Exclusion Zone if the hazards are sufficiently different. Sample standing orders are given in Table 9-5. To ensure that everyone who enters the site is aware of these orders and that a high degree of familiarity with their content is maintained, the list should be:

- Distributed to everyone who enters the site.
- Posted conspicuously at the Command Post.
- Posted conspicuously at the entrance Access Control Points into the Contamination Reduction Zone and/or the Exclusion Zone.
- Reviewed by the Field Team Leader or Project Team Leader with the field crew at the beginning of each workday. In this way, personnel are immediately informed of any new standing orders resulting from a change in site conditions or work activities.

In addition to the standing orders, a hazardous substance information form that lists the names and properties of chemicals present on site should be prepared and posted conspicuously. Employees should be briefed on the chemical information at the beginning of the project or whenever they first join the work team. Daily safety meetings should be held for all employees.

Table 9-5. Sample Standing Orders

For Personnel Entering the Contamination Reduction Zone:

- No smoking, eating, drinking, or application of cosmetics in this zone.
- No matches or lighters in this zone.
- Check in at the entrance Access Control Point before you enter this zone.
- Check out at the exit Access Control Point before you enter this zone.

For Personnel Entering the Exclusion Zone:

- No smoking, eating, drinking, or application of cosmetics in this zone.
- No matches or lighters in this zone.
- Check in at the entrance Access Control Point before you enter this zone.
- Check out at the exit Access Control Point before you enter this zone.
- Always have your buddy with you in this zone.
- Wear an SCBA in this zone.
- If you discover any signs of radioactivity, explosivity, or unusual conditions such as dead animals at the site, exit immediately and report this finding to your supervisor.

Working with tools and heavy equipment is a major hazard at sites. Injuries can result from equipment hitting or running over personnel, impacts from flying objects, burns from hot objects, and damage to protective equipment such as supplied-air respirator systems (see Chapter 8). The following precautions will help preclude injuries due to such hazards:

- Train personnel in proper operating procedures.
- Install adequate onsite roads, signs, lights, and devices.
- Install appropriate equipment guards and engineering controls on tools and equipment. These include rollover protective structures, seat belts, emergency shutoff in case of rollover, and backup warning lights and signals.
- Provide equipment such as cranes, derricks, and power shovels with signs saying "Unlawful to operate this equipment within 10 feet of all power lines."
- Use equipment and tools that are intrinsically safe (see footnote in Table 9-4) and not capable of sparking, and pneumatically and hydraulically driven equipment.
- Where portable electric tools and appliances can be used, (i.e., where there is no potential for flammable or explosive conditions), use three-wire grounded extension cords to prevent electric shocks.
- In hydraulic power tools, use fire-resistant fluid that is capable of retaining its operating characteristics at the most extreme temperatures.
- At the start of each workday, inspect brakes, hydraulic lines, light signals, fire extinguishers, fluid levels, steering, and splash protection.
- Keep all non-essential people out of the work area.
- Prohibit loose-fitting clothing or loose long hair around moving machinery.
- Keep cabs free of all non-essential items and secure all loose items.
- Do *not* exceed the rated load capacity of a vehicle.
- Instruct equipment operators to report to their supervisor(s) any abnormalities such as equipment failure, oozing liquids, unusual odors, etc.
- When an equipment operator must negotiate in tight quarters, provide a second person to ensure adequate clearance.
- Have a signalman direct backing as necessary.

- All onsite internal combustion engines should have spark arrestors that meet requirements for hazardous atmospheres. Refuel in safe areas. Do *not* fuel engines while vehicle is running. Prohibit ignition sources near a fuel area.
- Lower all blades and buckets to the ground and set parking brakes before shutting off the vehicle.
- Implement an ongoing maintenance program for all tools and equipment. Inspect all tools and moving equipment regularly to ensure that parts are secured and intact with no evidence of cracks or areas of weakness, that the equipment turns smoothly with no evidence of wobble, and that it is operating according to manufacturer's specifications. Promptly repair or replace any defective items. Keep maintenance and repair logs.
- Store tools in clean, secure areas so that they will not be damaged, lost, or stolen.
- Keep all heavy equipment that is used in the Exclusion Zone in that zone until the job is done. Completely decontaminate such equipment before moving it into the clean zone.

References

1. U.S. EPA. 1984. Standard Operating Safety Guides. EPA Office of Emergency and Remedial Response, Hazardous Response Support Division, Edison, NJ.
2. National Fire Protection Association. National Electrical Code, Chapter 5. Articles 500-503. National Fire Codes, NFPA 70.
3. National Fire Protection Association. Manual for Classification of Gases, Vapors, and Dusts for Electrical Equipment in Hazardous Classified Locations. National Fire Codes, NFPA 497M.

10. Decontamination

Contents

| | |
|--|-------|
| Introduction | 10-1 |
| Decontamination Plan | 10-1 |
| Prevention of Contamination | 10-2 |
| Types of Contamination | 10-3 |
| Decontamination Methods | 10-3 |
| Physical Removal | 10-3 |
| Chemical Removal | 10-4 |
| Testing for the Effectiveness of Decontamination | 10-6 |
| Visual Observation | 10-6 |
| Wipe Sampling | 10-7 |
| Cleaning Solution Analysis | 10-7 |
| Testing for Permeation | 10-7 |
| Health and Safety Hazards | 10-7 |
| Decontamination Facility Design | 10-8 |
| Decontamination Equipment Selection | 10-9 |
| Disposal Methods | 10-11 |
| Personal Protection | 10-11 |
| Emergency Decontamination | 10-12 |
| References | 10-12 |

Introduction

Decontamination - the process of removing or neutralizing contaminants that have accumulated on personnel and equipment - is critical to health and safety at hazardous waste sites. Decontamination protects workers from hazardous substances that may contaminate and eventually permeate the protective clothing, respiratory equipment, tools, vehicles, and other equipment used on site; it protects all site personnel by minimizing the transfer of harmful materials into clean areas; it helps prevent mixing of incompatible chemicals; and it protects the community by preventing uncontrolled transportation of contaminants from the site.

This chapter describes the types of contamination that workers may encounter at a waste site, the factors that influence the extent of contamination, and methods for preventing or reducing contamination. In addition, this chapter provides general guidelines for designing and selecting decontamination procedures at a site, and it presents a decision aid for evaluating the health and safety aspects of decontamination methods. The chapter does not cover decontamination of radioactively contaminated personnel or equipment. A health physicist should be consulted if this situation arises.

Decontamination Plan

A decontamination plan should be developed (as part of the Site Safety Plan) and set up before any personnel or equipment may enter areas where the potential for exposure to hazardous substances exists. The decontamination plan should:

- Determine the number and layout of decontamination stations.

- Determine the decontamination equipment needed.
- Determine appropriate decontamination methods.
- Establish procedures to prevent contamination of clean areas.
- Establish methods and procedures to minimize worker contact with contaminants during removal of personal protective clothing and equipment (PPE).
- Establish methods for disposing of clothing and equipment that are not completely decontaminated.

The plan should be revised whenever the type of personal protective clothing or equipment changes, the site conditions change, or the site hazards are reassessed based on new information.

Prevention of Contamination

The first step in decontamination is to establish Standard Operating Procedures that minimize contact with waste and thus the potential for contamination. For example:

- Stress work practices that minimize contact with hazardous substances (e.g., do not walk through areas of obvious contamination, do not directly touch potentially hazardous substances).
- Use remote sampling, handling, and container opening techniques (e.g., drum grapplers, pneumatic impact wrenches).
- Protect monitoring and sampling instruments by bagging. Make openings in the bags for sample ports and sensors that must contact site materials.
- Wear disposable outer garments and use disposable equipment where appropriate.
- Cover equipment and tools with a strippable coating which can be removed during decontamination.
- Encase the source of contaminants, e.g., with plastic sheeting or overpacks.

In addition, Standard Operating Procedures should be established that maximize worker protection. For example, proper procedures for dressing prior to entering the Exclusion Zone will minimize the potential for contaminants to bypass the protective clothing and escape decontamination. In general, all fasteners should be used (i.e., zippers fully closed, all buttons used, all snaps closed, etc.). Gloves and boots should be tucked under the sleeves and legs of outer clothing, and hoods (if not attached) should be worn outside the collar. Another pair of tough outer gloves is often worn over the sleeves. All junctures should be taped to prevent contaminants from running inside the gloves, boots, and jackets (or suits, if one-piece construction).

Prior to each use, the personal protective equipment (PPE) should be checked to ensure that it contains no cuts or punctures that could expose workers to wastes. Similarly, any injuries to the skin surface, such as cuts and scratches, may enhance the potential for chemicals or infectious agents that directly contact the worker's skin to penetrate into the body. Particular care should be taken to protect these areas. Workers with large areas of damaged skin should be kept from working on site until the skin heals.

All personnel should be trained in the Standard Operating Procedures for minimizing contact and maximizing worker protection, and these procedures should be enforced throughout site operations.

Types of Contamination

Contaminants can be located either on the surface of personal protective equipment or permeated into the PPE material. Surface contaminants may be easy to detect and remove; however, contaminants that have permeated a material are difficult or impossible to detect and remove. If contaminants that have permeated a material are not removed by decontamination, they may continue to permeate to either surface of the material where they can cause an unexpected exposure.

Five major factors affect the extent of permeation:

- **Contact time.** The longer a contaminant is in contact with an object, the greater the probability and extent of permeation. For this reason, minimizing contact time is one of the most important objectives of a decontamination program.
- **Concentration.** Molecules flow from areas of high concentration to areas of low concentration. As concentrations of wastes increase, the potential for permeation of personal protective clothing increases.
- **Temperature.** An increase in temperature generally increases the permeation rate of contaminants.
- **Size of contaminant molecules and pore space.** Permeation increases as the contaminant molecule becomes smaller, and as the pore space of the material to be permeated increases.
- **Physical state of wastes.** As a rule, gases, vapors, and low-viscosity liquids tend to permeate more readily than high-viscosity liquids or solids.

Decontamination Methods

All personnel, clothing, equipment, and samples leaving the contaminated area of a site (generally referred to as the Exclusion Zone) must be decontaminated to remove any harmful chemicals or infectious organisms that may have adhered to them.

Decontamination methods either (1) physically remove contaminants, (2) inactivate contaminants by chemical detoxification or disinfection/sterilization, or (3) remove contaminants by a combination of both physical and chemical means. Various decontamination methods are listed in Table 10-1.

Physical Removal

In many cases, gross contamination can be removed by physical means involving dislodging/displacement, rinsing, wiping off, and evaporation. Physical methods involving high pressure and/or heat should be used only as necessary and with caution since they can spread contamination and cause burns. Contaminants that can be removed by physical means can be categorized as follows:

- **Loose contaminants.** Dusts and vapors that cling to equipment and workers or become trapped in small openings, such as the weave of the clothing fabrics, can be removed with water or a liquid rinse (see photograph). Removal of electrostatically attached materials can be enhanced by coating the clothing or equipment with anti-static solutions. These are available commercially as wash additives or anti-static sprays.
- **Adhering contaminants.** Some contaminants adhere by forces other than electrostatic attraction. Adhesive qualities vary greatly with the specific contaminants and the temperature. For example, contaminants such as glues, cements, resins, and muds

- have much greater adhesive properties than elemental mercury and, consequently, are difficult to remove by physical means. Physical removal methods for gross contaminants include scraping, brushing, and wiping. Removal of adhesive contaminants can be enhanced through certain methods such as solidifying, freezing (e.g., using dry ice or ice water), adsorption or absorption (e.g., with powdered lime or kitty litter), or melting.
- Volatile liquids. Volatile liquid contaminants can be removed from protective clothing or equipment by evaporation followed by a water rinse. Evaporation of volatile liquids can be enhanced by using steam jets. With any evaporation or vaporization process, care must be taken to prevent worker inhalation of the vaporized chemicals.

Table 10-1. Some Decontamination Methods

| |
|--|
| <p>REMOVAL:</p> <ul style="list-style-type: none"> • Contaminant Removal <ul style="list-style-type: none"> - Water rinse, using pressurized or gravity flow. - Chemical leaching and extraction. - Evaporation/vaporization. - Pressurized air jets. - Scrubbing/scraping. Commonly done using brushes, scrapers, or sponges and water-compatible solvent cleaning solutions. - Steam jets. • Removal of Contaminated Surfaces <ul style="list-style-type: none"> - Disposal of deeply permeated materials, e.g., clothing, floor mats, and seats. - Disposal of protective coverings/coatings. <p>INACTIVATION</p> <ul style="list-style-type: none"> • Chemical Detoxification <ul style="list-style-type: none"> - Halogen stripping. - Neutralization. - Oxidation/reduction. - Thermal degradation. • Disinfection/Sterilization <ul style="list-style-type: none"> - Chemical disinfection. - Dry heat sterilization. - Gas/vapor sterilization. - Irradiation. - Steam sterilization. |
|--|

Chemical Removal

Physical removal of gross contamination should be followed by a wash/rinse process using cleaning solutions. These cleaning solutions normally utilize one or more of the following methods:

- Dissolving contaminants. Chemical removal of surface contaminants can be accomplished by dissolving them in a solvent. The solvent must be chemically compatible with the equipment being cleaned. This is particularly important when decontaminating personal protective clothing constructed of organic materials that could be damaged or dissolved by organic solvents. In addition, care must be taken in selecting, using, and disposing of any organic solvents that may be flammable or potentially toxic. Organic solvents include alcohols, ethers, ketones, aromatics, straight-chain alkanes, and common petroleum products.

- Halogenated solvents generally are incompatible with personal protective equipment and are toxic. They should only be used for decontamination in extreme cases where other cleaning agents will not remove the contaminant.
- Table 10-2 provides a general guide to the solubility of several contaminant categories in four types of solvents: water, dilute acids, dilute bases, and organic solvents. Because of the potential hazards, decontamination using chemicals should be done only if recommended by an industrial hygienist or other qualified health professional.
- Surfactants. Surfactants augment physical cleaning methods by reducing adhesion forces between contaminants and the surface being cleaned, and by preventing redeposit of the contaminants. Household detergents are among the most common surfactants. Some detergents can be used with organic solvents to improve the dissolving and dispersal of contaminants into the solvent [1].
- Solidification. Solidifying liquid or gel contaminants can enhance their physical removal. The mechanisms of solidification are: (1) moisture removal through the use of absorbents such as grounded clay or powdered lime; (2) chemical reactions via polymerization catalysts and chemical reagents; and (3) freezing using ice water.
- Rinsing. Rinsing removes contaminants through dilution, physical attraction, and solubilization. Multiple rinses with clean solutions remove more contaminants than a single rinse with the same volume of solution. Continuous rinsing with large volumes will remove even more contaminants than multiple rinsings with a lesser total volume.
- Disinfection/Sterilization. Chemical disinfectants are a practical means of inactivating infectious agents. Unfortunately, standard sterilization techniques are generally impractical for large equipment and for personal protective clothing and equipment. For this reason, disposable PPE is recommended for use with infectious agents.



Gross contaminants can be removed with water or a liquid rinse. Here, a member of the decontamination team rinses and scrubs the boots of a worker with a soft-bristled brush. Both individuals are wearing Level C personal protective equipment.

Many factors, such as cost, availability, and ease of implementation, influence the selection of a decontamination method. From a health and safety standpoint, two key questions must be addressed:

- Is the decontamination method effective for the specific substances present?
- Does the method itself pose any health or safety hazards?

Table 10-2. General Guide to Solubility of Contaminants in Four Solvent Types

| SOLVENT | SOLUBLE CONTAMINANTS |
|---|--|
| Water | Low-chain hydrocarbons. Inorganic compounds. Salts. Some organic acids and other polar compounds. |
| Dilute Acids | Basic (caustic) compounds. Amines. Hydrazines. |
| Dilute Bases For example - detergent - soap | Acidic compounds. Phenols. Thiols. Some nitro and sulfonic compounds. |
| Organic Solvents^a For example: - alcohols - ethers - ketones - aromatics - straight-chain alkalines (e.g., hexane) - common petroleum products (e.g., fuel oil, kerosene) | Nonpolar compounds (e.g., some organic compounds). |

^aWARNING: Some organic solvents can permeate and/or degrade the protective clothing.

Testing for the Effectiveness of Decontamination

Decontamination methods vary in their effectiveness for removing different substances. The effectiveness of any decontamination method should be assessed at the beginning of a program and periodically throughout the lifetime of the program. If contaminated materials are not being removed or are penetrating protective clothing, the decontamination program must be revised. The following methods may be useful in assessing the effectiveness of decontamination.

Visual Observation

There is no reliable test to immediately determine how effective decontamination is. In some cases, effectiveness can be estimated by visual observation.

- Natural light. Discolorations, stains, corrosive effects, visible dirt, or alterations in clothing fabric may indicate that contaminants have not been removed. However, not all contaminants leave visible traces; many contaminants can permeate clothing and are not easily observed.

- Ultraviolet light. Certain contaminants, such as polycyclic aromatic hydrocarbons, which are common in many refined oils and solvent wastes, fluoresce and can be visually detected when exposed to ultraviolet light. Ultraviolet light can be used to observe contamination of skin, clothing, and equipment; however, certain areas of the skin may fluoresce naturally, thereby introducing an uncertainty into the test [2,3,4]. In addition, use of ultraviolet light can increase the risk of skin cancer and eye damage; therefore, a qualified health professional should assess the benefits and risks associated with ultraviolet light prior to its use at a waste site.

Wipe Sampling

Wipe testing provides after-the-fact information on the effectiveness of decontamination. In this procedure, a dry or wet cloth, glass fiber filter paper, or swab is wiped over the surface of the potentially contaminated object and then analyzed in a laboratory. Both the inner and outer surfaces of protective clothing should be tested. Skin may also be tested using wipe samples.

Cleaning Solution Analysis

Another way to test the effectiveness of decontamination procedures is to analyze for contaminants left in the cleaning solutions. Elevated levels of contaminants in the final rinse solution may suggest that additional cleaning and rinsing are needed.

Testing for Permeation

Testing for the presence of permeated chemical contaminants requires that pieces of the protective garments be sent to a laboratory for analysis.

Health and Safety Hazards

While decontamination is performed to protect health and safety, it can pose hazards under certain circumstances. Decontamination methods may:

- Be incompatible with the hazardous substances being removed (i.e., a decontamination method may react with contaminants to produce an explosion, heat, or toxic products).
- Be incompatible with the clothing or equipment being decontaminated (e.g., some organic solvents can permeate and/or degrade protective clothing).
- Pose a direct health hazard to workers (e.g., vapors from chemical decontamination solutions may be hazardous if inhaled, or they may be flammable).

The chemical and physical compatibility of the decontamination solutions or other decontamination materials must be determined before they are used. Any decontamination method that permeates, degrades, damages, or otherwise impairs the safe functioning of the PPE is incompatible with such PPE and should not be used. If a decontamination method does pose a direct health hazard, measures must be taken to protect both decontamination personnel and the workers being decontaminated. Figure 10-1 presents a decision aid for evaluating the health and safety aspects of decontamination methods.

Figure 10-1. Decision Aid for Evaluating Health and Safety Aspects of Decontamination Methods.

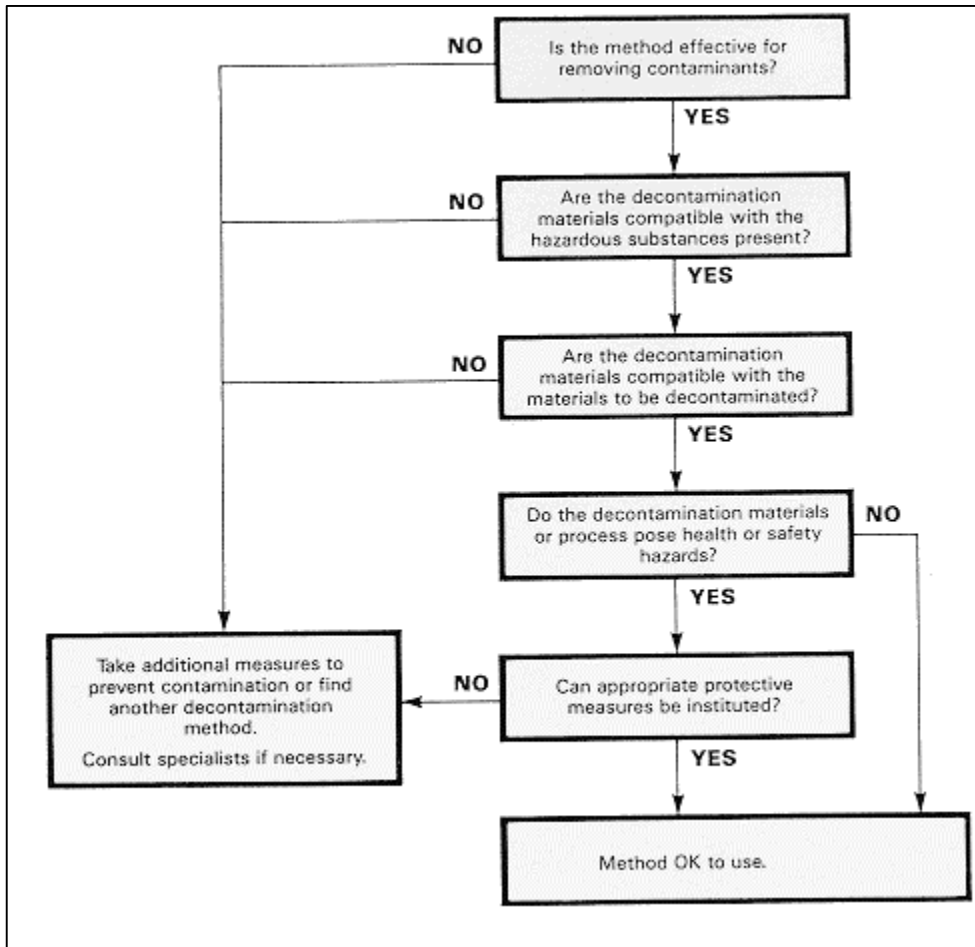

Decontamination Facility Design

At a hazardous waste site, decontamination facilities should be located in the Contamination Reduction Zone (CRZ), i.e., the area between the Exclusion Zone (the contaminated area) and the Support Zone (the clean area) as shown in Figure 9-1 in Chapter 9.

The level and types of decontamination procedures required depend on several site-specific factors including:

- The chemical, physical, and toxicological properties of the wastes.
- The pathogenicity of infectious wastes.
- The amount, location, and containment of contaminants.
- The potential for, and location of, exposure based on assigned worker duties, activities, and functions.
- The potential for wastes to permeate, degrade, or penetrate materials used for personal protective clothing and equipment, vehicles, tools, buildings, and structures.
- The proximity of incompatible wastes.
- The movement of personnel and/or equipment among different zones.
- Emergencies.
- The methods available for protecting workers during decontamination.
- The impact of the decontamination process and compounds on worker safety and health.

Decontamination procedures must provide an organized process by which levels of contamination are reduced. The decontamination process should consist of a series of procedures performed in a specific sequence. For example, outer, more heavily contaminated items (e.g., outer boots and gloves) should be decontaminated and removed first, followed by decontamination and removal of inner, less contaminated items (e.g., jackets and pants). Each procedure should be performed at a separate station in order to prevent cross contamination. The sequence of stations is called the decontamination line.

Stations should be separated physically to prevent cross contamination and should be arranged in order of decreasing contamination, preferably in a straight line. Separate flow patterns and stations should be provided to isolate workers from different contamination zones containing incompatible wastes. Entry and exit points should be conspicuously marked, and the entry to the Contamination Reduction Zone (CRZ) from the Exclusion Zone should be separate from the entry to the Exclusion Zone from the CRZ. Dressing stations for entry to the CRZ should be separate from redressing areas for exit from the CRZ. Personnel who wish to enter clean areas of the decontamination facility, such as locker rooms, should be completely decontaminated.

Examples of decontamination lines and procedures for personnel wearing various levels of protection are provided in Appendix D.



A member of the decontamination team suited in Level B personal protective equipment stands by to scrub down a worker after an initial rinse down in the decontamination shower

Decontamination Equipment Selection

Table 10-3 lists recommended equipment for decontamination of personnel, personal protective clothing, and equipment. In selecting decontamination equipment, consider whether the equipment itself can be decontaminated for reuse or can be easily disposed of. Table 10-4 lists recommended equipment for decontamination of large equipment and vehicles. Note that other types of equipment Table 10-3. Note that other types of equipment not listed in Tables 10-3 and 10-4 may be appropriate in certain situations.

Table 10-3. Some Recommended Equipment for Decontamination of Personnel and Personal Protective Clothing and Equipment

- Drop cloths of plastic or other suitable materials on which heavily contaminated equipment and outer protective clothing may be deposited.
- Collection containers, such as drums or suitably lined trash cans, for storing disposable clothing and heavily contaminated personal protective clothing or equipment that must be discarded.
- Lined box with absorbents for wiping or rinsing off gross contaminants and liquid contaminants.
- Large galvanized tubs, stock tanks, or children's wading pools to hold wash and rinse solutions. These should be at least large enough for a worker to place a booted foot in, and should have either no drain or a drain connected to a collection tank or appropriate treatment system.
- Wash solutions selected to wash off and reduce the hazards associated with the contaminants.
- Rinse solutions selected to remove contaminants and contaminated wash solutions.
- Long-handled, soft-bristled brushes to help wash and rinse off contaminants.
- Paper or cloth towels for drying protective clothing and equipment.
- Lockers and cabinets for storage of decontaminated clothing and equipment.
- Metal or plastic cans or drums for contaminated wash and rinse solutions.
- Plastic sheeting, sealed pads with drains, or other appropriate methods for containing and collecting contaminated wash and rinse solutions spilled during decontamination.
- Shower facilities for full body wash or, at a minimum, personal wash sinks (with drains connected to a collection tank or appropriate treatment system).
- Soap or wash solution, wash cloths, and towels for personnel.
- Lockers or closets for clean clothing and personal item storage.

Table 10-4. Some Recommended Equipment for Heavy Equipment and Vehicle Decontamination

- Storage tanks of appropriate treatment systems for temporary storage and/or treatment of contaminated wash and rinse solutions.
- Drains or pumps for collection of contaminated wash and rinse solutions.
- Long-handled brushes for general exterior cleaning.
- Wash solutions selected to remove and reduce the hazards associated with the contamination.
- Rinse solutions selected to remove contaminants and contaminated wash solutions.
- Pressurized sprayers for washing and rinsing, particularly hard-to-reach areas.
- Curtains, enclosures, or spray booths to contain splashes from pressurized sprays.
- Long-handled brushes, rods, and shovels for dislodging contaminants and contaminated soil caught in tires and the undersides of vehicles and equipment.
- Containers to hold contaminants and contaminated soil removed from tires and the undersides of vehicles and equipment.
- Wash and rinse buckets for use in the decontamination of operator areas inside vehicles and equipment.
- Brooms and brushes for cleaning operator areas inside vehicles and equipment.
- Containers for storage and disposal of contaminated wash and rinse solutions, damaged or heavily contaminated parts, and equipment to be discarded.

Disposal Methods

All equipment used for decontamination must be decontaminated and/or disposed of properly. Buckets, brushes, clothing, tools, and other contaminated equipment should be collected, placed in containers, and labeled. Also, all spent solutions and wash water should be collected and disposed of properly. Clothing that is not completely decontaminated should be placed in plastic bags, pending further decontamination and/or disposal.

Personal Protection

Decontamination workers who initially come in contact with personnel and equipment leaving the Exclusion Zone will require more protection from contaminants than decontamination workers who are assigned to the last station in the decontamination line. In some cases, decontamination personnel should wear the same levels of PPE as workers in the Exclusion Zone. In other cases, decontamination personnel may be sufficiently protected by wearing one level lower protection (e.g., wearing Level C protection while decontaminating workers who are wearing Level B).

The level of protection required will vary with the type of decontamination equipment used. For example, workers using a steam jet may need a different type of respiratory protection than other decontamination personnel because of the high moisture levels produced by steam jets. In some situations, the cleaning solutions used and wastes removed during decontamination may generate harmful vapors. Appropriate equipment and clothing for protecting decontamination personnel should be selected by a qualified health and safety expert.

All decontamination workers are in a contaminated area and must themselves be decontaminated before entering the clean Support Zone. The extent of their decontamination should be determined by the types of contaminants they may have contacted and the type of work they performed.

Emergency Decontamination

In addition to routine decontamination procedures, emergency decontamination procedures must be established. In an emergency, the primary concern is to prevent the loss of life or severe injury to site personnel. If immediate medical treatment is required to save a life, decontamination should be delayed until the victim is stabilized. If decontamination can be performed without interfering with essential life-saving techniques or first aid, or if a worker has been contaminated with an extremely toxic or corrosive material that could cause severe injury or loss of life, decontamination must be performed immediately. If an emergency due to a heat-related illness develops, protective clothing should be removed from the victim as soon as possible to reduce the heat stress. During an emergency, provisions must also be made for protecting medical personnel and disposing of contaminated clothing and equipment. See Chapter 12 for further information on decontamination during emergencies.

References

1. Rosen, M.J. 1978. Surfactants and Interfacial Phenomena. Wiley-Interscience Publication, NY. 304 pp.
2. Vo-Dinh, T. 1983. Surface detection of contamination: Principles, applications, and recent developments. J. Environ. Sci. January/February 1983, pp. 40-43.
3. Vo-Dinh, T. and R.B. Gammage. 1981. The Use of a Fiberoptics Skin Contamination Monitor in the Workplace. Chemical Hazards in the Workplace, American Chemical Society. pp 269-281.
4. Vo-Dinh, T. and R.B. Gammage. 1981. The lightpipe luminoscope for monitoring occupational skin contamination. J. Am. Ind. Hyg. Assoc. 42:112-120.

11. Handling Drums and Other Containers

Contents

| | |
|--|-------|
| Introduction | 11-1 |
| Inspection | 11-3 |
| Planning | 11-3 |
| Handling | 11-4 |
| Drums Containing Radioactive Waste | 11-5 |
| Drums that May Contain Explosive or Shock-Sensitive Wastes | 11-5 |
| Bulging Drums | 11-6 |
| Drums Containing Packaged Laboratory Wastes (Lab Packs) | 11-6 |
| Leaking, Open, and Deteriorated Drums | 11-6 |
| Buried Drums | 11-6 |
| Opening | 11-8 |
| Sampling | 11-10 |
| Characterization | 11-10 |
| Staging | 11-11 |
| Bulking | 11-13 |
| Shipment | 11-14 |
| Special Case Problems | 11-14 |
| Tanks and Vaults | 11-14 |
| Vacuum Trucks | 11-15 |
| Elevated Tanks | 11-15 |
| Compressed Gas Cylinders | 11-15 |
| Ponds and Lagoons | 11-15 |
| References | 11-16 |

Introduction

Accidents may occur during handling of drums and other hazardous waste containers. Hazards include detonations, fires, explosions, vapor generation, and physical injury resulting from moving heavy containers by hand and working around stacked drums, heavy equipment, and deteriorated drums. While these hazards are always present, proper work practices-such as minimizing handling and using equipment and procedures that isolate workers from hazardous substances-can minimize the risks to site personnel.

This chapter defines practices and procedures for safe handling of drums and other hazardous waste containers. It is intended to aid the Project Team Leader in setting up a waste container handling program. In addition to reading this chapter, the Project Team Leader should also be aware of all pertinent regulations. OSHA regulations (29 CFR Parts 1910 and 1926) include general requirements and standards for storing, containing, and handling chemicals and containers, and for maintaining equipment used for handling materials. EPA regulations (40 CFR Part 265) stipulate requirements for types of containers, maintenance of containers and containment structures, and design and maintenance of storage areas. DOT regulations (49 CFR Parts 171 through 178) also stipulate requirements for containers and procedures for shipment of hazardous wastes.

Containers are handled during characterization and removal of their contents and during other operations. A flow chart showing one set of possible procedures for drum handling is given in Figure 11-1. Guidance

for safely performing the procedures shown in Figure 11-1 is provided in the following sections of this chapter. The final section, *Special Case Problems*, describes the handling of tanks, vaults, vacuum trucks, elevated tanks, and compressed gas cylinders.

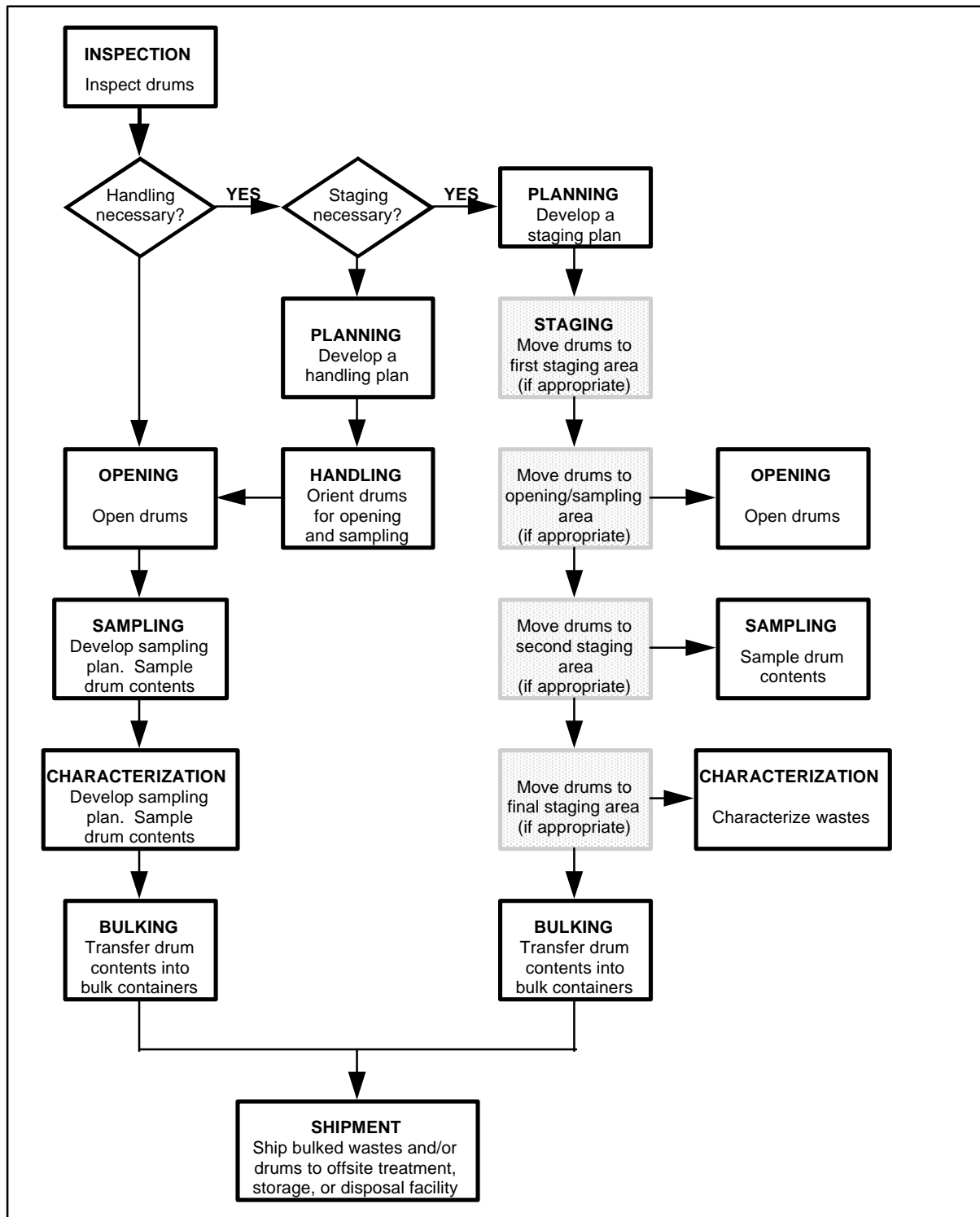

Figure 11-1. Flow Chart for Drum Handling. (Dashed boxes indicate optional steps. Number of staging areas necessary is site specific.)

Inspection

The appropriate procedures for handling drums depend on the drum contents. Thus, prior to any handling, drums should be visually inspected to gain as much information as possible about their contents. The inspection crew should look for:

- Symbols, words, or other marks on the drum indicating that its contents are hazardous, e.g., radioactive, explosive, corrosive, toxic, flammable.
- Symbols, words, or other marks on a drum indicating that it contains discarded laboratory chemicals, reagents, or other potentially dangerous materials in small-volume individual containers (see Table 11-1).
- Signs of deterioration such as corrosion, rust, and leaks.
- Signs that the drum is under pressure such as swelling and bulging.
- Drum type (see Table 11-1).
- Configuration of the drumhead (see Table 11-2).

Conditions in the immediate vicinity of the drums may provide information about drum contents and their associated hazards. Monitoring should be conducted around the drums using instruments such as a gamma radiation survey instrument, organic vapor monitors, and a combustible gas meter.

The results of this survey can be used to classify the drums into preliminary hazard categories, for example:

- Radioactive.
- Leaking/deteriorated.
- Bulging.
- Explosive/shock-sensitive.
- Contains small-volume individual containers of laboratory wastes or other dangerous materials.

As a precautionary measure, personnel should assume that unlabelled drums contain hazardous materials until their contents are characterized. Also, they should bear in mind that drums are frequently mislabeled-particularly drums that are reused. Thus, a drum's label may not accurately describe its contents.

If buried drums are suspected, ground-penetrating systems, such as electromagnetic wave, electrical resistivity, ground-penetrating radar, magnetometry, and metal detection, can be used to estimate the location and depth of the drums. Table 11-1. Special Drum Types and Their Associated Hazards

Planning

Since drum handling is fraught with danger, every step of the operation should be carefully planned, based on all the information available at the time. The results of the preliminary inspection can be used to determine (1) if any hazards are present and the appropriate response, and (2) which drums need to be moved in order to be opened and sampled. A preliminary plan should be developed which specifies the extent of handling necessary, the personnel selected for the job, and the most appropriate procedures based on the hazards associated with the probable drum contents as determined by visual inspection. This plan should be revised as new information is obtained during drum handling.

Table 11-1. Special Drum Types and Their Associated Hazards

| | |
|--|--|
| Polyethylene or PVC-Lined Drums | Often contain strong acids or bases. If the lining is punctured, the substance usually quickly corrodes the steel, resulting in a significant leak or spill. |
| Exotic Metal Drums (e.g., aluminum, nickel, stainless steel, or other unusual metal) | Very expensive drums that usually contain an extremely dangerous material. |
| Single-Walled Drums Used as a Pressure Vessel | These drums have fittings for both product filling and placement of an inert gas, such as nitrogen. May contain reactive, flammable, or explosive substances. |
| Laboratory Packs | Used for disposal of expired chemicals and process samples from university laboratories, hospitals, and similar institutions. Individual containers within the lab pack are often not packed in absorbent material. They may contain incompatible materials, radioisotopes, shock-sensitive, highly volatile, highly corrosive, or very toxic exotic chemicals. Laboratory packs can be an ignition source for fires at hazardous waste sites. |

Handling

The purpose of handling is to (1) respond to any obvious problems that might impair worker safety, such as radioactivity, leakage, or the presence of explosive substances, (2) unstack and orient drums for sampling, and (3) if necessary, to organize drums into different areas on site to facilitate characterization and remedial action (see *Staging* in this chapter). Handling may or may not be necessary, depending on how the drums are positioned at a site.

Since accidents occur frequently during handling, particularly initial handling, drums should only be handled if necessary. Prior to handling, all personnel should be warned about the hazards of handling, and instructed to minimize handling as much as possible and to avoid unnecessary handling. In all phases of handling, personnel should be alert for new information about potential hazards. These hazards should be responded to before continuing with more routine handling operations. Overpack drums (larger drums in which leaking or damaged drums are placed for storage or shipment [see 49 CFR Part 173.3(c)]) and an adequate volume of absorbent should be kept near areas where minor spills may occur. Where major spills may occur, a containment berm adequate to contain the entire volume of liquid in the drums should be constructed before any handling takes place. If the drum contents spill, personnel trained in spill response should be used to isolate and contain the spill.

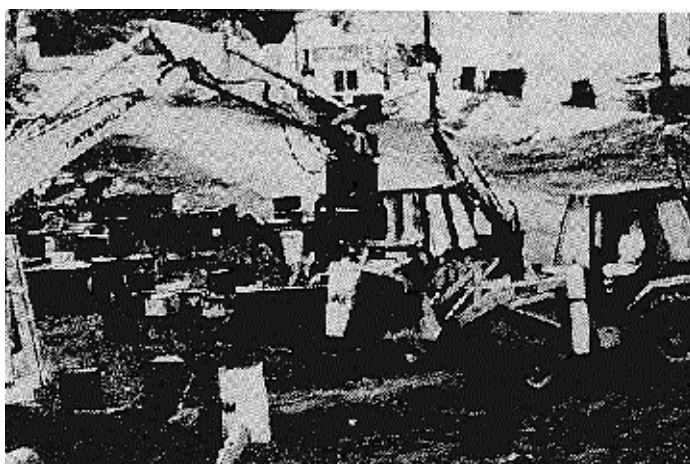

Backhoe with drum grapple.

Several types of equipment can be used to move drums: (1) A drum grappler attached to a hydraulic excavator; (2) a small front-end loader, which can be either loaded manually or equipped with a bucket sling; (3) a rough terrain forklift; (4) a roller conveyor equipped with solid rollers; and (5) drum carts designed specifically for drum handling. Drums are also sometimes moved manually. The drum grappler is the preferred piece of equipment for drum handling. It keeps the operator removed from the drums so that there is less likelihood of injury if the drums detonate or rupture. If a drum is leaking, the operator can stop the leak by rotating the drum and immediately placing it into an overpack. In case of an explosion, grappler claws help protect the operator by partially deflecting the force of the explosion.

The following procedures can be used to maximize worker safety during drum handling and movement:

- Train personnel in proper lifting and moving techniques to prevent back injuries.
- Make sure the vehicle selected has sufficient rated load capacity to handle the anticipated loads, and make sure the vehicle can operate smoothly on the available road surface.
- Air condition the cabs of vehicles to increase operator efficiency; protect the operator with heavy splash shields.
- Supply operators with appropriate respiratory protective equipment when needed. Normally either a combination SCBA/SAR with the air tank fastened to the vehicle, or an airline respirator and an escape SCBA are used because of the high potential hazards of drum handling. This improves operator efficiency and provides protection in case the operator must abandon the equipment.
- Have overpacks ready before any attempt is made to move drums.
- Before moving anything, determine the most appropriate sequence in which the various drums and other containers should be moved. For example, small containers may have to be removed first to permit heavy equipment to enter and move the drums.
- Exercise extreme caution in handling drums that are not intact and tightly sealed.
- Ensure that operators have a clear view of the roadway when carrying drums. Where necessary, have ground workers available to guide the operator's motion.

Drums Containing Radioactive Waste

- If the drum exhibits radiation levels above background (see Table 6-2) immediately contact a health physicist. Do *not* handle any drums that are determined to be radioactive until persons with expertise in this area have been consulted.

Drums that May Contain Explosive or Shock-Sensitive Waste

- If a drum is suspected to contain explosive or shock-sensitive waste as determined by visual inspection, seek specialized assistance before any handling.
- If handling is necessary, handle these drums with *extreme caution*.
- Prior to handling these drums, make sure all nonessential personnel have moved a safe distance away.
- Use a grappler unit constructed for explosive containment for initial handling of such drums.
- Palletize the drums prior to transport. Secure drums to pallets.
- Use an audible siren signal system, similar to that employed in conventional blasting operations, to signal the commencement and completion of explosive waste handling activities.
- Maintain continuous communication with the Site Safety Officer and/or the command post until drum handling operations are complete.

Bulging Drums

- Pressurized drums are extremely hazardous. Wherever possible, do not move drums that may be under internal pressure, as evidenced by bulging or swelling.
- If a pressurized drum has to be moved, whenever possible handle the drum with a grappler unit constructed for explosive containment. Either move the bulged drum only as far as necessary to allow seating on firm ground, or carefully overpack the drum. Exercise extreme caution when working with or adjacent to potentially pressurized drums.

Drums Containing Packaged Laboratory Wastes (Lab Packs)

Laboratory packs (i.e., drums containing individual containers of laboratory materials normally surrounded by cushioning absorbent material) can be an ignition source for fires at hazardous waste sites. They sometimes contain shock-sensitive materials. Such containers should be considered to hold explosive or shock-sensitive wastes until otherwise characterized. If handling is required, the following precautions are among those that should be taken:

- Prior to handling or transporting lab packs, make sure all non-essential personnel have moved a safe distance away.
- Whenever possible, use a grappler unit constructed for explosive containment for initial handling of such drums.
- Maintain continuous communication with the Site Safety Officer and/or the command post until handling operations are complete.
- Once a lab pack has been opened, have a chemist inspect, classify, and segregate the bottles within it, without opening them, according to the hazards of the wastes. An example of a system for classifying lab pack wastes is provided in Table 11-3. The objective of a classification system is to ensure safe segregation of the lab packs' contents. Pack these bottles with sufficient cushioning and absorption materials to prevent excessive movement of the bottles and to absorb all free liquids, and ship them to an approved disposal facility.
- If crystalline material is noted at the neck of any bottle, handle it as a shock-sensitive waste, due to the potential presence of picric acid or other similar material, and get expert advice before attempting to handle it.
- Palletize the repacked drums prior to transport. Secure the drums to pallets.

Leaking, Open, and Deteriorated Drums

- If a drum containing a liquid cannot be moved without rupture, immediately transfer its contents to a sound drum using a pump designed for transferring that liquid.
- Using a drum grappler, place immediately in overpack containers:
- Leaking drums that contain sludges or semi-solids.
- Open drums that contain liquid or solid waste.
- Deteriorated drums that can be moved without rupture.

Buried Drums

- Prior to initiating subsurface excavation, use ground penetrating systems to estimate the location and depth of the drums (see *Inspection* in this chapter).
- Remove soil with great caution to minimize the potential for drum rupture.
- Have a dry chemical fire extinguisher on hand to control small fires.

**Table 11-3. Example of Lab Pack Content
Classification System for Disposal**

| CLASSIFICATION | EXAMPLES |
|--|--|
| Inorganic acids | Hydrochloric Sulfuric |
| Inorganic bases | Sodium hydroxide Potassium hydroxide |
| Strong oxidizing agents | Ammonium nitrate Barium nitrate Sodium chlorate Sodium peroxide |
| Strong reducing agents | Sodium thiosulfate Oxalic acid Sodium sulphite |
| Anhydrous organics and organometallics | Tetraethyl lead Phenylmercuric chloride |
| Anhydrous inorganics and metal hydrides | Potassium hydride Sodium hydride Sodium metal Potassium |
| Toxic organics | PCBs Insecticides |
| Flammable organics | Hexane Toluene Acetone |
| Inorganics | Sodium carbonate Potassium chloride |
| Inorganic cyanides | Potassium cyanide Sodium cyanide Copper cyanide |
| Organic Cyanides | Cyanoacetamide |
| Toxic metals | Arsenic Cadmium Lead Mercury |

Opening

Drums are usually opened and sampled in place during site investigations. However, remedial and emergency operations may require a separate drum opening area (see *Staging* in this chapter). Procedures for opening drums are the same, regardless of where the drums are opened. To enhance the efficiency and safety of drum-opening personnel, the following procedures should be instituted.

- If a supplied-air respiratory protection system is used, place a bank of air cylinders outside the work area and supply air to the operators via airlines and escape SCBAs. This enables workers to operate in relative comfort for extended periods of time.
- Protect personnel by keeping them at a safe distance from the drums being opened. If personnel must be located near the drums, place explosion-resistant plastic shields between them and the drums to protect them in case of detonation. Locate controls for drum opening equipment, monitoring equipment, and fire suppression equipment behind the explosion resistant plastic shield.
- If possible, monitor continuously during opening. Place sensors of monitoring equipment, such as colorimetric tubes, dosimeters, radiation survey instruments, explosion meters, organic vapor analyzers, and oxygen meters, as close as possible to the source of contaminants, i.e., at the drum opening.
- Use the following remote-controlled devices for opening drums:
 - Pneumatically operated impact wrench to remove drum bungs.
 - Hydraulically or pneumatically operated drum piercers (see Figure 11-2).
 - Backhoes equipped with bronze spikes for penetrating drum tops in large-scale operations (see Figure 11-3).
- Do not use picks, chisels and firearms to open drums.
- Hang or balance the drum opening equipment to minimize worker exertion.
- If the drum shows signs of swelling or bulging, perform all steps slowly. Relieve excess pressure prior to opening and, if possible, from a remote location using such devices as a pneumatic impact wrench or hydraulic penetration device. If pressure must be relieved manually, place a barrier such as explosion-resistant plastic sheeting between the worker and bung to deflect any gas, liquid, or solids which may be expelled as the bung is loosened.
- Open exotic drums and polyethylene or polyvinyl chloride-lined (PVC-lined) drums through the bung by removal or drilling. Exercise extreme caution when manipulating these containers.
- Do not open or sample individual containers within laboratory packs.
- Reseal open bungs and drill openings as soon as possible with new bungs or plugs to avoid explosions and/or vapor generation. If an open drum cannot be resealed, place the drum into an overpack. Plug any openings in pressurized drums with pressure-venting caps set to a 5-psi (pounds per square inch) release to allow venting of vapor pressure.
- Decontaminate equipment after each use to avoid mixing incompatible wastes.

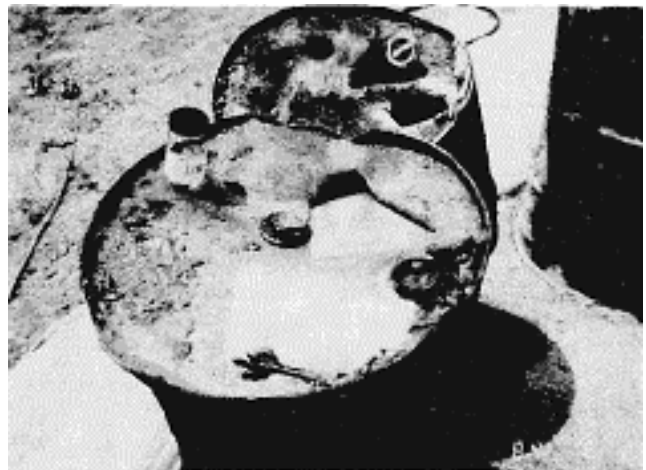

Two drums with rusted bungs were opened by backhoes with bronze spikes and now await sampling. Drum in foreground has been labeled "150" for sample documentation purposes.

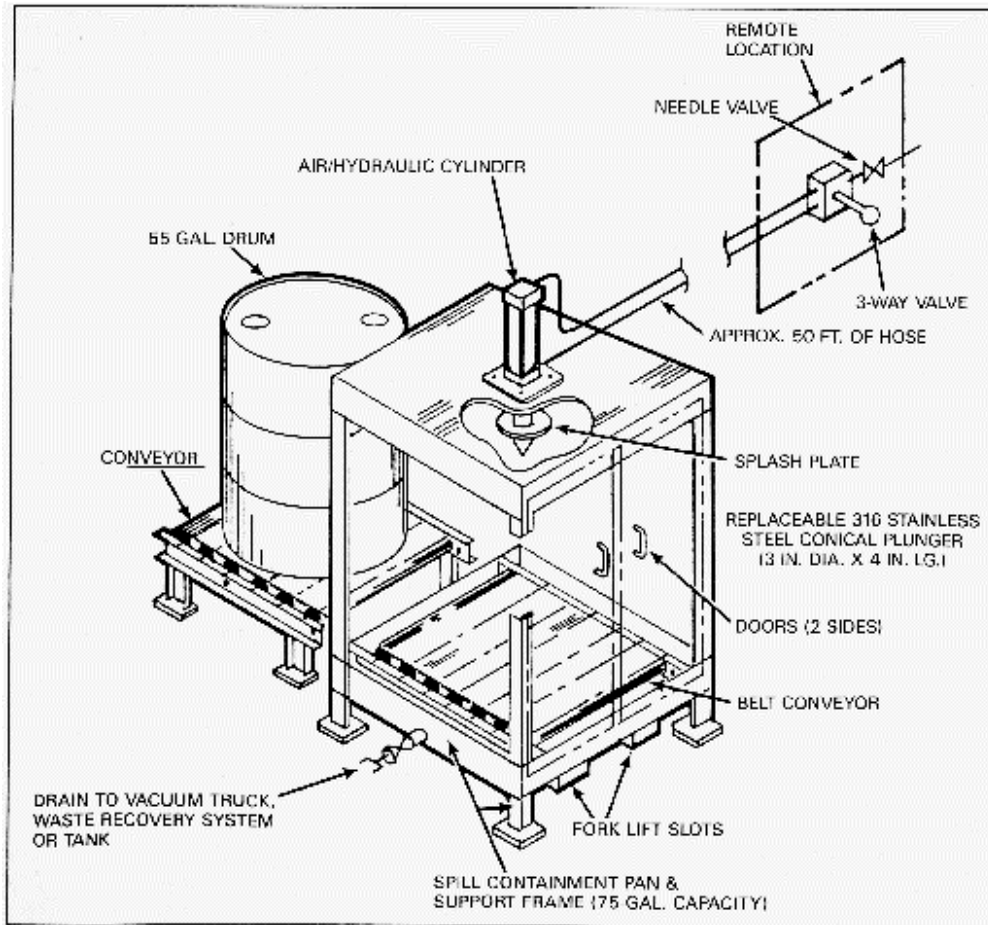

Figure 11-2. Air/Hydraulic-Operated Single-Drum Puncture Device. Source: Reference [1].

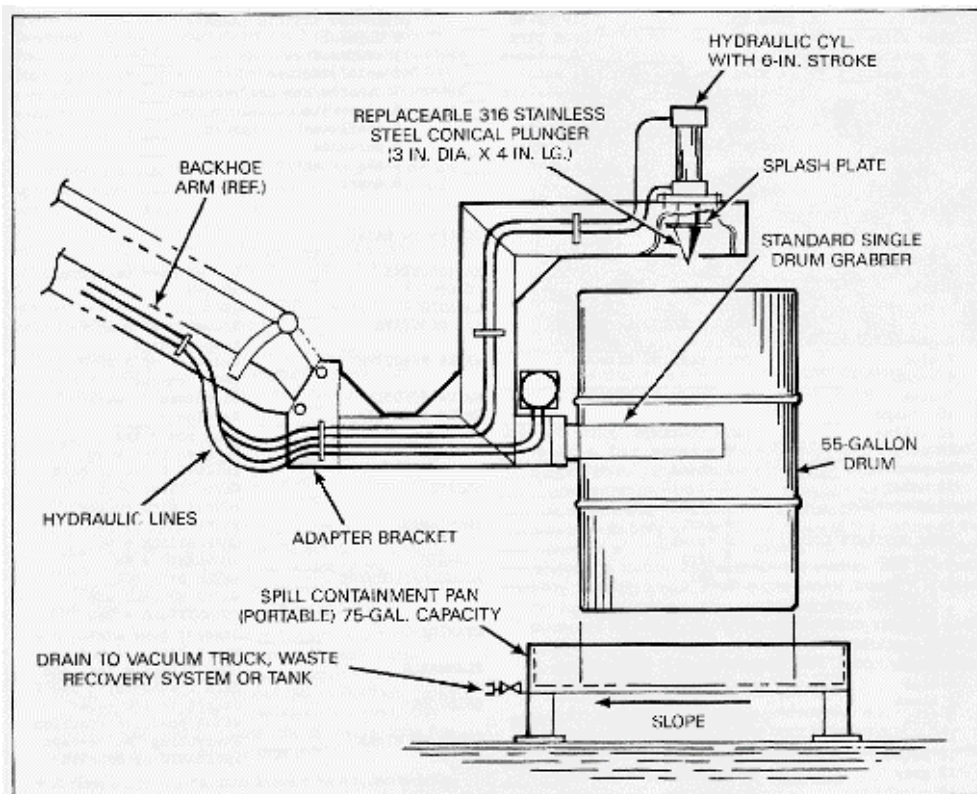

Figure 11-3. Backhoe-Mounted Drum Puncture Device. Source: Reference [1].

Sampling

Drum sampling can be one of the most hazardous activities to worker safety and health because it often involves direct contact with unidentified wastes. Prior to collecting any sample, develop a sampling plan:

- Research background information about the waste.
- Determine which drums should be sampled.
- Select the appropriate sampling device(s) and containers.
- Develop a sampling plan which includes the number, volume, and locations of samples to be taken.
- Develop Standard Operating Procedures for opening drums, sampling, and sample packaging and transportation. Some guidance in designing proper sampling procedures can be found in References [2] and [3].
- Have a trained health and safety professional determine, based on available information about the wastes and site conditions, the appropriate personal protection to be used during sampling, decontamination, and packaging of the sample.

When manually sampling from a drum, use the following techniques:

- Keep sampling personnel at a safe distance while drums are being opened. Sample only after opening operations are complete.
- Do *not* lean over other drums to reach the drum being sampled, unless absolutely necessary.
- Cover drum tops with plastic sheeting or other suitable non-contaminated materials to avoid excessive contact with the drum tops.
- *Never* stand on drums. This is extremely dangerous. Use mobile steps or another platform to achieve the height necessary to safely sample from the drums.
- Obtain samples with either glass rods or vacuum pumps. Do *not* use contaminated items such as discarded rags to sample. The contaminants may contaminate the sample and may not be compatible with the waste in the drum. Glass rods should be removed prior to pumping to minimize damage to pumps.

Characterization

The goal of characterization is to obtain the data necessary to determine how to safely and efficiently package and transport the wastes for treatment and/or disposal. If wastes are bulked, they must be sufficiently characterized to determine which of them can be safely combined (see *Bulking* later in this chapter). As a first step in obtaining these data, standard tests should be used to classify the wastes into general categories, including auto-reactives, water reactives, inorganic acids, organic acids, heavy metals, pesticides, cyanides, inorganic oxidizers, and organic oxidizers. In some cases, further analysis should be conducted to more precisely identify the waste materials. See Figure 11-4 for an example of a characterization sheet for drums.

When possible, materials should be characterized using an onsite laboratory. This provides data as rapidly as possible, and minimizes the time lag before appropriate action can be taken to handle any hazardous materials. Also, it precludes any potential problems associated with transporting samples to an offsite laboratory (e.g., sample packaging, waste incompatibility, fume generation).

If samples must be analyzed off site, samples should be packaged on site in accordance with DOT regulations (49 CFR) and shipped to the laboratory for analysis.

| | | | |
|----------------------|------------------------------|------------------------|---------------------------------|
| SITE: _____ | DRUM NO. _____ | SAMPLE NO. _____ | SCREENING RESULTS (AREA): |
| DRUM SIZE: | DRUM OPENING: | DRUM TYPE: | 0 unknown _____ |
| 0 unknown _____ | 0 unknown _____ | 0 unknown _____ | 1 radioactive _____ |
| 1 55 gal. _____ | 1 ring top _____ | 1 metal _____ | 2 acid/oxidizer _____ |
| 2 30 gal. _____ | 2 closed top _____ | 2 plastic _____ | 3 caustic/reducer/cyanide _____ |
| 3 other _____ | 3 open top _____ | 3 fiber _____ | 4 flammable organic _____ |
| specify _____ | 4 other _____ | 4 glass _____ | 5 nonflammable organic _____ |
| | specify _____ | 5 other _____ | 6 peroxide _____ |
| | | specify _____ | 7 air or water reactive _____ |
| | | | 8 inert _____ |
| DRUM COLOR: PRI SEC | DRUM CONDITION: | SCREENING DATA: | |
| 0 unknown _____ | 0 unknown _____ | | YES NO |
| 1 cream _____ | 1 good _____ | RADIOACTIVE _____ | > 1 mR over background |
| 2 clear _____ | 2 fair _____ | ACIDIC _____ | pH < 3 |
| 3 black _____ | 3 poor _____ | CAUSTIC _____ | pH > 12 |
| 4 white _____ | DRUM MARKING KEYWORD 1 _____ | AIR REACTIVE _____ | Reaction of > 10°F |
| 5 red _____ | DRUM MARKING KEYWORD 2 _____ | WATER REACTIVE _____ | temp. change |
| 6 green _____ | DRUM MARKING KEYWORD 3 _____ | WATER SOLUBLE _____ | Reaction of > 10°F |
| 7 blue _____ | DRUM CONTENTS STATE: PRI SEC | WATER BATH OVA _____ | temp. change |
| 8 brown _____ | 0 unknown _____ | COMBUSTIBLE _____ | Dissolves in water |
| 9 pink _____ | 1 solid _____ | HALIDE _____ | Reading = _____ |
| 10 orange _____ | 2 liquid _____ | INORGANIC _____ | > 10 ppm = Yes |
| 11 yellow _____ | 3 sludge _____ | ORGANIC _____ | Catches fire when |
| 12 gray _____ | 4 gas _____ | ALCOHOL/ALDEHYDE _____ | torched in water bath |
| 13 purple _____ | 5 trash _____ | CYANIDE _____ | Green flame when |
| 14 amber _____ | 6 dirt _____ | FLAMMABLE _____ | heated with copper |
| 15 green-blue _____ | 7 gel _____ | OXIDIZER _____ | WATER BATH OVA and |
| DRUM CONTENTS COLOR: | DRUM CONTENT AMOUNT: | INERT OR OTHER _____ | COMBUSTIBLE = No |
| 0 unknown _____ | 0 unknown _____ | | INORGANIC = No |
| 1 cream _____ | 1 full _____ | | WATER BATH OVA, |
| 2 clear _____ | 2 part _____ | | WATER SOLUBLE and |
| 3 black _____ | 3 empty _____ | | COMBUSTIBLE = Yes |
| 4 white _____ | CHEMICAL ANALYSIS: YES NO | | Draeger tube over |
| 5 red _____ | radiation _____ | | water bath > 2 ppm |
| 6 green _____ | ignitable _____ | | COMBUSTIBLE = Yes, and |
| 7 blue _____ | water reactive _____ | | SETA flashpoint < 140°F |
| 8 brown _____ | cyanide _____ | | Starch iodine paper |
| 9 pink _____ | oxidizer _____ | | shows positive reaction |
| 10 orange _____ | organic vapor _____ ppm | | Everything "No" except |
| 11 yellow _____ | pH _____ | | INORGANIC or ORGANIC |
| 12 gray _____ | | | |
| 13 purple _____ | | | |
| 14 amber _____ | | | |
| 15 green-blue _____ | | | |

Figure 11-4. Sample Drum Characterization Sheet. Source: EPA Region VII Emergency Planning and Response Branch. (This figure is provided only as an example. Values were selected by EPA Region VII and should be modified as appropriate.)

Staging

Although every attempt should be made to minimize drum handling, drums must sometimes be staged (i.e. moved in an organized manner to predesignated areas) to facilitate characterization and remedial action, and to protect drums from potentially hazardous site conditions (e.g., movement of heavy equipment and high temperatures that might cause explosion, ignition, or pressure buildup). Staging involves a trade-off between the increased hazards associated with drum movement and the decreased hazards associated with the enhanced organization and accessibility of the waste materials.

The number of staging areas necessary depends on sitespecific circumstances such as the scope of the operation, the accessibility of drums in their original positions, and the perceived hazards. Investigation usually involves little, if any, staging; remedial and emergency operations can involve extensive drum staging. The extent of staging must be determined individually for each site, and should always be kept to a minimum. Up to five separate areas have been used (see Figure 11-5):

- An *initial staging area* where drums can be (1) organized according to type, size, and suspected contents, and (2) stored prior to sampling.
- An *opening area* where drums are opened, sampled, and resealed. Locate this area a safe distance from the original waste disposal or storage site and from all staging areas to prevent a chain reaction in case of fire or explosion.
- During large-scale remedial or emergency tasks, a separate *sampling area* may be set up at some distance from the opening area to reduce the number of people present in the opening area, and to limit potential casualties in case of an explosion
- A *second staging area*, also known as a holding area, where drums are temporarily stored after sampling pending characterization of their contents. Do *not* place unsealed drums with unknown contents in the second staging area in case they contain incompatible materials. (Either remove the contents or overpack the drum.)
- A *final staging area*, also known as a bulking area, where substances that have been characterized are bulked for transport to treatment or disposal facilities.
 - Locate the final staging area as close as possible to the site's exit.
 - Grade the area and cover it with plastic sheeting. Construct approximately 1-foot-high (0.3-m-high) dikes around the entire area.
 - Segregate drums according to their basic chemical categories (acids, heavy metals, pesticides, etc.) as determined by characterization. Construct separate areas for each type of waste present to preclude the possibility of intermingling incompatible chemicals when bulking.

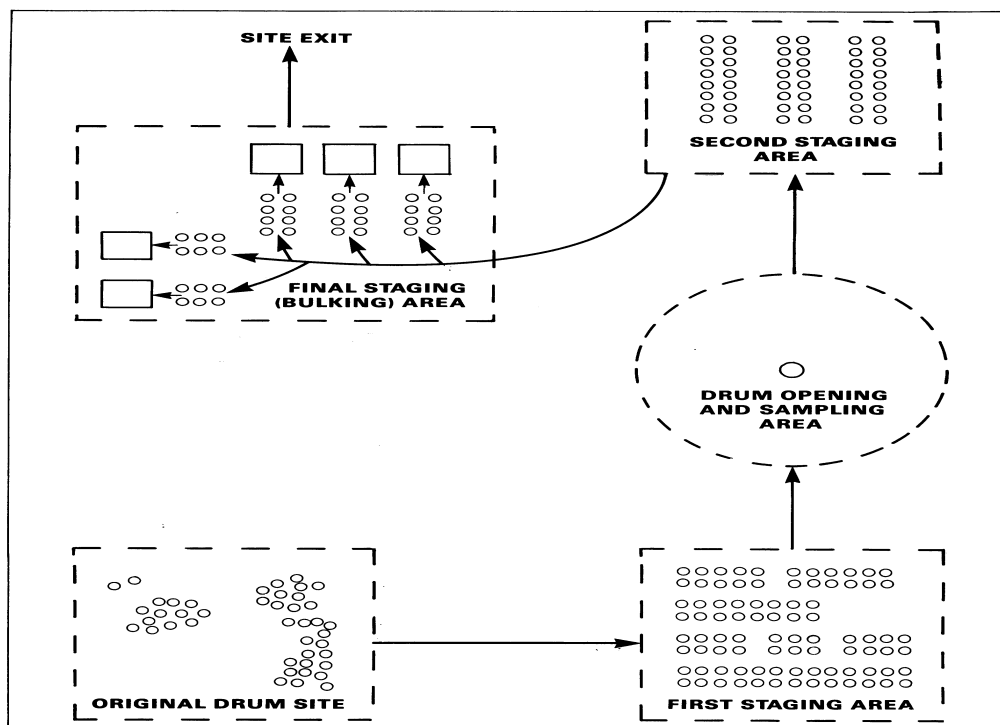

Figure 11-5. Possible Staging Areas at a Hazardous Waste Site.

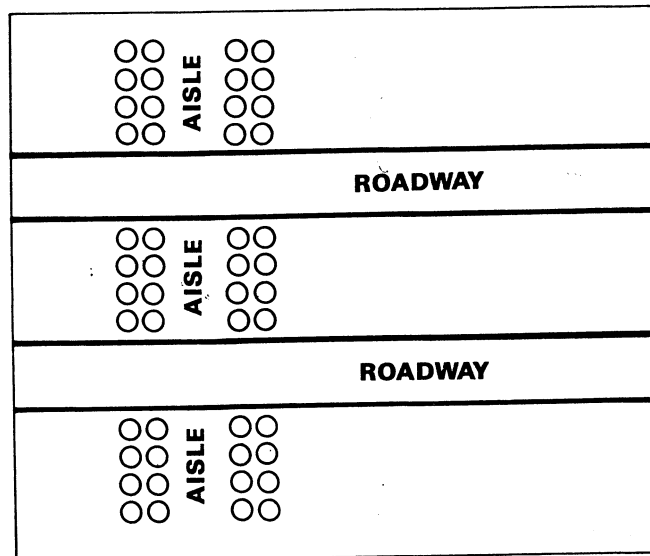

Figure 11-6. Sample Drum Staging Layout. Source: Reference [1].

Bulking

Wastes that have been characterized are often mixed together and placed in bulk containers such as tanks or vacuum trucks for shipment to treatment or disposal facilities. This increases the efficiency of transportation. Bulking should be performed only after thorough waste characterization by trained and experienced personnel. The preliminary tests described earlier under *Characterization* provide only a general indication of the nature of the individual wastes. In most cases, additional sampling and analysis to further characterize the wastes, and compatibility tests (in which small quantities of different wastes are mixed together under controlled conditions and observed for signs of incompatibility such as vapor generation and heat of reaction) should be conducted. Bulking is performed at the final staging area using the following procedures:



Crushed drums awaiting landfill. Note the staging of drums on the left in a row two drums wide.

- Inspect each tank trailer and remove any residual materials from the trailer prior to transferring any bulked materials. This will prevent reactions between incompatible chemicals.
- To move hazardous liquids, use pumps that are properly rated (see National Fire Protection Association [NFPA] 70 Articles 500-503 and NFPA 497M) and that have a safety relief valve with a splash shield. Make sure the pump hoses, casings, fittings, and gaskets are compatible with the material being pumped.
- Inspect hose lines before beginning work to ensure that all lines, fittings, and valves are intact with no weak spots.
- Take special precautions when handling hoses as they often contain residual material that can splash or spill on the personnel operating the hoses. Protect personnel against accidental splashing. Protect lines from vehicular and pedestrian traffic.
- Store flammable liquids in approved containers.

Shipment

Shipment of materials to offsite treatment, storage, or disposal facilities involves the entry of waste hauling vehicles into the site. U.S. Department of Transportation (DOT) regulations (49 CFR Parts 171-178) and EPA regulations (40 CFR Part 263) for shipment of hazardous wastes must be complied with. The following guidelines can enhance the safety of these operations:

- Locate the final staging (bulking) area as close as possible to the site exit.
- Prepare a circulation plan that minimizes conflict between cleanup teams and waste haulers. Install traffic signs, lights, and other control devices as necessary.
- Provide adequate area for onsite and hauling vehicles to turn around. Where necessary, build or improve onsite roads.
- Stage hauling vehicles in a safe area until ready for loading with drivers remaining in cab. Minimize the time that drivers spend in hazardous areas.
- Outfit the driver with appropriate protective equipment.
- If drums are shipped, tightly seal the drums prior to loading. Overpack leaking or deteriorated drums prior to shipment. (Under most circumstances, overpack drums used for hazardous wastes may not be reused [49 CFR Part 173.3(c)]). Make sure that truck bed and walls are clean and smooth to prevent damage to drums. Do not double stack drums. Secure drums to prevent shifting during transport.
- Keep bulk solids several inches below the top of the truck container. Cover loads with a layer of clean soil, foam, and/or tarp. Secure the load to prevent shifting or release during transport.
- Weigh vehicles periodically to ensure that vehicle and road weight limits are not exceeded.
- Decontaminate vehicle tires prior to leaving the site to ensure that contamination is not carried onto public roads.
- Check periodically to ensure that vehicles are not releasing dust or vapor emissions off site.
- Develop procedures for responding quickly to offsite vehicle breakdown and accidents to ensure minimal public impact.

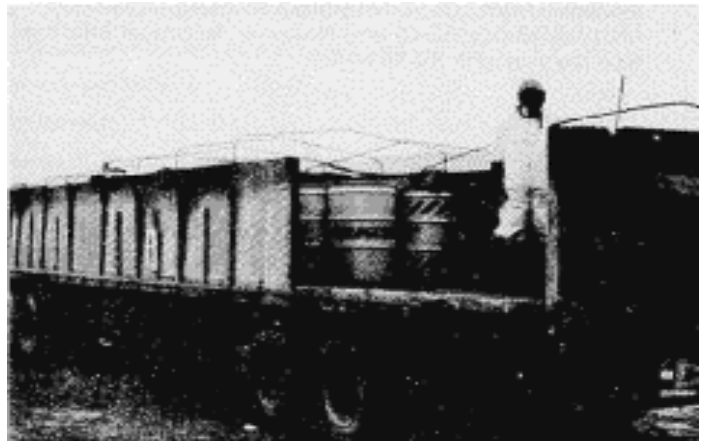

Single-stacked overpack drums awaiting transport off site. Worker suited in Level C personal protective equipment will spread a tarp over the drums to protect them during transport.

Special Case Problems

Tanks and Vaults

For tanks and vaults, which are often found on hazardous waste sites, the following procedures are recommended:

- In general, when opening a tank or vault follow the same procedures as for a sealed drum. If necessary, vent excess pressure if volatile substances are stored. Place deflecting shields

between workers and the opening to prevent direct contamination of workers by materials forced out by pressure when the tank is opened.

- Guard manholes or access portals to prevent personnel from falling into the tank.
- Identify the contents through sampling and analysis. If characterization indicates that the contents can be safely moved with the available equipment, vacuum them into a trailer for transportation to a disposal or recycling facility.
- Empty and decontaminate the tank or vault before disposal.
- If it is necessary to enter a tank or vault (i.e., confined spaces) for any reason (e.g., to clean off solid materials or sludges on the bottom or sides of the tank or vault), the following precautions should be taken [4]:
 - Ventilate thoroughly prior to entry.
 - Disconnect connecting pipelines.
 - Prior to entry, take air samples to prove the absence of flammable or other hazardous vapors and to demonstrate that adequate levels of oxygen exist.
 - Equip the entry team with appropriate respiratory protection, protective clothing, safety harnesses, and ropes.
 - Equip a safety observer with appropriate respiratory protection, protective clothing, a safety harness, and ropes.
 - Establish lifeline signals prior to entry so that the worker and safety observer can communicate by tugs on the rope.
 - Have an additional person available in the immediate vicinity to assist the safety observer if needed.
 - Instruct the safety observer not to enter the space until additional personnel are on scene.

Vacuum Trucks

- Wear appropriate protective clothing and equipment when opening the hatch.
- If possible, use mobile steps or suitable scaffolding consistent with 29 CFR Part 1910 Subpart D. Avoid climbing up the ladder and walking across the tank catwalk.
- If the truck must be climbed, raise and lower equipment and samples in carriers to enable workers to use two hands while climbing.
- If possible, sample from the top of the vehicle. If it is necessary to sample from the drain spigot, take steps to prevent spraying of excessive substances. Have all personnel stand off to the side. Have sorbent materials on hand in the event of a spill.

Elevated Tanks

In general, observe the safety precautions described for vacuum trucks. In addition:

- Use a safety line and harness.
- Maintain ladders and railings in accordance with OSHA requirements (29 CFR Part 1910 Subpart D).

Compressed Gas Cylinders

- Obtain expert assistance in moving and disposing of compressed gas cylinders.
- Handle compressed gas cylinders with extreme caution. The rupture of a cylinder may result in an explosion, and the cylinder may become a dangerous projectile.
- Record the identification numbers on the cylinders to aid in characterizing their contents.

Ponds and Lagoons

- Drowning is a very real danger for personnel suited in protective equipment because the weight of protective equipment increases an individual's overall density and severely impairs their

swimming ability. Where there is danger of drowning, provide necessary safety gear such as lifeboats, tag lines, railings, nets, safety harnesses, and flotation gear.

- Wherever possible, stay on shore. Avoid going out over the water.
- Be aware that some solid wastes may float and give the appearance of solid cracked mud. Caution should be exercised when working along shorelines.

References

1. Mayhew, Joe J.; G.M. Sodear; and D.W. Carroll. 1982. A Hazardous Waste Site Management Plan. Chemical Manufacturers Association, Inc., Washington DC.
2. deVera, E.R.; B.R Simmons; R.D. Stephens; and D.L. Storm. 1980. Samplers and Sampling Procedures for Hazardous Waste Streams. EPA-600/2-80-018. U.S. Environmental Protection Agency, Cincinnati, OH.
3. U.S. EPA. 1984. Characterization of Hazardous Waste Sites-A Methods Manual: Volume II. Available Sampling Methods. Second edition. EPA 600/ 4-84-076.
4. NIOSH. 1979. Criteria for a Recommended Standard: Working in Confined Spaces. NIOSH No. 80-106. Also available from U.S. Government Printing Office (#017-033-00353-0) and National Technical Information Service (PB-80-183015).

12. Site Emergencies

Contents

| | |
|--------------------------------------|-------|
| Introduction | 12-1 |
| Planning | 12-2 |
| Personnel | 12-3 |
| Onsite Personnel | 12-3 |
| Offsite Personnel | 12-5 |
| Federal Response Organizations | 12-5 |
| Training | 12-7 |
| Emergency Recognition and Prevention | 12-8 |
| Communications | 12-8 |
| Internal Communications | 12-8 |
| External Communications | 12-9 |
| Site Mapping | 12-10 |
| Safe Distances and Refuges | 12-10 |
| Safe Distances | 12-10 |
| Public Evacuation | 12-11 |
| Refuges (Safety Stations) | 12-11 |
| Site Security and Control | 12-12 |
| Personal Locator Systems | 12-12 |
| Evacuation Routes and Procedures | 12-13 |
| Decontamination | 12-14 |
| Equipment | 12-14 |
| Medical Treatment/First Aid | 12-17 |
| Emergency Response Procedures | 12-17 |
| Notification | 12-17 |
| Size-Up | 12-18 |
| Rescue/Response Action | 12-19 |
| Follow-Up | 12-20 |
| Documentation | 12-20 |
| References | 12-21 |

Introduction

The nature of work at hazardous waste sites makes emergencies a continual possibility, no matter how infrequently they may actually occur. Emergencies happen quickly and unexpectedly and require immediate response. At a hazardous waste site, an emergency may be as limited as a worker experiencing heat stress, or as vast as an explosion that spreads toxic fumes throughout a community. Any hazard on site can precipitate an emergency: chemicals, biologic agents, radiation or physical hazards may act alone or in concert to create explosions, fires, spills, toxic atmospheres, or other dangerous and harmful situations. Table 12-1 lists common causes of site emergencies.

Table 12-1. Causes of Emergencies at Hazardous Waste Sites

Worker-Related

- Minor accidents (slips, trips, falls).
- Chemical exposure.
- Medical problems (host stress, heat stroke, aggravation of pro-existing conditions).
- Personal protective equipment failure or source failure, tearing or permeation of protective clothing, facepiece fogging).
- Physical injury (injuries from hot or flying objects, loose clothing entangling in machinery, serious falls, vehicle accidents).
- Electrical (burns, shock, electrocution).

Waste-Related

- Fire.
- Explosion.
- Leak.
- Release of toxic vapors.
- Reaction of incompatible chemicals.
- Collapse of containers.
- Discovery of radioactive materials.

Site emergencies are characterized by their potential for complexity: uncontrolled toxic chemicals may be numerous and unidentified; their effects may be synergistic. Hazards may potentiate one another—for example, a flammable spill feeding a fire. Rescue personnel attempting to remove injured workers may themselves become victims. This variability means that advance planning, including anticipation of different emergency scenarios and thorough preparation for contingencies, is essential to protect worker and community health and safety.

This chapter outlines important factors to be considered when planning for and responding to emergencies. It defines the nature of site emergencies, lists the types of emergencies that may occur, and outlines a Contingency Plan and its components, which include personnel roles, lines of authority, training, communication systems, site mapping, site security and control, refuges, evacuation routes, decontamination, a medical program, step-by-step emergency response procedures, documentation, and reporting to outside agencies. Backup information is detailed in other chapters of the manual.

Planning

When an emergency occurs, decisive action is required. Rapidly made choices may have far-reaching, long-term consequences. Delays of minutes can create life-threatening situations. Personnel must be ready to immediately rescue or respond; equipment must be on hand and in good working order. In order to handle emergencies effectively, planning is essential. For this purpose, a Contingency Plan should be developed.

A Contingency Plan is a written document that sets forth policies and procedures for responding to site emergencies. It should incorporate the following:

- Personnel:
 - Roles.
 - Lines of authority.
 - Training.
 - Communication.

- Site:
 - Mapping.
 - Security and control.
 - Refuges.
 - Evacuation routes.
 - Decontamination stations.
- Medical/first aid.
- Equipment.
- Emergency procedures.
- Documentation.
- Reporting.

Overall, a Contingency Plan should:

- Be designed as a discrete section of the Site Safety Plan.
- Be compatible and integrated with the pollution response, disaster, fire, and emergency plans of local, state, and federal agencies.
- Be rehearsed regularly using drills and mock situations.
- Be reviewed periodically in response to new or changing site conditions or information.

Personnel

This component of the plan includes not only onsite and offsite personnel with specific emergency response roles, but also others who may be on site, such as contractors, other agency representatives, and visitors. Emergency personnel and their responsibilities are covered in detail in Chapter 3 as part of the overall organizational structure. This information is summarized in Table 12-2.

Emergency personnel may be deployed in a variety of ways. Depending on the nature and scope of the emergency, the size of the site, and the number of personnel, the emergency response cadre can include individuals, small or large teams, or several interacting teams. Although deployment is determined on a site-by-site basis, pertinent general guidelines and recommendations are listed below. In all cases the organizational structure should show a clear chain-of-command, every individual should know his or her position and authority, and the chain-of-command must be flexible enough to handle multiple emergencies, such as a rescue and a spill response or two rescues with a fire and spill response.

Onsite Personnel

The Contingency Plan should identify all individuals and teams who will participate in emergency response and define their roles. All personnel, whether directly involved in emergency response or not, should know their own responsibilities in an emergency. They must also know the names of those in authority, and the extent of that authority.

Leader

- In an emergency situation, one person must be able to assume total control and decision-making on site. This leader must:
 - Be identified in the emergency response plan. This person may be, for example, the Project Team Leader, Site Safety Officer, or Field Team Leader.
 - Be backed up by a specified alternate(s).

- Have the authority to resolve all disputes about health and safety requirements and precautions.
- Be authorized to seek and purchase supplies as necessary.
- Have control over activities of everyone entering the site, for example, contractors, fire departments, and police.
- Have the clear support of management.

Table 12-2. Personnel Involved in Emergency Response

| |
|--|
| <p>Project Team Leader</p> <ul style="list-style-type: none"> • Directs emergency response operations. • Serves as liaison with appropriate government officials. <p>Site Safety Officer</p> <ul style="list-style-type: none"> • Recommends that work be stopped if any operation threatens worker or public health or safety. • Knows emergency procedures, evacuation routes, and the appropriate telephone numbers including: the ambulance, medical facility, poison control center, fire department, and police department. • Notifies local public emergency officials. • Provides for emergency medical care on site. <p>Command Post Supervisor</p> <ul style="list-style-type: none"> • Notifies emergency support personnel by telephone or radio in case rescue operations are required. • Assists the Site Safety Officer in a rescue, if necessary. <p>Rescue Team</p> <ul style="list-style-type: none"> • An emergency rescue team stands by, partially dressed in protective gear, near the Exclusion Zone ready to rescue any workers whose health or safety is endangered. • State emergency response personnel (varies among states). <p>Decontamination Station Officers</p> <ul style="list-style-type: none"> • Perform emergency decontamination. <p>24-Hour Medical Team</p> <ul style="list-style-type: none"> • Transportation and treatment of victims by ambulance personnel, personnel at local clinics or hospitals, and physicians. <p>Communication Personnel</p> <ul style="list-style-type: none"> • Local emergency service networks provide communication links for mutual aid. • Civil Defense organizations and local radio and television stations provide information to the public during an emergency. <p>Environmental Scientists</p> <ul style="list-style-type: none"> • Predict the immediate and future movement of released hazardous substances through the geologic and hydrologic environment and air. • Assess the effect of this movement on groundwater quality, surface water quality, and air quality. • Determine the probable movement of released toxic gases. • Estimate the expected concentration of gases in the community and the expected duration of exposure. • Predict the exposure levels of people and the ecosystem to the materials. <p>Hazardous Chemicals Experts</p> <ul style="list-style-type: none"> • Provide immediate advice to those at the scene of a chemical-related emergency. <p>Firefighters</p> <ul style="list-style-type: none"> • Respond to fires that occur at a site; rescue victims. <p>Meteorologists</p> <ul style="list-style-type: none"> • Provide meteorological information needed by environmental scientists. <p>Public Safety Personnel</p> |
|--|

- The county sheriff, industrial security forces, the National Guard, and the police control site access, crowds, and traffic.

Public Evacuation Personnel

- Civil Defense organizations plan evacuations.
- The National Guard and other military, the Red Cross, the Salvation Army, and municipal transportation systems mobilize transit equipment and assist in evacuations.

On-Scene Coordinator

- Coordinates federal response activities.

Teams

Although individuals (e.g., the Site Safety Officer) may perform certain tasks in emergencies, in most cases teams provide greater efficiency and safety. Teams composed of onsite personnel may be created for specific emergency purposes, such as decontamination, rescue, and entry. Rescue teams can be used during a particularly dangerous operation, or at large sites with multiple work parties in the Exclusion Zone. Their sole function is to remain near hazardous work areas, partially dressed in protective gear, ready for full suiting and immediate rescue of any endangered worker. These teams should be capable of administering cardiopulmonary resuscitation (CPR) and emergency first aid. Other teams can be formed for responding to containment emergencies and fire-fighting until offsite assistance arrives.

Offsite Personnel

These may include individual experts such as meteorologists or toxicologists (see Table 12-2). and representatives or groups from local, state, and federal organizations offering rescue, response, or support (see Table 12-3 for a listing of typical organizations). As part of advance planning, site personnel should:

- Make arrangements with individual experts to provide guidance as needed.
- Make arrangements with the appropriate agencies (e.g., local fire department, state environmental agency, EPA regional office) for support.
- Alert these authorities to the types of emergencies that may arise.
- Determine their estimated response time and resources.
- Identify backup facilities.
- Provide training and information about hazards on site and special procedures for handling them.
- Establish a contact person and means of notification at each agency.

Federal Response Organizations

Site emergencies involving significant chemical releases should be coordinated with federal response organizations. The federal government has established a National Contingency Plan (NCP) to promote the coordination and direction of federal and state response systems, and to encourage the development of local government and private capabilities to handle chemical emergencies involving chemical releases.

To implement the NCP, a national organization was established, including a National Response Team (NRT), a network of Regional Response Teams (RRTs), a cadre of On-Scene Coordinators (OSCs), and a National Response Center (NRC). The NRC is the national terminal point for receipt of notification of significant chemical releases, and the OSCs are the interface between the onsite personnel and the federal response organizations. The OSC is the federal official responsible for ensuring that necessary response actions are taken to protect the public and the

environment from the effects at a chemical release. Many federal agencies have specific technical expertise which is available to assist the OSC.

If a significant chemical release occurs at a hazardous waste site, the National Response Center in Washington, D.C., should be contacted (Telephone: 800-424-8802). The NRC will activate federal response under the National Contingency Plan.

Table 12-3. Examples of Agencies and Groups Involved in Emergencies

| AGENCY OR GROUP | RESCUE ^a | RESCUE ^b | SUPPORT ^c |
|---|---------------------|---------------------|----------------------|
| FEDERAL | | | |
| Army Corps of Engineers | | | • |
| Coast Guard ^d | | • | • |
| Department of Defense ^d | | • | • |
| Department of Transportation | | | • |
| Environmental Protection Agency (EPA) ^d | | • | • |
| Federal Aviation Administration (FAA) | | | • |
| Federal Emergency Management Agency (FEMA) | | | • |
| National Institute for Occupational Safety and Health (NIOSH) | | | • |
| Occupational Safety and Health Administration (OSHA) | | | • |
| STATE | | | |
| Civil Defense | | | • |
| Department of Health | | | • |
| Department of Labor | | | • |
| Environmental Agency | | • | • |
| Office of the Attorney General | | | • |
| State Police | • | | • |
| LOCAL | | | |
| Ambulance and rescue services | • | • | • |
| Cleanup contractor | • | • | • |
| Disposal companies | • | • | • |
| Fire department | • | • | • |
| Hospital | | | • |
| Police | • | | • |
| Red Cross | | | • |
| Salvation Army | | | • |
| Transporters | | | • |
| Utility companies (electric, gas, water, phone) | | | • |

^aRescue = extricating and/or providing on-the-spot emergency treatment to victims.

^bResponse = controlling and stabilizing hazardous conditions.

^cSupport = providing technical assistance, equipment, and/or resources.

^dThis agency may provide an On-Scene Coordinator (OSC), depending on the jurisdiction.

Training

Since immediate, informed response is essential in an emergency, all site personnel and others entering the site (visitors, contractors, offsite emergency response groups, other agency representatives) must have some level of emergency training. Any training program should:

- Relate directly to site-specific, anticipated situations.
- Be brief and repeated often.
- Be realistic and practical.
- Provide an opportunity for special skills to be practiced regularly.
- Feature drills frequently (e.g., site-specific mock rescue operations).
- Ensure that training records are maintained in a training logbook.

Everyone entering the site must be made aware of the hazards and of hazardous actions which are forbidden or should be avoided (e.g., smoking). They must also know what to do in case of an emergency.

Visitors should be briefed on basic emergency procedures such as decontamination, emergency signals, and evacuation routes.

Personnel without defined emergency response roles (e.g., contractors, federal agency representatives) must still receive a level of training that includes at a minimum:

- Hazard recognition.
- Standard Operating Procedures.
- Signaling an emergency: the alarm used, how to summon help, what information to give and who to give it to.
- Evacuation routes and refuges.
- The person or station to report to when an alarm sounds.

Onsite emergency personnel, who have emergency roles in addition to their ordinary duties, must have a thorough understanding of emergency response. Training should be directly related to their specific roles and should include subjects such as:

- Emergency chain-of-command.
- Communication methods and signals.
- How to call for help.
- Emergency equipment and its use.
- Emergency evacuation while wearing protective equipment.
- Removing injured personnel from enclosed spaces.
- Offsite support and how to use it.

These personnel should obtain certification in first aid and CPR, and practice treatment techniques regularly, with an emphasis on:

- Recognizing and treating chemical and physical injuries.
- Recognizing and treating heat and cold stress.

Offsite emergency personnel such as local firefighters and ambulance crews often are first responders and run a risk of acute hazard exposure equal to that of any onsite worker. These personnel should be informed of ways to recognize and deal effectively with onsite hazards. Lack of information may inadvertently worsen an emergency by improper actions (e.g., spraying water on a water-reactive chemical and causing an explosion). Inadequate knowledge of the onsite

emergency chain-of-command may cause confusion and delays. Site management should, at a minimum, provide offsite emergency personnel with information about:

- Site-specific hazards.
- Appropriate response techniques.
- Site emergency procedures.
- Decontamination procedures.

Emergency Recognition and Prevention

On a day-to-day basis, individual personnel should be constantly alert for indicators of potentially hazardous situations and for signs and symptoms in themselves and others that warn of hazardous conditions and exposures. Rapid recognition of dangerous situations can avert an emergency. Before daily work assignments, regular meetings should be held. Discussion should include:

- Tasks to be performed.
- Time constraints (e.g., rest breaks, air tank changes).
- Hazards that may be encountered, including their effects, how to recognize symptoms or monitor them, concentration limits, or other danger signals.
- Emergency procedures.

After daily work assignments, a debriefing session should be held to review work accomplished and problems observed.

Communications

In an emergency, crucial messages must be conveyed quickly and accurately. Site staff must be able to communicate information such as the location of injured personnel, orders to evacuate the site, and notice of blocked evacuation routes, even through noise and confusion. Outside support sources must be reached, help obtained, and measures for public notification ensured, if necessary. To do this, a separate set of internal emergency signals should be developed and rehearsed daily. External communication systems and procedures should be clear and accessible to all workers.

Internal Communications

Internal emergency communication systems are used to alert workers to danger, convey safety information, and maintain site control. Any effective system or combination may be employed. Radios or field telephones are often used when work teams are far from the Command Post. Alarms or short clear messages can be conveyed by audible signals, e.g., bullhorns, megaphones, sirens, bells, whistles, or visual signals such as colored flags, flares, lights, and hand or whole-body movements. The primary system must have a backup. For example, hand signals may be used as a backup if radio communications fail. All internal systems should be:

- Clearly understood by all personnel.
- Checked and practiced daily.
- Intrinsically safe (spark-free).

A special set of emergency signals should be set up. These should be:

- Different from ordinary signals
- Brief and exact.

- Limited in number so that they are easily remembered.

Examples include: stop, evacuate, help, all clear. Any set of signals may be used to convey these messages as long as all personnel understand their meaning. See Table 12-4 for examples.

When designing and practicing communication systems, remember that:

- Background noise on site will interfere with talking and listening.
- Wearing personal protective equipment will impede hearing and limit vision (e.g., the ability to recognize hand and body signals).
- Inexperienced radio users may need practice in speaking clearly.

Table 12-4. Sample Internal Emergency Communication Signals

| DEVICES ^a AND SIGNALS | EXAMPLE |
|---|--|
| Radio (citizen's band or FM) | Established code words. |
| Noisemakers, including: Bell Compressed air horn Megaphone Siren Whistle | One long blast: Evacuate area by nearest emergency exit. |
| Visual signal, including: Hand signals Whole body movements | Two shot blasts: Localized problem (not dangerous to workers). |
| | Two long blasts: all clear. |
| | Hand clutching throat: Out of air/can't breath. |
| | Hands on top of head: Need assistance |
| | Thumbs up: OK/I'm alright/I understand |
| | Thumbs down: No/negative |
| | Grip partner's wrist or both hands around partner's waist: Leave area immediately. |

^aAll devices and equipment used in the Exclusion and Contamination Reduction Zones must be intrinsically safe and not capable of sparking.

External Communications

Offsite sources must be contacted to get assistance or to inform officials about hazardous conditions that may affect public or environmental safety. The telephone is the most common mode of offsite communication; phone hook-ups are considered a necessity at all but the most remote sites.

- The National Response Center (NRC) (Telephone: 800-424-8802) should be contacted in the event of a significant chemical release. The NRC will contact the appropriate federal On-Scene Coordinator.
- All personnel must be familiar with the protocol (phone number or emergency code, contact person) for contacting public emergency aid teams such as fire departments, ambulance units, and hospitals.

- If there is no site telephone system, all personnel must know the location of the nearest public telephone. A supply of telephone change and the necessary phone numbers must be readily available.

Site Mapping

Detailed information about the site is essential for advance planning. For this purpose, a site map is a valuable tool. It serves as a graphic record of the locations and types of hazards, a reference source, and a method of documentation. This map can be a duplicate of the one developed for the Site Safety Plan (see Chapter 3), but it should focus on potential areas where emergencies may develop. Pins and colored flags can be used to mark changes in personnel deployment, hazard areas, and equipment locations. The map should highlight:

- Hazard areas, especially potential IDLH conditions.
- Site terrain: topography, buildings, barriers.
- Evacuation routes.
- Site accessibility by land, sea, and air.
- Work crew locations.
- Changes (e.g., work activities, vandalism, accidents).
- Offsite populations or environments at potential risk.

The map can be used for planning and training. It can serve as a basis for developing potential emergency scenarios and alternative response strategies.

When an emergency occurs, the problem areas should be pinpointed on the map. Pertinent information such as weather and wind conditions, temperature, and forecast - should be added. The map can then be used to design the emergency plan, e.g., to define zones; determine evacuation routes; and identify emergency first-aid, decontamination, and Command Post stations. When using the map for such purposes, the accuracy of the data obtained and the potential for over or underestimating a hazard should be considered.

Even if the emergency develops so fast that the map cannot be used for on-the-spot planning, prior familiarity with it will aid in making informed decisions.

Safe Distances and Refuges

Safe Distances

No single recommendation can be given for evacuation or safe distances because of the wide variety of hazardous substances and releases found at sites. For example, a "small" chlorine leak may call for an isolation distance of only 140 feet (43 meters), while a "large" leak may require an evacuation distance of 1 mile (1.6 kilometers) or more, depending on the wind direction [1].

Safe distances can only be determined at the time of an emergency, based on a combination of site- and incident-specific factors. However, planning and outlining potential emergency scenarios will help familiarize personnel with points to consider. Factors that influence safe distances include:

- The toxicological properties of the substance.
- The physical state of the substance.

- The quantity released.
- The rate of release.
- The method of release.
- The vapor pressure of the substance.
- Vapor density relative to air.
- Wind speed and direction.
- Atmospheric stability.
- The height of release.
- Air temperature and temperature change with altitude.
- Local topography (e.g., barriers may enhance or retard a cloud or plume, and attenuate a blast).

Public Evacuation

If an incident may threaten the health or safety of the surrounding community, the public will need to be informed and possibly evacuated from the area. Site management should plan for this in coordination with the appropriate local, state and federal groups, such as the Federal Emergency Management Agency, the Civil Defense, county sheriff, local radio and television stations, municipal transportation systems, National Guard, and police.

Refuges (Safety Stations)

Onsite refuges (safety stations) can be set up for localized emergencies that do not require site evacuation. These refuges should only be used for essential needs, such as short rest breaks, emergency response strategy meetings, or temporary relief during mild cases of muscle strain and heat stress. The refuge should be located in a relatively safe, but not necessarily "clean" area, e.g., along the upwind fence line in specially cleared places or on the periphery of the Exclusion Zone.¹ The refuge should never be used for activities such as eating, drinking, or air changes. Typical items located in a refuge area include:

- A sitting/resting area that should be shaded if possible.
- Water for decontamination.
- Wind indicator.
- Communication system with the Command Post. First-aid supplies, e.g., eyewash, stretcher, blanket.
- Special monitoring devices (e.g., extra detector tubes and personal monitors).
- Bolt cutters.
- Fire extinguishers.
- Hand tools.

Other refuges can be set up in the Support Zone, or in the case of site-wide evacuations, offsite at the safe exit destination. These will provide for emergency needs such as first aid for injured personnel, clean dry clothing and wash water for chemical exposure victims, and communications with the Command Post. In a sitewide evacuation, they can be used to house evacuation exit equipment, thereby reducing security problems. These refuges should be stocked with such items as:

- Decontamination supplies.
- Oxygen and/or air.
- Water.
- Special testing equipment (e.g., pH paper, cyanide paper).

- First-aid supplies.
- Communication system.

Site Security and Control

In an emergency, the Project Team Leader (or designated representative) must know who is on site and must be able to control the entry of personnel into the hazardous areas to prevent additional injury and exposure. Only necessary rescue and response personnel should be allowed into the Exclusion Zone.

One control technique is a checkpoint or series of checkpoints through which all personnel entering or exiting the site must Pass, e.g., a Support Zone checkpoint and an Exclusion Zone checkpoint. Identification or authorization must be presented to a Checkpoint Control Manager, who records each person's:

- Name (and affiliation if offsite personnel).
- Status (in or out).
- Time of entry.
- Anticipated exit time.
- Zones or areas to be entered.
- Team or "buddy."
- Task being performed.
- Location of task.
- Protective equipment worn; air time left.
- Rescue and response equipment used.

The emergency area Checkpoint Control Manager should inform the Project Team Leader if a person remains in the emergency area beyond his or her anticipated exit time.

Personal Locator Systems

In an emergency, it is vital for the Project Team Leader (or designee) and rescue personnel to rapidly determine where workers are located and who may be injured. A passive locator system (i.e, a written record of the location of all personnel on site at any time) could be used to help find personnel in an emergency. Any such system should be:

- Graphic (such as a drawing with a written key).
- Roughly drawn to scale, with the scale and visible landmarks included.
- Kept current.
- Easy to locate.
- Stored outside the Exclusion Zone.

A good passive locator system is a site map with flags or color-headed pins identifying each worker.

Active locator systems can also be used. These are worn or carried by individual personnel, and are activated by actions such as flipping a switch, a decrease in air supply, or a fall. They have the advantage of precisely locating Individuals.

Evacuation Routes and Procedures

A severe emergency, such as a fire or explosion, may cut workers off from the normal exit near the Command Post. Therefore, alternate routes for evacuating victims and endangered personnel should be established in advance, marked, and kept clear. Routes should be directed (1) from the Exclusion Zone through an upwind Contamination Reduction Zone to the Support Zone, and (2) from the Support Zone to an offsite location in case conditions necessitate a general site evacuation. The following guidelines will help in establishing safe evacuation routes.

- Place the evacuation routes in the predominantly upwind direction of the Exclusion Zone. (At a very large site, or one with many obstacles, some exits may be placed in the downwind fence line, normally an undesirable location. If this is done, workers must know that they are not "out" until they reach the designated safety area.)
- Run the evacuation routes through the Contamination Reduction Zone. Even if there is not enough time to process the evacuees through decontamination procedures, there should be a mechanism for accounting for all personnel.
- Consider the accessibility of potential routes. Take into account obstructions such as locked gates, trenches, pits, tanks, drums, or other barriers, and the extra time or equipment needed to maneuver around or through them.
- Develop two or more routes that lead to safe areas and that are separate or remote from each other. Multiple routes are necessary in case one is blocked by a fire, spill, or vapor cloud. These routes must not overlap because if a common point were obstructed by a fire or other emergency, all intersecting routes would be blocked.
- Mark routes "safe" or "not safe" on a daily basis according to wind direction and other factors.
- Mark evacuation routes with materials such as barricade tape, flagging, or traffic cones. Equally important, mark areas that do not offer safe escape or that should not be used in an emergency, such as low ground, which can fill with gases or vapors, or routes blocked by natural barriers, such as cliffs or streams.
- Consider the mobility constraints of personnel wearing protective clothing and equipment. They will have difficulty crossing even small streams and going up and down banks.
 - Place ladders across any cut or excavation that is more than 3 feet (1 meter) deep. For long cuts, place ladders at least every 25 feet (7.5 meters), and for deep cuts, place plywood or planks on top of ladders.
 - Provide ladders for rapid descent from areas or structures elevated more than 3 feet (1 meter). Use only ladders capable of supporting a 250-lb (114-kg) load.
 - Secure ladders to prevent slipping.
 - Place standard cleated ramps ("chickenboard") across ditches and other similar obstacles. Add a railing and toe boards if the board is narrow or steeply sloped.
 - Check the toe and body clearance of ladders to make sure that personnel wearing protective clothing and SCBA can use them.
 - Check the clearance of access ports, such as crawlspaces, hatches, manholes, and tunnels to make sure that personnel wearing a protective ensemble can get through. In any case, access ports should be at least 3 feet (1 meter) in diameter where possible. (Standard tank manways are smaller.)
- Make escape routes known to all who go on site.

Decontamination

When planning for decontamination in medical emergencies, procedures should be developed for:

- Decontaminating the victim.
- Protecting medical personnel.
- Disposing of contaminated protective equipment and wash solutions.

These activities should be coordinated. The decision whether or not to decontaminate a victim is based on the type and severity of the illness or injury and the nature of the contaminant. For some emergency victims, immediate decontamination may be an essential part of life-saving first aid. For others, decontamination may aggravate the injury or delay life-saving treatment. If decontamination does not interfere with essential treatment, it should be performed. Figure 12-1 is a decision aid for emergency decontamination.

- If decontamination can be done:
 - Wash, rinse and/or cut off protective clothing and equipment.
- If decontamination cannot be done:
 - Wrap the victim in blankets, plastic, or rubber to reduce contamination of other personnel.
 - Alert emergency and offsite medical personnel to potential contamination; instruct them about specific decontamination procedures if necessary.
 - Send along site personnel familiar with the incident.

See Chapter 9, *Decontamination*, for details on decontamination techniques and procedures.

Equipment

In an emergency, equipment will be necessary to rescue and treat victims, to protect response personnel, and to mitigate hazardous conditions on site (e.g., to contain chemicals or fight fires). Some regular equipment can double for emergency use. Because of its high cost, most heavy equipment (e.g., bulldozers, drum movers, pumps) employed in emergencies will also be used for regular work assignments. All equipment should be in working order, fueled, and available when an emergency occurs. Provide safe and unobstructed access for all firefighting and emergency equipment at all times. Consider adopting the following work procedures:

- Refuel all heavy equipment when there is still one-half to one-quarter of a tank of fuel left.
- Require all equipment repairs to take place at the time the problem is discovered.
- Separate two similar pieces of equipment (e.g., two front-loaders or a bulldozer and a front-loader); park each at a different spot on site and do not use them at the same time in a hazardous area unless absolutely necessary. (This will minimize the possibility of both pieces of equipment being damaged in the same explosion or fire.)

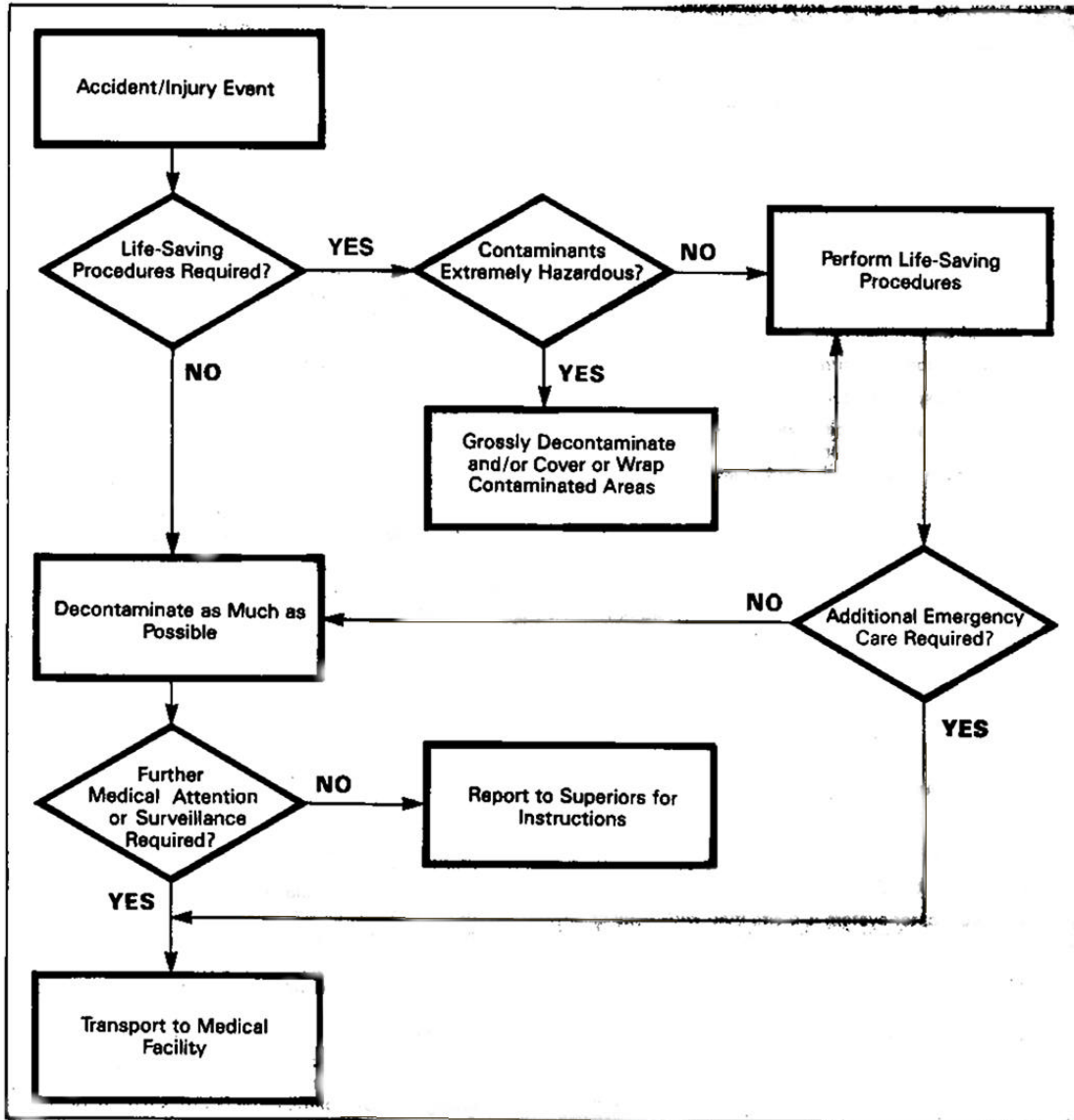

Figure 12-1. Decision Aid for Emergency Decontamination.

For personal protective equipment:

- Refill all empty self-contained breathing apparatus (SCBA) tanks and prepare them for emergencies immediately after normal use.
- Stock higher levels of protective equipment than required for anticipated hazards (e.g., a site where Level C equipment is normally used [see Table 8-6] should have Level A and B equipment available for emergencies).

Basic equipment that should be available at any site is listed in Table 12-5. Special equipment should be obtained depending on the specific types of emergencies that may occur at a particular site and the capabilities of backup offsite personnel. For example, if the nearest fire department is small and only carries one bucket of foaming solution because of its high cost and short shelf-life, a site may need to stock a large quantity of foam. When determining the type and quantity of special equipment, the following factors should be considered:

- The types of emergencies that may arise. For each emergency, consider a probable and a worst-case scenario.
- The types of hazards that site personnel may be exposed to and the appropriate containment, mitigative, and protective measures.
- The capabilities and estimated response times of offsite emergency personnel.
- The number of site personnel who could be victims during an emergency.
- The probable number of personnel available for response.

Table 12-5. Onsite Equipment and Supplies for Emergency Response

| PERSONAL PROTECTION | MEDICAL | HAZARD MITIGATION |
|---|---|--|
| <ul style="list-style-type: none"> • Escape SCBA or SCBA, which can be brought to the victim to replace or supplement his or her SCBA. • Personal protective equipment and clothing specialized for known site hazards. | <ul style="list-style-type: none"> • Air splints • Antiseptics • Blankets • Decontamination solutions appropriate for onsite chemical hazards • Emergency eye wash • Emergency showers or wash stations • Ice • Reference books containing basic first-aid procedures and information on treatment of specific chemical injuries • Resuscitator • Safety harness • Stretchers • Water, in portable containers • Wire basket litter (Stokes litter) which can be used to carry a victim in bad weather and on a difficult terrain, allows easy decontamination of the victim, and is itself easy to decontaminate | <ul style="list-style-type: none"> • Fire-fighting equipment and supplies • Spill-containment equipment, such as absorbents and oil booms • Special hazardous-use tools such as remote pneumatic impact wrenches, non-sparking wrenches and picks • Containers to hold contaminated materials. |

Medical Treatment/First Aid

In emergencies, toxic exposures and hazardous situations that cause injuries and illnesses will vary from site to site. Medical treatment may range from bandaging of minor cuts and abrasions to life-saving techniques. In many cases, essential medical help may not be immediately available. For this reason, it is vital to train onsite emergency personnel in on-the-spot treatment techniques, to establish and maintain telephone contact with medical experts (e.g., toxicologists), and to establish liaisons with local hospitals and ambulance services. Guidelines for establishing an emergency medical program are detailed in Chapter 5. When designing this program, these essential points should be included:

- Train a cadre of personnel in emergency treatment such as first aid and CPR. Training should be thorough, frequently repeated, and geared to site-specific hazards.
- Establish liaison with local medical personnel, for example: 24-hour on-call physician, medical specialists, local hospitals, ambulance service, and poison control center. Inform and educate these personnel about site-specific hazards so that they can be optimally helpful if an emergency occurs. Develop procedures for contacting them; familiarize all onsite emergency personnel with these procedures.
- Set up onsite emergency first-aid stations; see that they are well supplied and restocked immediately after each emergency.

Emergency Response Procedures

Response operations usually follow a sequence that starts with the notification of trouble and continues through the preparation of equipment and personnel for the next emergency. This process is illustrated in Figure 12-2.

Notification

Alert personnel to the emergency. Sound a site alarm to:

- Notify personnel.
- Stop work activities if necessary.
- Lower background noise in order to speed communication.
- Begin emergency procedures.

Notify onsite emergency response personnel about the emergency and include essential information:

- What happened.
- Where it happened.
- Whom it happened to.
- When it happened.
- How it happened.
- The extent of damage.
- What aid is needed.

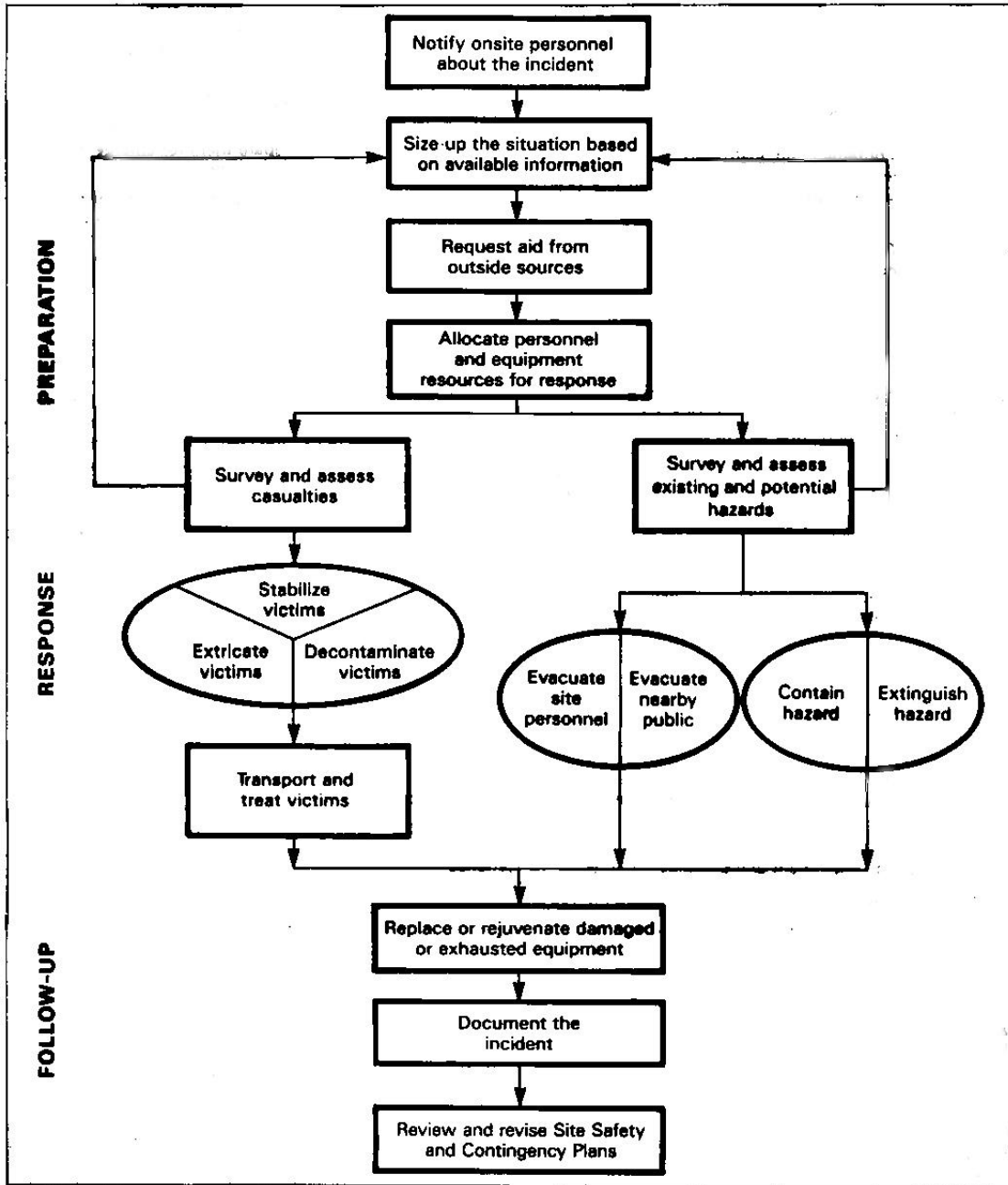

Figure 12-2. Emergency Response Operations.

Size-Up

Available information about the incident and emergency response capabilities should be evaluated. The following information should be determined, to the extent possible:

- What happened:
 - Type of incident.
 - Cause of incident.

- Extent of chemical release and transport.
- Extent of damage to structures, equipment, and terrain.
- Casualties:
 - Victims (number, location, and condition).
 - Treatment required.
 - Missing personnel.
- What could happen. Consider:
 - Types of chemicals on site.
 - Potential for fire, explosion, and release of hazardous substances.
 - Location of all personnel on site relative to hazardous areas.
 - Potential for danger to offsite population or environment.
- What can be done. Consider:
 - Equipment and personnel resources needed for victim rescue and hazard mitigation.
 - Number of uninjured personnel available for response.
 - Resources available on site.
 - Resources available from outside groups and agencies.
 - Time for outside resources to reach the site.
 - Hazards involved in rescue and response.

Rescue/Response Action

Based on the available information, the type of action required should be decided and the necessary steps implemented. Some actions may be done concurrently. No one should attempt emergency response or rescue until backup personnel and evacuation routes have been identified. Rescue/response actions may include:

- Enforce the buddy system: Allow no one to enter an, Exclusion Zone or hazardous area without a partner. At all times, personnel in the Exclusion Zone should be in line-of-sight or communications contact with the Command Post Supervisor or designee.
- Survey casualties:
 - Locate all victims and assess their condition.
 - Determine resources needed for stabilization and transport.
- Assess existing and potential hazards to site personnel and to the offsite population. Determine:
 - Whether and how to respond.
 - The need for evacuation of site personnel and offsite population.
 - The resources needed for evacuation and response.
- Allocate resources. Allocate onsite personnel and equipment to rescue and incident response operations.
- Request aid. Contact the required offsite personnel or facilities, such as the ambulance, fire department, and police.
- Control. Bring the hazardous situation under complete or temporary control; use measures to prevent the spread of the emergency.
- Extricate. Remove or assist victims from the area.
- Decontaminate. Use established procedures to decontaminate uninjured personnel in the Contamination Reduction Zone. If the emergency makes this area unsafe, establish a new decontamination area at an appropriate distance. Decontaminate victims before or after stabilization as their medical condition indicates (see Figure 12-1 for decision aid).
- Stabilize. Administer any medical procedures that are necessary before the victims can be moved. Stabilize or permanently fix the hazardous condition (e.g., repack; empty filled runoff dikes). Attend to what caused the emergency and anything (e.g., drums, tanks) damaged or endangered by the emergency.

- Transport. Take measures to minimize chemical contamination of the transport vehicle and ambulance and hospital personnel. Adequately protected rescuers should decontaminate the victims before transport. If this is not possible, cover the victims with adequate sheeting. Before transportation, determine the level of protection necessary for transport personnel. Provide them with disposable coveralls, disposable gloves, and supplied air, as necessary, for their protection. If appropriate, have response personnel accompany victims to the medical facility to advise on decontamination.
- Evacuate:
 - Move site personnel to a safe distance upwind of the incident.
 - Monitor the incident for significant changes. The hazards may diminish, permitting personnel to reenter the site, or increase and require public evacuation.
 - Inform public safety personnel when there is a potential or actual need to evacuate the offsite population. Do not attempt large-scale public evacuation. This is the responsibility of government authorities (see Table 12-3).

Follow-Up

Before normal site activities are resumed, personnel must be fully prepared and equipped to handle another emergency.

- Notify appropriate government agencies as required. For example, OSHA must be notified if there have been any fatalities or five or more hospitalizations.
- Restock all equipment and supplies. Replace or repair damaged equipment. Clean and refuel equipment for future use.
- Review and revise all aspects of the Contingency Plan according to new site conditions and lessons learned from the emergency response. When reviewing the information, consider typical questions such as:
 - Cause: What caused the emergency?
 - Prevention: Was it preventable? If so, how?
 - Procedures: Were inadequate or incorrect orders given or actions taken? Were these the result of bad judgment, wrong or insufficient information, or poor procedures? Can procedures or training be improved?
 - Site profile: How does the incident affect the site profile? How are other site cleanup activities affected?
 - Community: How is community safety affected?
 - Liability: Who is liable for damage payments?

Documentation

The Project Team Leader should initiate the investigation and documentation of the incident. This is important in all cases, but especially so when the incident has resulted in personal injury, onsite property damage, or damage to the surrounding environment. Documentation may be used to help avert recurrences, as evidence in future legal action, for assessment of liability by insurance companies, and for review by government agencies. Methods of documenting can include a written transcript taken from tape recordings made during the emergency or a bound field book (not a looseleaf book) with notes. The document must be:

- Accurate: All information must be recorded objectively.
- Authentic: A chain-of-custody procedure should be used. Each person making an entry must date and sign the document. Keep the number of documenters to a minimum (to avoid confusion and because they may have to give testimony at hearings or in court). Nothing should be erased. If details change or revisions are needed, the person making the notation should mark a horizontal line through the old material and initial the change.

- Complete: At a minimum, the following should be included:
 - Chronological history of the incident.
 - Facts about the incident and when they became available.
 - Title and names of personnel; composition of teams.
 - Actions: decisions made and by whom; orders given: to whom, by whom, and when; and actions taken: who did what, when, where, and how.
 - Types of samples and test results; air monitoring results.
 - Possible exposures of site personnel.
 - History of all injuries or illnesses during or as a result of the emergency.

Reference

1. U.S. Department of Transportation. 1984. DOT 1984 Emergency Response Guidebook. DOT P5800.3. U.S. Department of Transportation, Washington, DC.

Appendix A. List of Abbreviations and Acronyms

List of Abbreviations

| | | | |
|-----------------|------------------------------|----------------|----------------------------------|
| cm ³ | cubic centimeter | m ³ | cubic meter |
| CO ₂ | carbon dioxide | mg | milligram |
| dB _A | Decibels on A-weighted scale | ml | milliliter |
| ft | foot | mrem | milliroentgen equivalent in man |
| g | gram | O ₂ | oxygen |
| g-mole | gram-mole | psi | pounds per square inch |
| hr | hour | ppb | parts per billion |
| l | liter | ppm | parts per million |
| lb | pound | ta | ambient air temperature |
| | | ta adj | adjusted ambient air temperature |

List of Acronyms

| | | | |
|--------|---|----------|---|
| ACGIH | American Conference of Governmental Industrial Hygienists | NFPA | National Fire Protection Association |
| ANSI | American National Standards Institute | NIOSH | National Institute for Occupational Safety and Health |
| CAA | Clean Air Act | OSHA | Occupational Safety and Health Administration |
| CBC | Complete blood count | OVA | organic vapor analyzer |
| CERCLA | Comprehensive Environmental Response, Compensation, and Liability Act (also called Superfund) | PAPR | powered air-purifying respirator |
| CFR | Code of Federal Regulations | PCB | polychlorinated byphenyl |
| CGI | combustible gas indicator | PDS | personnel decontamination station |
| CNS | central nervous system | PEL | permissible exposure limit |
| CPR | cardiopulmonary resuscitation | PID | photoionization detector |
| CRC | Contamination Reduction Corridor | PPE | personal protective clothing and equipment |
| CRZ | Contamination Reduction Zone | PVC | polyvinyl chloride |
| EPA | U.S. Environmental Protection Agency | RBC | red blood count |
| ESLI | end-of-service-life indicator | REL | recommended exposure limit |
| FEF | forced expiratory flow | RV | residual volume |
| FID | flamed ionization detector | SAR | supplied-air respirator |
| FRC | functional residual capacity | SCBA | self-contained breathing apparatus |
| GC | gas chromatography | SOP | Standard Operating Procedure |
| IDLH | immediately dangerous to life or health | TLC | total lung capacity |
| IR | infrared | TLV | threshold limit value |
| LEL | lower explosive limit | TLV-C | threshold limit value – ceiling |
| LFL | lower flammable limit | TLV-STEL | threshold limit value – short-term exposure limit |
| MEFR | maximal expiratory flow rate | TWA | time-weighted average |
| MSHA | Mine Safety and Health Administration | UEL | upper explosive limit |
| MVV | maximal voluntary ventilation | UFL | upper flammable limit |
| | | USCG | U.S. Coast Guard |
| | | UV | ultraviolet |

Appendix B. Generic Site Safety Plan

This appendix provides a generic plan based on a plan developed by the U.S. Coast Guard for responding to hazardous chemical releases.¹ This generic plan can be adapted for designing a Site Safety Plan for hazardous waste site cleanup operations. It is not all inclusive and should only be used as a guide, not a standard.

A. SITE DESCRIPTION

Date _____ Location _____

Hazards _____

Area affected _____

Surrounding population _____

Topography _____

Weather conditions _____

Additional information _____

B. ENTRY OBJECTIVES - The objective of the initial entry to the contaminated area is to (describes actions, tasks to be accomplished; i.e., identify contaminated soil; monitor conditions, etc.)

C. ONSITE ORGANIZATION AND COORDINATION - The following personnel are designated to carry out the stated job functions on site. (Note: One person may carry out more than one job function.)

PROJECT TEAM LEADER _____

SCIENTIFIC ADVISOR _____

SITE SAFETY OFFICER _____

PUBLIC INFORMATION OFFICER _____

SECURITY OFFICER _____

RECORDKEEPER _____

FINANCIAL OFFICER _____

FIELD TEAM LEADER _____

FIELD TEAM MEMBERS _____

FEDERAL AGENCY REPS (i.e., EPA, NIOSH) _____

¹ U.S. Coast Guard. Policy Guidance for Response to Hazardous Chemical Releases, USCG Pollution Response COMDTINST-MI6465.30.

STATE AGENCY REPS _____

LOCAL AGENCY REPS _____

CONTRACTOR(S) _____

All personnel arriving or departing the site should log in and out with the Record-keeper. All activities on site must be cleared through the Project Team Leader.

D. ONSITE CONTROL

(Name of individual or agency) has been designated to coordinate access control and security on site. A safe perimeter has been established at (distance or description of controlled area) _____

No unauthorized person should be within this area.

The onsite Command Post and staging area have been established at _____

The prevailing wind conditions are _____. This location is upwind from the Exclusion Zone.

Control boundaries have been established, and the Exclusion Zone (the contaminated area), hotline, Contamination Reduction Zone, and Support zone (clean area) have been identified and designated as follows: (describe boundaries and/or attach map of controlled area) _____

These boundaries are identified by: (marking of zones, i.e., red boundary tape - hotline; traffic cones - Support Zone; etc*) _____

E. HAZARD EVALUATION

The following substances) are known or suspected to be on site. The primary hazards of each are identified.

| <u>Substances Involved</u> | <u>Concentrations (If Known)</u> | <u>Primary Hazards</u> |
|----------------------------|----------------------------------|----------------------------------|
| (chemical name) _____ | _____ | (e.g., toxic on nhalation) _____ |
| _____ | _____ | _____ |
| _____ | _____ | _____ |

The following additional hazards are expected on site: (i.e., slippery ground, uneven terrain, etc.) _____

Hazardous substance information form(s) for the involved substances) have been completed and are attached.

F. PERSONAL PROTECTIVE EQUIPMENT

Based on evaluation of potential hazards, the following levels of personal protection have been designated for the applicable work areas or tasks:

| <u>Location</u> | <u>Job Function</u> | <u>Level of Protection</u> | | | | |
|------------------------------|---------------------|----------------------------|---|---|---|-------|
| Exclusion zone | _____ | A | B | C | D | Other |
| | _____ | A | B | C | D | Other |
| | _____ | A | B | C | D | Other |
| | _____ | A | B | C | D | Other |
| Contamination Reduction zone | _____ | A | B | C | D | Other |
| | _____ | A | B | C | D | Other |
| | _____ | A | B | C | D | Other |
| | _____ | A | B | C | D | Other |

Specific protective equipment for each level of protection is as follows:

| | | | |
|----------------|---|----------------|--|
| Level A | <u>Fully-encapsulating suit SCBA (disposable coveralls)</u> _____ _____ | Level C | <u>Splash gear (type)</u> <u>Full-face canister resp.</u> _____ _____ |
| Level B | <u>Splash gear (type)</u> <u>SCBA</u> _____ _____ | Level D | _____ _____ _____ |
| Other | _____ _____ _____ _____ _____ | | |

The following protective clothing materials are required for the involved substances:

| Substance | Material |
|-----------------------|------------------------------------|
| (chemical name) _____ | (material name, e.g., Viton) _____ |
| _____ | _____ |
| _____ | _____ |
| _____ | _____ |

If air-purifying respirators are authorized, (filtering medium) . is the appropriate canister for use with the involved substances and concentrations. A competent individual has determined that all criteria for using this type of respiratory protection have been met.

NO CHANGES TO THE SPECIFIED LEVELS OF PROTECTION SHALL BE MADE WITHOUT THE APPROVAL OF THE SITE SAFETY OFFICER AND THE PROJECT TEAM LEADER.

G. ONSITE WORK PLANS

Work party(s) consisting of ____ persons will perform the following tasks:

Project Team Leader _____ (name) _____ (function)

Work Party #1 _____

Work Party #2 _____

Rescue Team _____
(required for
entries to IDLH
environments)

**Decontamination
Team** _____

The work party(s) were briefed on the contents of this plan at _____

H. COMMUNICATION PROCEDURES

Channel _____ has been designated as the radio frequency for personnel in the Exclusion Zone. All other onsite communications will use channel _____.

Personnel in the Exclusion zone should remain in constant radio communication or within sight of the Project Team Leader. Any failure of radio communication requires an evaluation of whether personnel should leave the Exclusion zone.

(Horn blast, siren, etc.) _____ is the emergency signal to indicate that all personnel should leave the Exclusion zone. In addition, a loud hailer is available if required.

The following standard hand signals will be used in case of failure of radio communications:

- Hand gripping throat ----- Out of air, can't breathe
- Grip partner's wrist or ----- Leave area immediately
both hands around waist
- Hands on top of head ----- Need assistance
- Thumbs up ----- OK, I am all right, I understand
- Thumbs down ----- No, negative

Telephone communication to the Command Post should be established as soon as practicable. The phone number is _____.

I. DECONTAMINATION PROCEDURES

Personnel and equipment leaving the Exclusion zone shall be thoroughly decontaminated. The standard level decontamination protocol shall be used with the following decontamination stations: (1) _____ (2) _____ (3) _____ (4) _____ (5) _____ (6) _____ (7) _____ (8) _____ (9) _____ (10) _____ Other _____

Emergency decontamination will include the following stations:

The following decontamination equipment is required:

(Normally detergent and water) will be used as the decontamination solution.

J. SITE SAFETY AND HEALTH PLAN

1. _____ (name) is the designated Site Safety Officer and is directly responsible to the Project Team Leader for safety recommendations on site.

2. Emergency Medical Care

(names of qualified personnel) _____ are the qualified EMTS on site. (medical facility names) at (address), phone _____ is located _____ minutes from this location (name of person) was contacted at (time) and briefed on the situation, the potential hazards, and the substances involved. A map of alternative routes to this facility is available at (normally Command Post).

Local ambulance service is available from _____ at phone _____. Their response time is _____ minutes. Whenever possible arrangements should be made for onsite standby.

First-aid equipment is available on site at the following locations:

- First-aid kit _____
- Emergency eye wash _____
- Emergency shower _____
- (other) _____

Emergency medical information for substances present:

| <u>Substance</u> | <u>Exposure Symptoms</u> | <u>First-Aid Instructions</u> |
|------------------|--------------------------|-------------------------------|
| _____ | _____ | _____ |
| _____ | _____ | _____ |
| _____ | _____ | _____ |

List of emergency phone numbers:

| <u>Agency/Facility</u> | <u>Phone</u> | <u>Contact</u> |
|-----------------------------|--------------|----------------|
| Police _____ | _____ | _____ |
| Fire _____ | _____ | _____ |
| Hospital _____ | _____ | _____ |
| Airport _____ | _____ | _____ |
| Public Health Advisor _____ | _____ | _____ |

3. Environmental Monitoring

The following environmental monitoring instruments shall be used on site (cross out if not applicable) at the specified intervals.

| | |
|-------------------------------------|--------------------------------------|
| Combustible Gas Indicator | -continuous/hourly/daily/other _____ |
| O ₂ Monitor | -continuous/hourly/daily/other _____ |
| Colorimetric Tubes- (type) _____ | -continuous/hourly/daily/other _____ |
| _____ | _____ |
| _____ | _____ |
| HNU/OVA | -continuous/hourly/daily/other _____ |
| Other _____ | -continuous/hourly/daily/other _____ |
| _____ | -continuous/hourly/daily/other _____ |

4. Emergency Procedures (should be modified as required for incident)

The following standard emergency procedures will be used by onsite personnel. The Site Safety Officer shall be notified of any onsite emergencies and be responsible for ensuring that the appropriate procedures are followed.

Personnel Injury in the Exclusion Zone: Upon notification of an injury in the Exclusion Zone, the designated emergency signal _____ shall be sounded. All site personnel shall assemble at the decontamination line. The rescue team will enter the Exclusion Zone (if required) to remove the injured person to the hotline. The Site Safety Officer and Project Team Leader should evaluate the nature of the injury, and the affected person should be decontaminated to the extent possible prior to movement to the Support Zone. The onsite EMT shall initiate the appropriate first aid, and contact should be made for an ambulance and with the designated medical facility (if required). No persons shall reenter the Exclusion Zone until the cause of the injury or symptoms is determined.

Personnel Injury in the Support Zone: Upon notification of an injury in the Support Zone, the Project Team Leader and Site Safety Officer will assess the nature of the injury. If the cause of the injury or loss of the injured person does not affect the performance of site personnel, operations may continue, with the onsite EMT initiating the appropriate increases the risk to others, the designated emergency signal _____ shall be sounded and all site personnel shall move to the decontamination line for further instructions. Activities on site will stop until the added risk is removed or minimized.

Fire/Explosion: Upon notification of a fire or explosion on site, the designated emergency signal _____ shall be sounded and all site personnel assembled at the decontamination line. The fire department shall be alerted and all personnel moved to a safe distance from the involved area.

Personal Protective Equipment Failure: If any site worker experiences a failure or alteration of protective equipment that affects the protection factor, that person and his/her buddy shall immediately leave the Exclusion Zone. Reentry shall not be permitted until the equipment has been repaired or replaced.

Other Equipment Failure: If any other equipment on site fails to operate properly, the Project Team Leader and Site Safety Officer shall be notified and then determine the effect of this failure on continuing operations on site, If the failure affects the safety of personnel or prevents completion of the Work Plan tasks, all personnel shall leave the Exclusion Zone until the situation is evaluated and appropriate actions taken.

The following emergency escape routes are designated for use in those situations where egress from the Exclusion Zone cannot occur through the decontamination line: (describe alternate routes to leave area in emergencies)

Appendix C. Sample Hazardous Substance Information Form

COMMON NAME: _____ **CHEMICAL NAME:** _____

I. PHYSICAL/CHEMICAL PROPERTIES

| | Source |
|--|---------------|
| Natural physical state: Gas _____ Liquid _____ Solid _____ (at ambient temps of 20°C-25°C) | |
| Molecular weight _____ g/g-mole | |
| Density ^a _____ °F/°C | |
| Specific gravity ^a _____ @ _____ °F/°C | |
| Solubility: water _____ @ _____ °F/°C | |
| Solubility ^b : _____ @ _____ °F/°C | |
| Melting point _____ °F/°C | |
| Vapor pressure _____ mmHg @ _____ °F/°C | |
| Vapor density _____ @ _____ °F/°C | |
| Flash point _____ °F/°C (open cup _____; closed cup _____) | |
| Other: _____ | |

II. HAZARDOUS CHARACTERISTICS

| A. TOXICOLOGICAL HAZARD | HAZARD? | CONCENTRATIONS (PEL, TLV, other) | SOURCE |
|-------------------------|---------|-------------------------------------|--------|
| Inhalation | Yes No | _____ | _____ |
| Ingestion | Yes No | _____ | _____ |
| Skin/eye absorption | Yes No | _____ | _____ |
| Skin/eye contact | Yes No | _____ | _____ |
| Carcinogenic | Yes No | _____ | _____ |
| Teratogenic | Yes No | _____ | _____ |
| Mutagenic | Yes No | _____ | _____ |
| Aquatic | Yes No | _____ | _____ |
| Other: _____ | Yes No | _____ | _____ |

| B. TOXICOLOGICAL HAZARD | HAZARD? | CONCENTRATIONS (PEL, TLV, other) | SOURCE |
|-------------------------------|---------|-------------------------------------|--------|
| Combustibility | Yes No | _____ | _____ |
| Toxic byproduct (s): _____ | Yes No | _____ | _____ |
| Flammability | Yes No | _____ | _____ |
| LFL | | _____ | _____ |
| UFL | | _____ | _____ |
| Explosivity | Yes No | _____ | _____ |
| LFL | | _____ | _____ |
| UFL | | _____ | _____ |

^aOnly one is necessary.

^bFor organic compounds, recovery of spilled material by solvent extraction may require solubility data.

| | | | |
|-----------------------------|--------------------------|-----------------------|---------------|
| C. REACTIVITY HAZARD | HAZARD? Yes No | CONCENTRATIONS | SOURCE |
| Reactivities: | | | |
| _____ | | _____ | _____ |
| _____ | | _____ | _____ |

| | | | |
|------------------------------|--------------------------|-----------------------|---------------|
| D. CORROSIVITY HAZARD | HAZARD? Yes No | CONCENTRATIONS | SOURCE |
| Ph _____ | | | |
| Neutralizing agent: | | | |
| _____ | | _____ | _____ |
| _____ | | _____ | _____ |

| | | | |
|------------------------------|----------------|-----------------------|---------------|
| E. RADIOACTIVE HAZARD | HAZARD? | CONCENTRATIONS | SOURCE |
| Background | Yes No | _____ | _____ |
| Alpha particles | Yes No | _____ | _____ |
| Beta particles | Yes No | _____ | _____ |
| Gamma radiation | Yes No | _____ | _____ |

III. DESCRIPTION OF INCIDENT:

Quantity involved _____

Release information _____

Monitoring/sampling recommended _____

IV. RECOMMENDED PROTECTION:

Worker _____

Public _____

V. RECOMMENDED SITE CONTROL:

Hotline _____

Decontamination line _____

Command Post location _____

VI. REFERENCES FOR SOURCES:

SAMPLE HAZARDOUS SUBSTANCE INFORMATION FORM FILLED OUT FOR VINYL CHLORIDE

COMMON NAME: Vinyl Chloride CHEMICAL NAME: Chloroethene

I. PHYSICAL/CHEMICAL PROPERTIES

| | | SOURCE |
|--|------------------------------|----------|
| Natural physical state: Gas <input checked="" type="checkbox"/> Liquid <input type="checkbox"/> Solid <input type="checkbox"/> | | CHRIS |
| (at ambient temps of 20°C-25°C) | | |
| Molecular weight | <u>62.5</u> g/g-mole | CHRIS |
| Density ^a | | |
| Specific gravity ^a | <u>0.9121 @ 20 °P/°C</u> | CHEM DIC |
| Solubility: water | <u>slightly @ — °P/°C</u> | CHEM DIC |
| Solubility ^b : <u>alcohol</u> | <u>soluble @ — °P/°C</u> | CHEM DIC |
| Boiling point | <u>7.2 °P/°C</u> | CHRIS |
| Melting point | <u>-244.8 °P/°C</u> | CHRIS |
| Vapor pressure | <u>2,300 mmHg @ 20 °P/°C</u> | CHEM DIC |
| Vapor density | <u>2.2 @ — °P/°C</u> | NFPA |
| Flash point | <u>-110 °P/°C</u> | CHRIS |
| (open cup <input checked="" type="checkbox"/> ; closed cup <input type="checkbox"/>) | | |
| Other: <u>Polymerizes readily in air and water</u> | | OHMTADS |

II. HAZARDOUS CHARACTERISTICS

| A. TOXICOLOGICAL HAZARD | HAZARD? | CONCENTRATIONS (PEL, TLV, other) | SOURCE |
|--|---|-------------------------------------|-------------------|
| Inhalation | <input checked="" type="radio"/> Yes No | <u>PEL-TWA 1 ppm/TLV-TWA 5 ppm</u> | <u>OSHA/ACGIH</u> |
| Ingestion | <input type="radio"/> Yes No | | |
| Skin/eye absorption | <input checked="" type="radio"/> Yes No | | <u>SITTIG</u> |
| Skin/eye contact | <input checked="" type="radio"/> Yes No | <u>SKIN burn from contact</u> | <u>OHMTADS</u> |
| Carcinogenic | <input checked="" type="radio"/> Yes No | <u>TLV 5 ppm/PEL 1 ppm</u> | <u>ACGIH/OSHA</u> |
| Teratogenic | <input type="radio"/> Yes No | | |
| Mutagenic | <input type="radio"/> Yes No | | |
| Aquatic | <input type="radio"/> Yes No | | |
| Other: _____ | <input type="radio"/> Yes No | | |
| B. TOXICOLOGICAL HAZARD | HAZARD? | CONCENTRATIONS | SOURCE |
| Combustibility | <input checked="" type="radio"/> Yes No | | |
| Toxic byproduct(s): <u>Hydrogen chloride</u> <u>Phosgene, carbon monoxide</u> | <input checked="" type="radio"/> Yes No | | |
| Flammability | <input checked="" type="radio"/> Yes No | | |
| LPL | | <u>3.6</u> | <u>OHMTADS</u> |
| UPL | | <u>33</u> | <u>OHMTADS</u> |
| Explosivity | <input type="radio"/> Yes No | | |
| LEL | | | |
| UEL | | | |

^aOnly one is necessary.

^bFor organic compounds, recovery of spilled material by solvent extraction may require solubility data.

| | | | |
|--|--|----------------|--------------|
| C. REACTIVITY HAZARD | HAZARD? <input checked="" type="radio"/> Yes <input type="radio"/> No | CONCENTRATIONS | SOURCE |
| Reactivities: <u>Polymerizes in air, sunlight or heat</u> | | _____ | <u>CHRIS</u> |
| D. CORROSIVITY HAZARD | HAZARD? Yes <input checked="" type="radio"/> No | CONCENTRATIONS | SOURCE |
| ph _____ Neutralizing agent: _____ | | _____ | _____ |
| E. RADIOACTIVE HAZARD | HAZARD? | EXPOSURE RATE | SOURCE |
| Background | Yes <input checked="" type="radio"/> No | _____ | _____ |
| Alpha particles | Yes <input checked="" type="radio"/> No | _____ | _____ |
| Beta particles | Yes <input checked="" type="radio"/> No | _____ | _____ |
| Gamma radiation | Yes <input checked="" type="radio"/> No | _____ | _____ |

III. DESCRIPTION OF INCIDENT:

Quantity involved 1,000 lbs
 Release information Suspected Leaking Cylinder

 Monitoring/sampling recommended _____

IV. RECOMMENDED PROTECTION:

Worker Level B protection. Protective clothing materials
recommended: CPE or Viton

 Public _____

V. RECOMMENDED SITE CONTROL:

Hotline _____

 Decontamination line _____

 Command Post location _____

VI. REFERENCES FOR SOURCES:

- CHRIS - Chemical Hazards Response Information System Manual II
- ACGIH - TLVs - Threshold Limit Values for Chemical Substances
and Physical Agents in the Work Environment 1984-85
- CHEM DIG - Condensed Chemical Dictionary, Tenth Edition, 1981
- NEPA - Fire Protection Guide on Hazardous Materials, Seventh Ed., 1978
- OHMTADS - Oil and Hazardous Materials Technical Assistance Data System, EPA 1984
- SITIG - Handbook of Toxic and Hazardous Chemicals, Marshall Sittig, 1981
- OSHA - 29 CFR Part 1910.1017

Appendix D. Sample Decontamination Procedures for Three Typical Levels of Protection^a

F.S.O.P. No. 7

Process: DECONTAMINATION PROCEDURES

INTRODUCTION

- 1.1 The objective of these procedures is to minimize the risk of exposure to hazardous substances. These procedures were derived from the U.S. Environmental Protection Agency, Office of Emergency and Remedial Response's (OERR), 'Interim Standard Operating Safety Guides (revised Sep. 82)". This version of the guides is in a format that is more appropriate for use in the field.
- 1.2 Protective equipment must be worn by personnel when response activities involve known or suspected hazardous substances. The procedures for decontaminating personnel upon leaving the contaminated area are addressed for each of the EPA, OERR designated levels of protection. The procedures given are for the maximum and minimum amount of decontamination used for each level of protection.
- 1.3 The maximum decontamination procedures for all levels of protection consist of specific activities at nineteen stations. Each station emphasizes an important aspect of decontamination. When establishing a decontamination line, each aspect should be incorporated separately or combined with other aspects into a procedure with fewer steps (such as the Minimum Decontamination Procedures).
- 1.4 Decontamination lines are site specific since they are dependent upon the types of contamination and the type of work activities on site. A cooling station is sometimes necessary within the decontamination line during hot weather. It is usually a location in a shaded area in which the wind can help to cool personnel. In addition, site conditions may permit the use of cooling devices such as cool water hose, ice packs, cool towels, etc. When the decontamination line is no longer required, contaminated wash and rinse solutions and contaminated articles must be contained and disposed of as hazardous wastes in compliance with state and federal regulations.

^a Source: Excerpted from Field Standard Operating Procedures for the Decontamination of Response Personnel (FSOP 7). EPA Office of Emergency and Remedial Response, Hazardous Response Support Division, Washington, DC. January 1985.

PROCESS DECON PROCEDURES

MAXIMUM DECONTAMINATION LAYOUT

LEVEL A PROTECTION

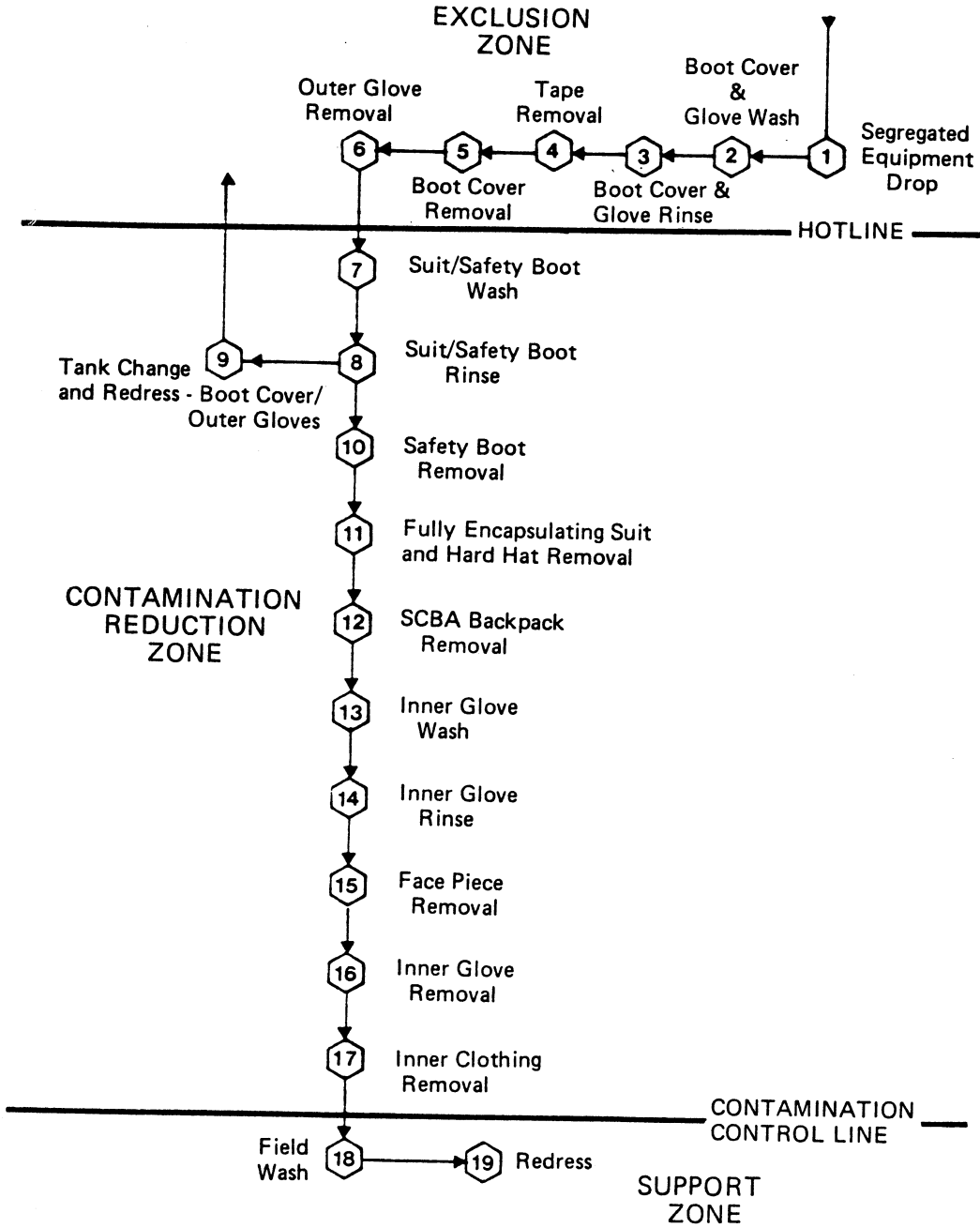

PROCESS DECON PROCEDURES

MAXIMUM DECONTAMINATION LAYOUT

LEVEL B PROTECTION

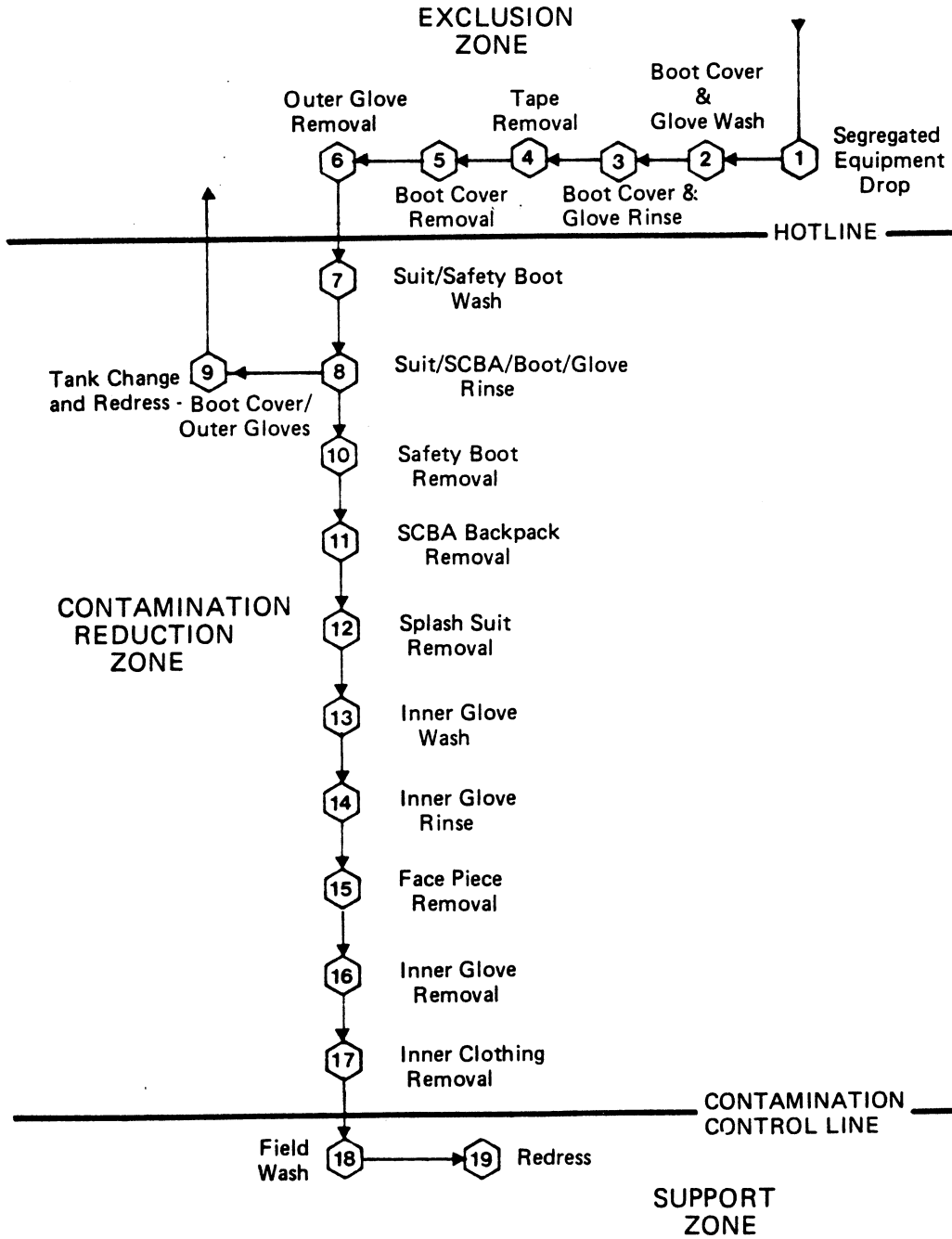

PROCESS DECON PROCEDURES

MAXIMUM DECONTAMINATION LAYOUT

LEVEL C PROTECTION

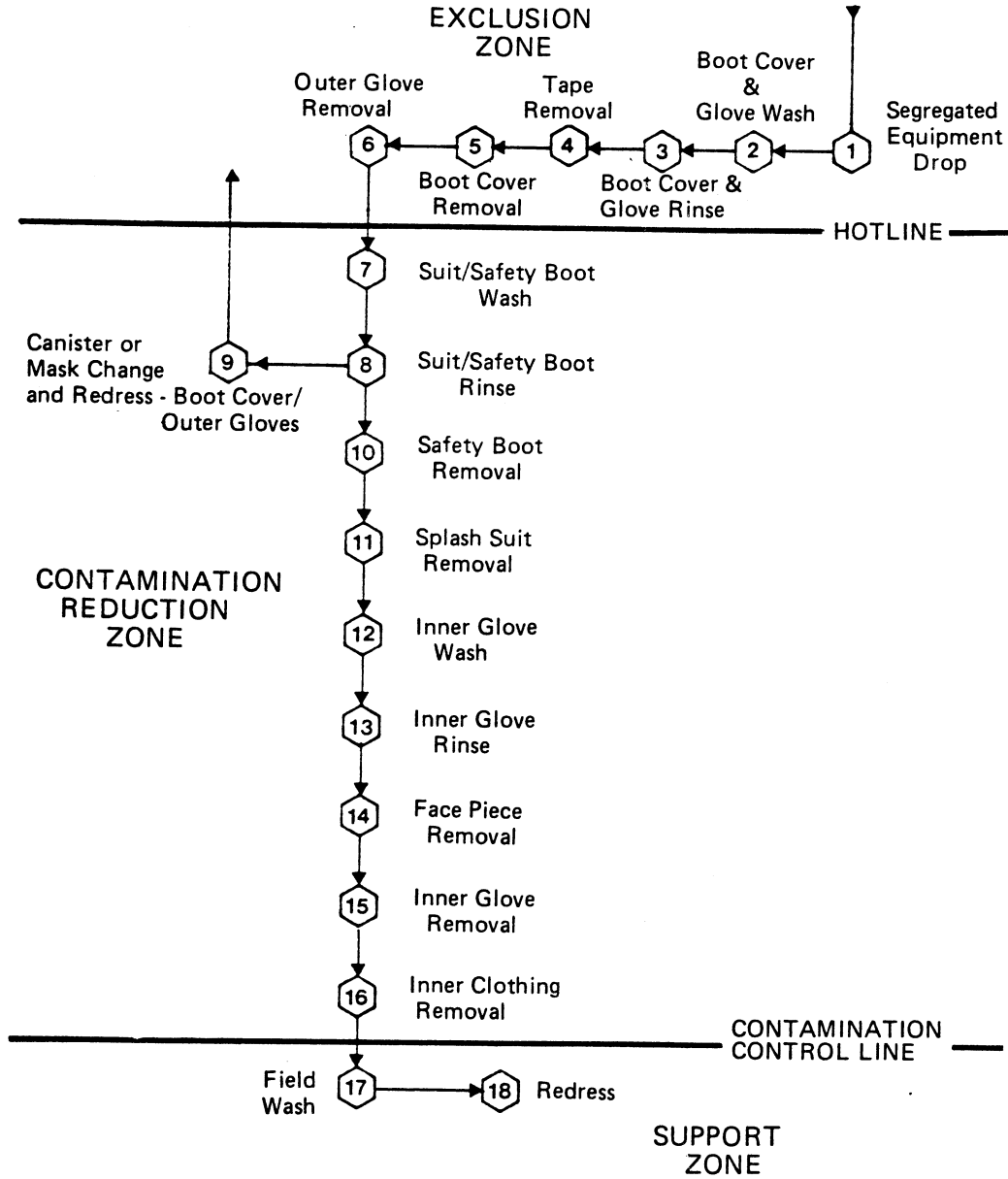

PROCESS DECON PROCEDURES

MINIMUM DECONTAMINATION LAYOUT

LEVELS A & B PROTECTION

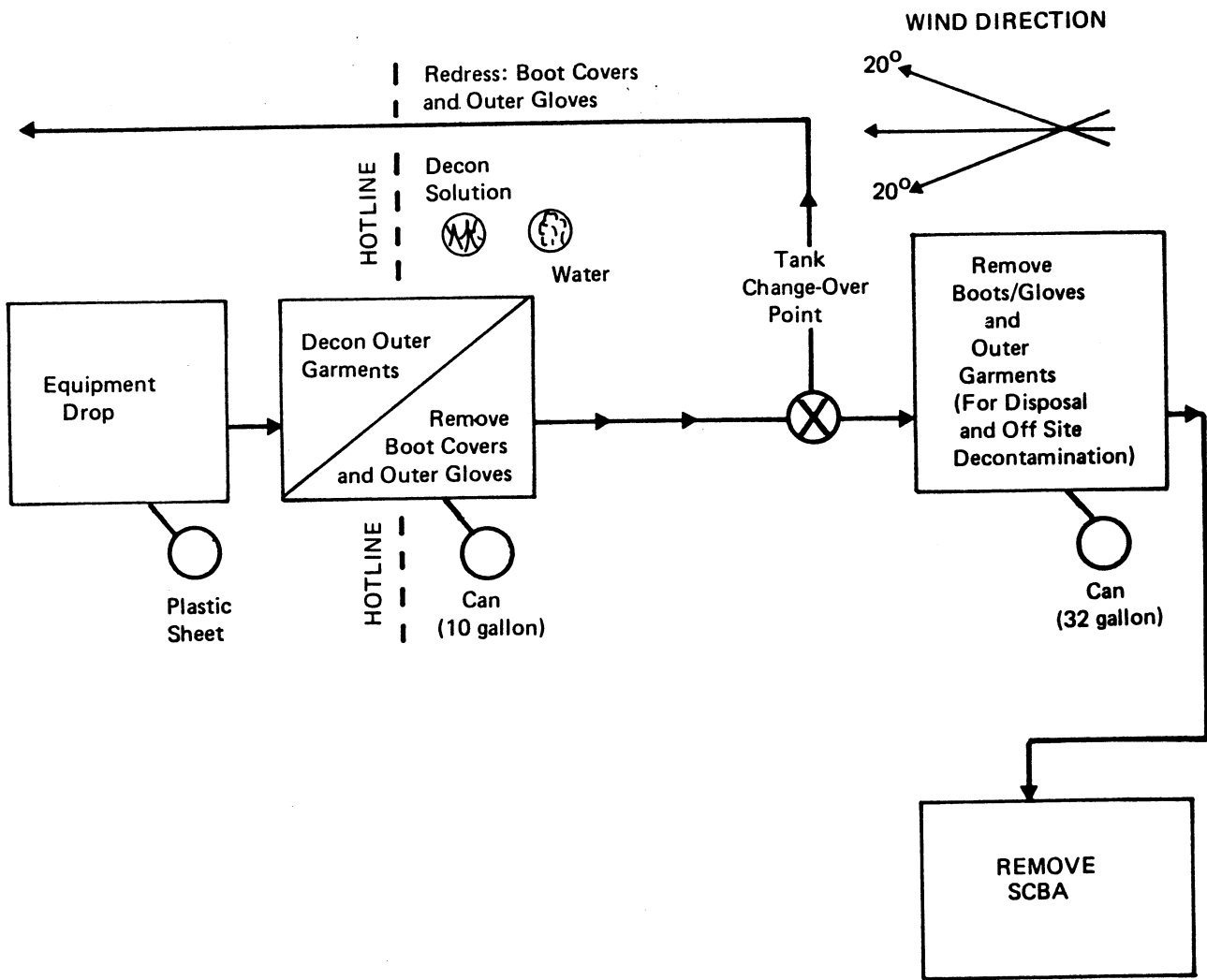

PROCESS DECON PROCEDURES

MINIMUM DECONTAMINATION LAYOUT

LEVEL C PROTECTION

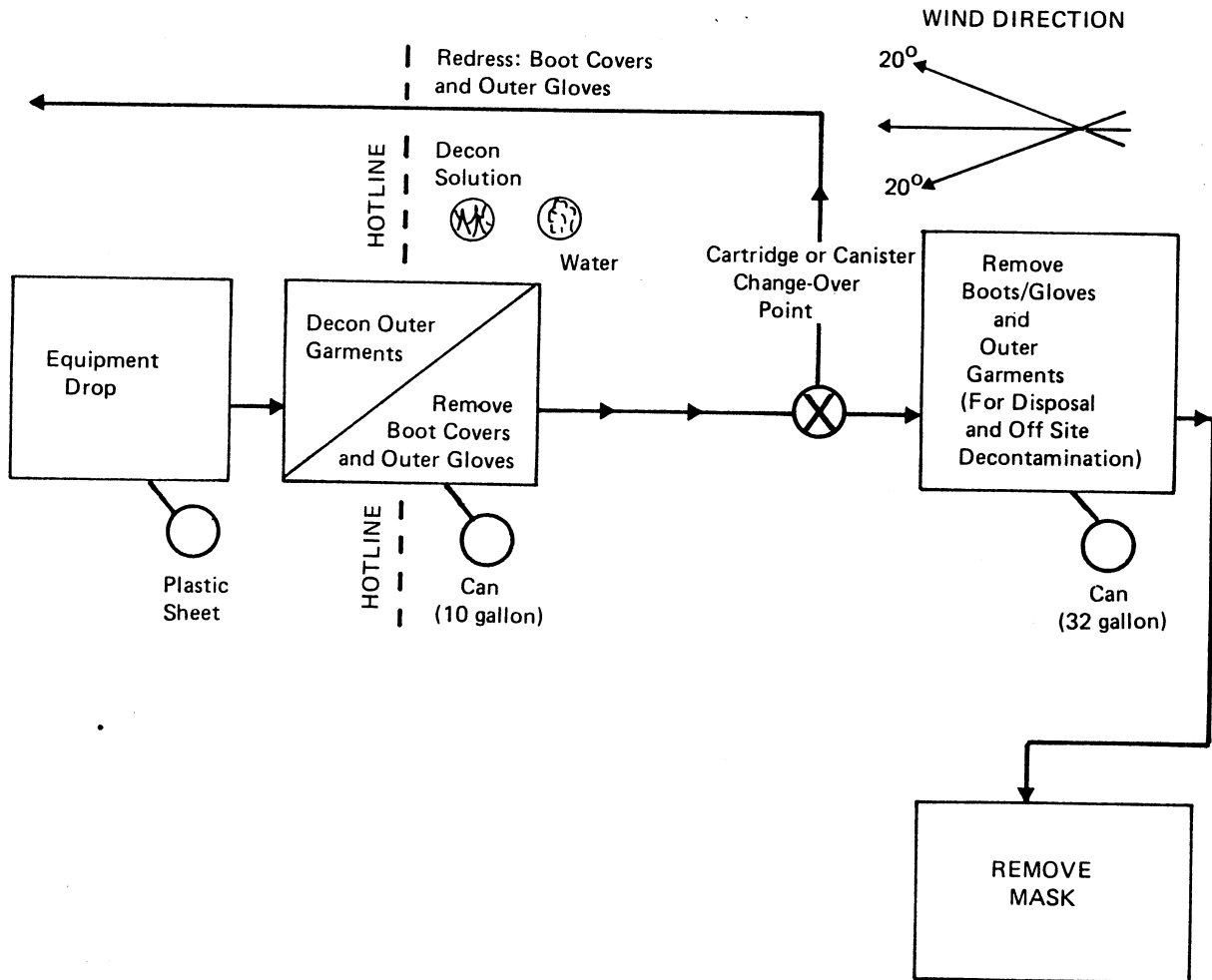

EQUIPMENT NEEDED TO PERFORM MAXIMUM DECONTAMINATION MEASURES FOR LEVELS A, B, AND C

| | | | |
|-------------------|---|--------------------|---|
| Station 1: | a. Various Size b. Plastic Liners c. Plastic Drop Cloths | Station 10: | a. Containers (20-30 Gallons) b. Plastic Liners c. Bench or Stools d. Boot Jack |
| Station 2: | a. Containers (20-30 Gallons) b. Decon Solution or Detergent Water c. 2-3 Long-Handled, Soft-Bristled Scrub Brushes | Station 11: | a. Rack b. Drop Cloths c. Bench or Stools |
| Station 3: | a. Containers (20-30 Gallons) OR High-Pressure Spray Unit b. Water c. 2-3 Long-Handled, Soft-Bristled Scrub Brushes | Station 12: | a. Table |
| Station 4: | a. Containers (20-30 Gallons) b. Plastic Liners | Station 13: | a. Basin or Bucket b. Decon Solution c. Small Table |
| Station 5: | a. Containers (20-30 Gallons) b. Plastic, Liners c. Bench or Stools | Station 14: | a. Water b. Basin or Bucket c. Small Table |
| Station 6: | a. Containers (20-30 Gallons) b. Plastic Liners | Station 15: | a. Containers (20-30 Gallons) b. Plastic Liners |
| Station 7: | a. Containers (20-30 Gallons) b. Decon Solution or Detergent Water c. 2-3 Long-Handled, Soft-Bristled Scrub Brushes | Station 16: | a. Containers (20-30 Gallons) b. Plastic Liners |
| Station 8: | a. Containers (20-30 Gallons) OR High-pressure Spray Unit b. Water c. 2-3 Long-Handled, Soft-Bristled Scrub Brushes | Station 17: | a. Containers (20-30 Gallons) b. Plastic Liners |
| Station 9: | a. Air Tanks or Face Masks and Cartridge Depending on Level b. Tape c. Boot Covers d. Gloves | Station 18: | a. Water b. Soap c. Small Table d. Basin or Bucket e. Field Showers f. Towels |
| | | Station 19: | a. Dressing Trailer is Needed in Inclement Weather b. Tables c. Chairs d. Lockers e. Cloths |

**EQUIPMENT NEEDED TO PERFORM MINIMUM DECONTAMINATION MEASURES FOR LEVELS
A, B, AND C**

- | | | | |
|-------------------|--|-------------------|--|
| Station 1: | a. Various Size Containers b. Plastic Liners c. Plastic Drop Cloths | Station 4: | Air Tanks or Masks and Cartridges Depending Upon Level b. Tape c. Boot Covers d. Gloves |
| Station 2: | a. Containers (20-30 Gallons) b. Decon Solution c. Rinse Water d. 2-3 Long-Handled, Soft- Bristled Scrub Brushes | Station 5: | a. Containers (20-30 Gallons) b. Plastic Liners c. Bench or Stools |
| Station 3: | a. Containers (20-30 Gallons) b. Plastic Liners c. Bench or Stools | Station 6: | a. Plastic Sheets b. Basin or Bucket c. Soap and Towels d. Bench or Stools |
| | | Station 7: | a. Water b. Soap c. Tables d. Wash Basin or Bucket |

FSOP 7: MAXIMUM MEASURES FOR LEVEL A DECONTAMINATION

| | | |
|--------------------|---|--|
| Station 1: | Segregated Equipment Drop | 1. Deposit equipment used on site (tools, sampling devices and containers, monitoring instruments, radios, clipboards, etc.) on plastic drop cloths or in different containers with plastic liners. During hot weather operations, a cool down station may be set up within this area. |
| Station 2: | Boot Cover and Glove Wash | 2. Scrub outer boot covers and gloves with decon solution or detergent/water. |
| Station 3: | Boot Cover and Glove Rinse | 3. Rinse off decon solution from station 2 using copious amounts of water. |
| Station 4: | Tape Removal | 4. Remove tape around boots and gloves and deposit in container with plastic liner. |
| Station 5: | Boot Cover Removal | 5. Remove boot covers and deposit in container with plastic liner. |
| Station 6: | Outer Glove Removal | 6. Remove outer gloves and deposit in container with plastic liner. |
| Station 7: | Suit and Boot Wash | 7. Wash encapsulating suit and boots using scrub brush and decon solution or detergent/water. Repeat as many times as necessary. |
| Station 8: | Suit and Boot | 8. Rinse off decon solution using water, Repeat as many times as necessary. |
| Station 9: | Tank Change | 9. If an air tank change is desired, this is the last step in the decontamination procedure, Air tank is exchanged, new outer gloves and boot covers donned, and Joints taped. Worker returns to duty. |
| Station 10: | Safety Boot Removal | 10. Remove safety boots and deposit in container with plastic liner. |
| Station 11: | Fully Encapsulating Suit and Hard Hat Removal | 11. Fully encapsulated suit is removed with assistance of a helper and laid out on a drop cloth or hung up. Hard hat is removed. Hot weather rest station maybe set up within this area for personnel returning to site. |
| Station 12: | SCBA Backpack Removal | 12. While still wearing facepiece, remove backpack and place on table. Disconnect hose from regulator valve and proceed to next station. |
| Station 13: | Inner Glove Wash | 13. Wash with decon solution that will not ham the skin, Repeat as often as necessary. |
| Station 14: | Inner Glove Rinse | 14. Rinse with water, Repeat as many times as necessary. |
| Station 15: | Face Piece Removal | 15. Remove face piece. Deposit in container with plastic liner. Avoid touching face with fingers. |
| Station 16: | Inner Glove Removal | 16. Remove inner gloves and deposit in container with liner. |
| Station 17: | Inner Clothing Removal | 17. Remove clothing and place in lined container. Do not wear inner clothing off-site since there is a possibility that small amounts of contaminants might have been transferred in removing the fully-encapsulating suit. |
| Station 18: | Field Wash | 18. Shower if highly toxic, skin-corrosive or skin-absorbable materials are known or suspected to be present. Wash hands and face if shower is not available. |
| Station 19: | Redress | 19. Put on clean clothes. |

FSOP 7: MINIMUM MEASURES FOR LEVEL A DECONTAMINATION

| | | |
|-------------------|---|---|
| Station 1: | Equipment Drop | 1. Deposit equipment used on-site (tools, sampling devices and containers, monitoring instruments, radios, clipboards, etc.) on plastic drop cloths. Segregation at the drop reduces the probability of cross contamination. During hot weather operations, cool down stations maybe set up within this area. |
| Station 2: | Outer Garment, Boots, and Gloves Wash and Rinse | 2. Scrub outer boots, outer gloves and fully- encapsulating suit with decon solution or detergent and water, Rinse off using copious amounts of water. |
| Station 3: | Outer Boot and Glove Removal | 3. Remove outer boots and gloves, Deposit in container with plastic liner. |
| Station 4: | Tank Change | 4. If worker leaves Exclusion Zone to change air tank, this is the last step in the decontamination procedure. Worker's air tank is exchanged, new outer gloves and boot covers' donned, joints taped, and worker returns to duty. |
| Station 5: | Boot, Gloves and Outer Garment Removal | 5. Boots, fully-encapsulating suit, inner gloves and removed and deposited in separate containers lined with plastic. |
| Station 6: | SCBA Removal | 6. SCBA backpack and facepiece is removed (avoid touching face with fingers), SCBA deposited on plastic sheets. |
| Station 7: | Field Wash | 7. Hands and face are thoroughly washed, Shower as soon as possible. |

FSOP 7: MAXIMUM MEASURES FOR LEVEL B DECONTAMINATION

| | | |
|--------------------|-----------------------------------|---|
| Station 1: | Segregated Equipment Drop | 1. Deposit equipment used on site (tools, sampling devices and containers, monitoring instruments, radios, clipboards, etc ,) on plastic drop cloths or in different containers with plastic liners. Segregation at the drop reduces the probability of cross-contamination, During hot weather operations, cool down stations may be set up within this area. |
| Station 2: | Boot Cover and Glove Wash | 2. Scrub outer boot covers and gloves with decon solution or detergent and water. |
| Station 3: | Boot Cover and Glove Rinse | 3. Rinse off decon solution from station 2 using copious amounts of water. |
| Station 4: | Tape Removal | 4. Remove tape around boots and gloves and deposit in container with plastic liner. |
| Station 5: | Boot Cover Removal | 5. Remove boot covers and deposit in container with plastic liner. |
| Station 6: | Outer Glove Removal | 6. Remove outer gloves and deposit in container with plastic liner. |
| Station 7: | Suit and Safety Boot Wash | 7. Wash chemical-resistant splash suit, SCBA, gloves and safety boots. Scrub with long-handle scrub brush and decon solution, Wrap SCBA regulator (if belt mounted type) with plastic to keep out water. Wash backpack assembly with sponges or cloths. |
| Station 8: | Suit, SCBA, Boot, and Glove Rinse | 8. Rinse off decon solution using copious amounts of water. |
| Station 9: | Tank Change | 9. If worker leaves exclusion zone to change air tank, this is the last step in the decontamination procedure. Worker's air tank is exchanged, new outer gloves and boot covers donned, and joints taped. Worker returns to duty. |
| Station 10: | Safety Boot Removal | 10. Remove safety boots and deposit in container with plastic liner. |
| Station 11: | SCBA Backpack Removal | 11. While still wearing facepiece, remove back-pack and place on table. Disconnect hose from regulator valve. |
| Station 12: | Splash Suit Removal | 12. With assistance of helper, remove splash suit..Deposit in container with plastic liner. |
| Station 13: | Inner Glove Wash | 13. Wash inner gloves with decon solution. |
| Station 14: | Inner Glove Rinse | 14. Rinse inner gloves with water. |
| Station 15: | Face Piece Removal | 15. Remove face piece. Deposit in container with plastic liner. Avoid touching face with fingers. |
| Station 16: | Inner Glove Removal | 16. Remove inner gloves and deposit in container with liner. |
| Station 17: | Inner Clothing Removal | 17. Remove inner clothing. Place in container with liner. Do not wear inner clothing off-site since there is a possibility that small amounts of contaminants might have been transferred in removing the fully-encapsulating suit. |
| Station 18: | Field Wash | 18. Shower if highly toxic, skin-corrosive or skin- absorbable materials are known or suspected to be present. Wash hands and face if shower is not available. |
| Station 19: | Redress | 19. Put on clean clothes. |

FSOP 7: MINIMUM MEASURES FOR LEVEL B DECONTAMINATION

| | | |
|-------------------|---|---|
| Station 1: | Equipment Drop | 1. Deposit equipment used on-site (tools, sampling devices and containers, monitoring instruments, radios, clipboards, etc.) on plastic drop cloths. Segregation at the drop reduces the probability of cross contamination. During hot weather operations, cool down station may be set up within this area. |
| Station 2: | Outer Garment, Boots, and Gloves Wash and Rinse | 2. Scrub outer boots, outer gloves and chemical-resistant splash suit with decon solution or detergent water. Rinse off using copious amounts of water. |
| Station 3: | Outer Boot and Glove Removal | 3. Remove outer boots and gloves. Deposit in container with plastic liner. |
| Station 4: | Tank Change | 4. If worker leaves exclusive zone to change air tank, this is the last step in the decontamination procedure. Worker's air tank is exchanged, new outer gloves and boot covers donned, Joints taped, and worker returns to duty. |
| Station 5: | Boot, Gloves and Outer Garment Removal | 5. Boots, chemical-resistant splash suit, inner gloves removed and deposited in separate containers lined with plastic. |
| Station 6: | SCBA Removal | 6. SCBA backpack and facepiece is removed. Avoid touching face with finger, SCBA deposited on plastic sheets. |
| Station 7: | Field Wash | 7. Hands and face are thoroughly washed. Shower as soon as possible. |

FSOP 7: MAXIMUM MEASURES FOR LEVEL C DECONTAMINATION

| | | |
|--------------------|--------------------------------|--|
| Station 1: | Segrated Equipment Drop | 1. Deposit equipment used on site (tools, sampling devices and containers, monitoring instruments, radios, clipboards, etc.) on plastic drop cloths or in different containers with plastic liners. Segregation at the drop reduces the probability of cross contamination. During hot weather operations, a cool down station may be set up within this area. |
| Station 2: | Boot Cover and Glove Wash | 2. Scrub outer boot covers and gloves with decon solution or detergent and water. |
| Station 3: | Boot Cover and Glove Rinse | 3. Rinse off decon solution from station 2 using copious amounts of water. |
| Station 4: | Tape Removal | 4. Remove tape around boots and gloves and deposit in container with plastic liner. |
| Station 5: | Boot Cover Removal | 5. Remove boot covers and deposit in containers with plastic liner. |
| Station 6: | Outer Glove Removal | 6. Remove outer gloves and deposit in container with plastic liner. |
| Station 7: | Suit and Boot Wash | 7. Wash splash suit, gloves, and safety boots. Scrub with long-handle scrub brush and decon solution. |
| Station 8: | Suit and Boot, and Glove Rinse | 8. Rinse off decon solution using water. Repeat as many times as necessary. |
| Station 9: | Canister or Mask Change | 9. If worker leaves exclusion zone to change canister (or mask), this is the last step in the decontamination procedure. Worker's canister is exchanged, new outer gloves and boot covers donned, and joints taped worker returns to duty. |
| Station 10: | Safety Boot Removal | 10. Remove safety boots and deposit in container with plastic liner. |
| Station 11: | Splash Suit Removal | 11. With assistance of helper, remove splash suit. Deposit in container with plastic liner. |
| Station 12: | Inner Glove Rinse | 12. Wash inner gloves with decon solution. |
| Station 13: | Inner Glove Wash | 13. Rinse inner gloves with water. |
| Station 14: | Face Piece Removal | 14. Remote face piece. Deposit in container with plastic liner. Avoid touching face with fingers. |
| Station 15: | Inner Glove Removal | 15. Remove inner gloves and deposit in lined container. |
| Station 16: | Inner Clothing Removal | 16. Remove clothing soaked with perspiration and place in lined container. Do not wear inner clothing off-site since there is a possibility that small amounts of contaminants might have been transferred in removing the fully-encapsulating suit. |
| Station 17: | Field Wash | 17. Shower if highly toxic, skin-corrosive or skin-absorbable materials are known or suspected to be present. Wash hands and face if shower is not available. |
| Station 18: | Redress | 18. Put on clean clothes. |

FSOP 7: MINIMUM MEASURES FOR LEVEL C DECONTAMINATION

| | | |
|-------------------|---|---|
| Station 1: | Equipment Drop | 1. Deposit equipment used on-site (tools, sampling devices and containers, monitoring instruments, radios, clipboards, etc.) on plastic drop cloths. Segregation at the drop reduces the probability of cross contamination. During hot weather operations, a cool down station may be set up within this area. |
| Station 2: | Outer Garment, Boots, and Gloves Wash and Rinse | 2. Scrub outer boots, outer gloves and splash suit with decon solution or detergent water. Rinse off using copious amounts of water. |
| Station 3: | Outer Boot and Glove Removal | 3. Remove outer boots and gloves. Deposit in container with plastic liner. |
| Station 4: | Canister or Mask Change | 4. If worker leaves exclusive zone to change canister (or mask), this is the last step in the decontamination procedure. Worker's canister is exchanged, new outer gloves and boot covers donned, Joints taped, and worker returns to duty. |
| Station 5: | Boot, Gloves and Outer Garment Removal | 5. Boots, chemical-resistant splash suit, inner gloves removed and deposited in separate containers lined with plastic. |
| Station 6: | Face Piece Removal | 6. Facepiece is removed. Avoid touching face with fingers, Facepiece deposited on plastic sheet. |
| Station 7: | Field Wash | 7. Hands and face are thoroughly washed. Shower as soon as possible. |

Appendix E. NIOSH, OSHA, and EPA Regional Offices and USCG District Offices

NIOSH Regional Offices

HHS Region I
Government Center
(JFK Federal Building)
Boston, MA 02203
Telephone: (617) 223-3848

HHS Region II
26 Federal Plaza, Room 3337
New York, NY 10278
Telephone: (212) 264-5747

HHS Region III
521-35 Market Street
P.O. Box 13716
Philadelphia, PA 19101

HHS Region IV
101 Marietta Tower, Suite 1007
Atlanta, GA 30323
Telephone: (404) 221-2396

HHS Region V
300 South Wacker Drive, 33rd Floor
Chicago, IL 60606
Telephone: (312) 886-3881

HHS Region VI
1200 Main Tower Building
Room 1835
Dallas, TX 75202
Telephone: (214) 767-3916

HHS Region VII
601 East 12th Street
Kansas City, MO 64106
Telephone: (816) 3743491

HHS Region VIII
1185 Federal Building
1961 Stout Street
Denver, CO 80294
Telephone: (303) 844-6163 x17

HHS Region IX
50 United Nations Plaza
San Francisco, CA 94102
Telephone: (415) 556-3782

HHS Region X
2901 Third Avenue, M.S.402
Seattle, WA 98121
Telephone: (206) 442-0530

OSHA Regional Offices

OSHA Region I
16-18 North Street
1 Dock Square Building, 4th Floor
Boston, MA 02109
Telephone: (617) 223-6710

OSHA Region II
One Astor Plaza, Room 3445
1515 Broadway
New York, NY 10036
Telephone: (212) 944-3432

OSHA Region III
Gateway Building, Suite 2100
3535 Market Street
Philadelphia, PA 19104
Telephone: (215) 596-1201

OSHA Region IV
1375 Peachtree Street, N.E.,
Suite 587
Atlanta, GA 30367
Telephone: (404) 881-3573

OSHA Region V
230 South Dearborn Street
32nd Floor, Room 3244
Chicago, IL 60604
Telephone (312) 353-2220

OSHA Region VI
525 Griffin Square, Room 602
Dallas, TX 75202
Telephone: (214) 767-4731

OSHA Region VII
911 Walnut Street, Room 406
Kansas City, MO 64106
Telephone: (816) 374-5861

OSHA Region VII
Federal Building, Room 1554
1961 Stout Street
Denver, CO 80294
Telephone: (303) 837-3061

OSHA Region IX
450 Golden Gate Avenue
Box 36017
San Francisco, CA 944102
Telephone: (415) 556-7260

OSHA Region X
Federal Office Building,
Room 6003
909 First Avenue
Seattle, WA 98174
Telephone: (206) 442-59930

EPA Regional Offices

EPA Region 1
JFK Federal Building
Boston, MA 02203
Telephone: (617) 223-7210

EPA Region II
26 Federal Plaza
Room 900
New York, NY 10218

EPA Region III
841 Chestnut, Street
Philadelphia, PA 199107
Telephone: (215) 597-9800

EPA Region IV
345 Cortland Street, N.E.
Atlanta, GA 303365
Telephone: (404) 881-4727

EPA Region V
230 S. Dearborne Street
Chicago, IL 60604
Telephone: (312) 353-2000

EPA Region VI
First International Building
1201 Elm Street
Dallas, TX 75270
Telephone: (214) 767-2600

EPA Region VII
One Denver Place
999 18th Street, Suite 1300
Denver, CO 80202-2413
Telephone: (303) 293-1603

EPA Region IX
215 Fremont Street
San Francisco, CA 94105
Telephone: (415) 974-8153

EPA Region X
1200 6th Avenue
Seattle, WA 988101
Telephone: (206) 442-5810

USCG District Offices

Commander (mep)
 First Coast Guard District
 150 Causeway Street
 Boston, MA 02114
 Telephone: (617) 223-6915

Commander (meps)
 Second Coast Guard District
 1430 Olive Street
 St. Louis, MO 63103
 Telephone: (314) 425-4655

Commander (mer)
 Third Coast Guard District
 Governors Island
 New York, NY 10004
 Telephone: (212) 668-7152

Commander (mep)
 Fifth Coast Guard District
 Federal Building
 431 Crawford Street
 Portsmouth, VA 23705
 Telephone: (804) 398-6383

Commander (mep)
 Seventh Coast Guard District
 Federal Building
 51 S.W. 1st Avenue
 Miami, FL 33130
 Telephone: (305) 350-5276

Commander (mep)
 Eighth Coast Guard District
 Hale Boggs Federal Building
 500 Camp Street
 New Orleans, LA 70130
 Telephone: (504) 589-6296

Commander (mep)
 Ninth Coast Guard District
 1240 East 9th Street
 Cleveland, Ohio 44199
 Telephone: (216) 522-3918

Commander (mep)
 Eleventh Coast Guard District
 Union Band Building
 400 Oceangate
 Long Beach, CA 90822
 Telephone: (213) 590-2301

Commander (mepps)
 Twelfth Coast Guard District
 Building 51
 Government Island
 Alameda, CA 94501
 Telephone: (415) 437-3465

Commander (mep)
 Thirteenth Coast Guard District
 Federal Building
 915 Second Avenue
 Seattle, WA 98174
 Telephone: (206) 442-5850

Commander (mep)
 Fourteenth Coast Guard District
 Prince Kalaniana'ole Federal Building
 300 Ala Moana Boulevard, 9th

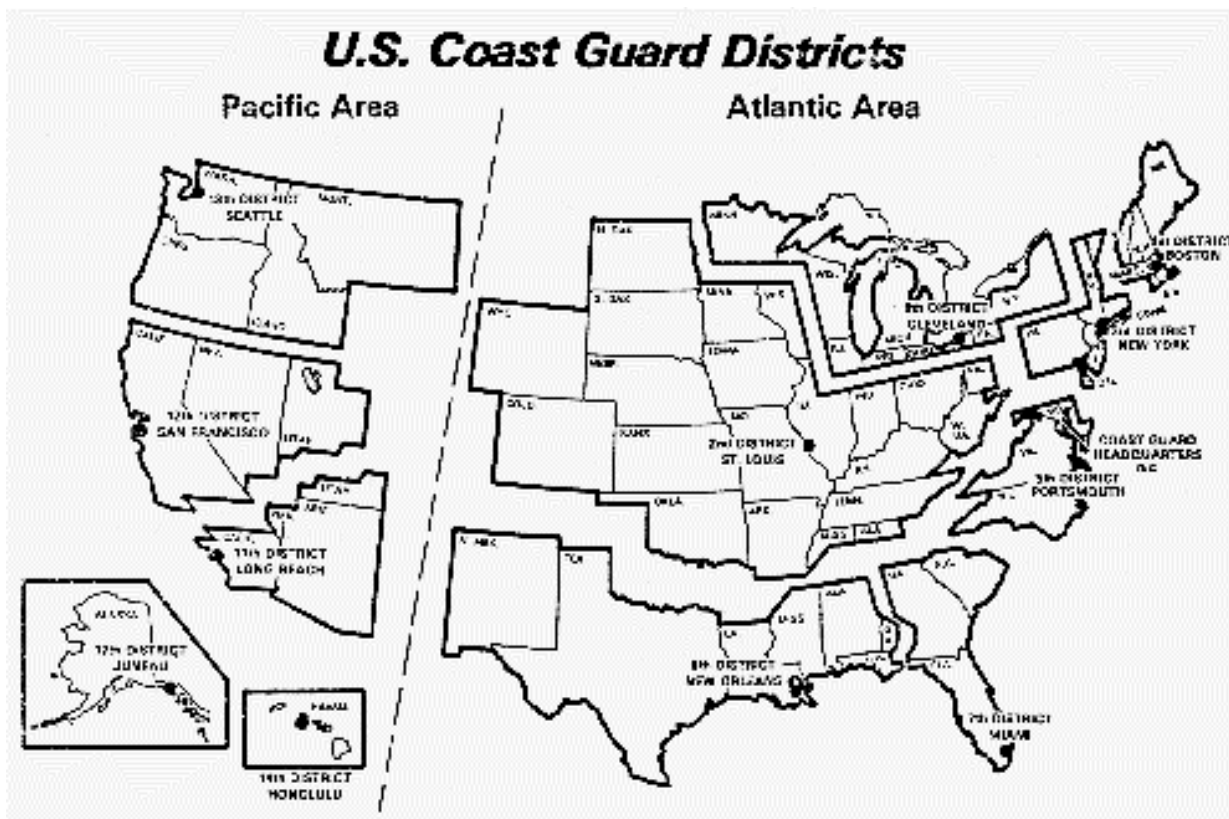

NIOSH, OSHA, AND EPA REGIONS

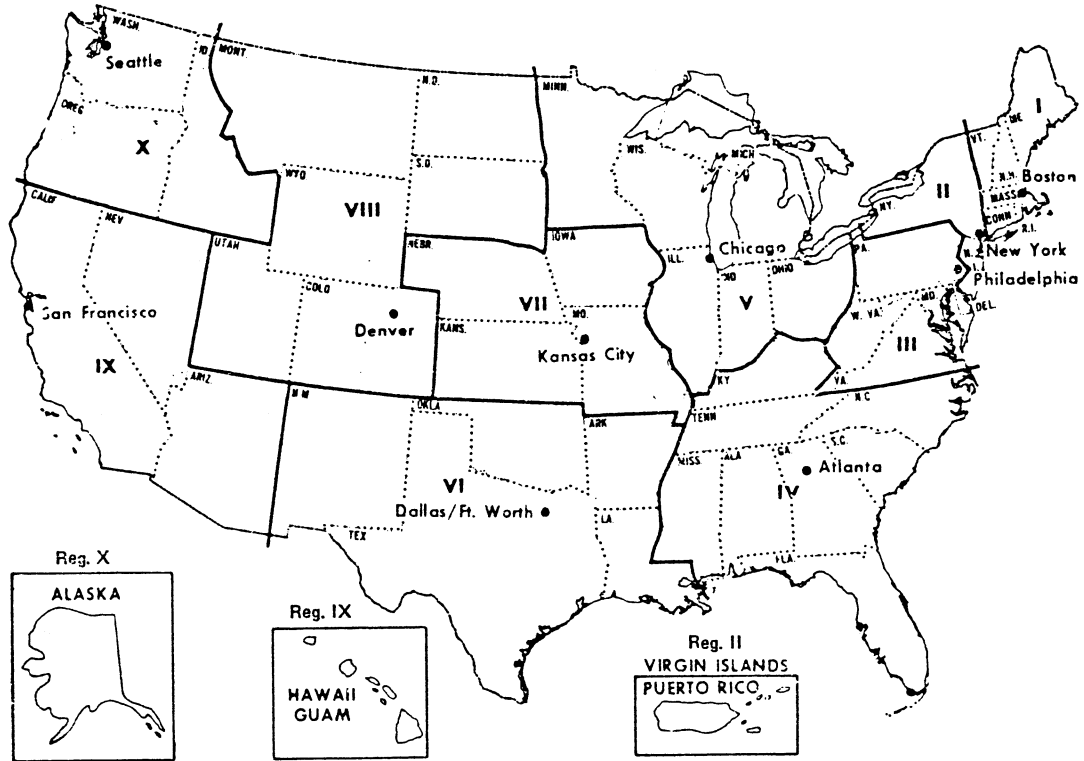

*U.S. GOVERNMENT PRINTING OFFICE: 1996 750-176/40007