

# Health and safety in construction

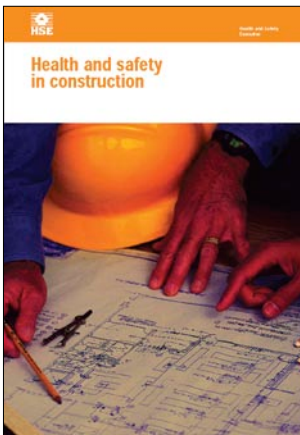

**This is a free-to-download, web-friendly version of HSG150 (Third edition, published 2006). This version has been adapted for online use from HSE's current printed version.**

You can buy the book at [www.hsebooks.co.uk](http://www.hsebooks.co.uk) and most good bookshops.

**ISBN 978 0 7176 6182 2**

This is the third edition of *Health and safety in construction*. It has been updated and expanded in the light of new legislation, in particular the Work at Height Regulations 2005. It also features new information on recent advances and examples of good practice in the construction industry.

This book is aimed at the small contractor but also applies to everyone involved in construction. It provides help and assistance on how to work safely on most tasks you will encounter. It will also help to identify the main causes of accidents and ill health and explains how to eliminate hazards and control risks. The guidance is simple but comprehensive. The solutions are straightforward and easy to adopt.

The first two editions sold over 250 000 copies, making it one of the most popular guides to construction health and safety.

© *Crown copyright 2006*

First published 1996

ISBN 978 0 7176 6182 2

You may reuse this information (not including logos) free of charge in any format or medium, under the terms of the Open Government Licence. To view the licence visit [www.nationalarchives.gov.uk/doc/open-government-licence/](http://www.nationalarchives.gov.uk/doc/open-government-licence/), write to the Information Policy Team, The National Archives, Kew, London TW9 4DU, or email [psi@nationalarchives.gsi.gov.uk](mailto:psi@nationalarchives.gsi.gov.uk).

Some images and illustrations may not be owned by the Crown so cannot be reproduced without permission of the copyright owner. Enquiries should be sent to [copyright@hse.gsi.gov.uk](mailto:copyright@hse.gsi.gov.uk).

This guidance is issued by the Health and Safety Executive. Following the guidance is not compulsory and you are free to take other action. But if you do follow the guidance you will normally be doing enough to comply with the law. Health and safety inspectors seek to secure compliance with the law and may refer to this guidance as illustrating good practice.

# Contents

## Foreword 4

## Introduction 5

### 1: Preparing for work 7

- Planning the work 8
- Organising the work 9
- Notifying the site to HSE 9

### 2: Setting up the site 11

- Site access 11
- Site boundaries 11
- Welfare facilities 11
- Good order, storage areas and waste materials 14
- Lighting 15
- Emergency procedures 16
- Fire 17
- First aid 19
- Reporting injuries, diseases and dangerous occurrences 20
- Site rules 20

### 3: Construction-phase health and safety 20

- Site management and supervision 21
- Working at height 22
- Site traffic and mobile plant 54
- Moving goods safely 62
- Groundwork 70
- Demolition, dismantling and structural alteration 78
- Occupational health risks 81
- Electricity 94
- Slips and trips 98
- Working in confined spaces 99
- Prevention of drowning 102
- Protective equipment 103
- Work affecting the public 106
- Monitoring and reviewing 110

### 4: Health and safety management and the law 110

## Appendices 129

- 1: Inspection recording form with timing and frequency chart 129
- 2: Construction health and safety checklist 131

## References and further information 137

## Foreword

**Every year many construction site workers are killed or injured as a result of their work; others suffer ill health, such as musculoskeletal disorders, dermatitis or asbestosis. The hazards are not, however, restricted to those working on sites. Children and other members of the public are also killed or injured because construction activities have not been adequately controlled.**

The construction industry's performance has shown a steady long-term improvement, which I welcome. However there is no room for complacency.

We can so easily believe that accidents will always happen to other people and will never touch us. But unless we all recognise our own vulnerability – and just how vulnerable others can be – then, as a result of the decisions we make, construction workers and their families will continue to witness the unnecessary injuries, pain and suffering that so tragically afflict the industry.

In addition, accidents and ill health have a financial cost. The business case for improving performance is absolutely clear.

This publication is aimed at the small contractor but is also applicable to all those involved in construction. It provides help and assistance on how to work safely on most tasks you are likely to encounter. It also helps you identify the main causes of accidents and ill health, and explains how to eliminate hazards and control risks. The guidance is simple but comprehensive. The solutions provided are straightforward and easy to adopt.

Please read this publication and turn the advice into action. Doing so may well prevent you and other people from becoming victims of accidents or suffering ill health.



*Stephen Williams.*

**Stephen Williams**

HM Chief Inspector of Construction

Chair of the Health and Safety Commission's Construction Industry Advisory Committee

# Introduction

## What is this book about?

1 This book explains the essential tasks for achieving healthy and safe construction sites. It will help you to identify hazards and control risks and it explains how to plan, organise, control, monitor and review health and safety throughout the life of a project.

## Who should read this book?

2 The book is aimed at everybody involved in construction work, including clients, designers, contractors and individual workers. It will appeal most to:

- directors and partners running construction businesses;
- site managers and supervisors running sites;
- managers and supervisors who work on sites run by other companies; and
- those doing the construction work, including employees and the self-employed.

3 Clients, designers and others who specify construction work may also find the book useful. Clients can use the book to identify the skills and competences contractors need to work safely and without risks to health. Designers, specifiers and planning supervisors can use it to identify the most common risks that contractors have to manage on site. They can then take account of how to design out or reduce these risks when they prepare their designs, specifications and plans.

## What sort of construction work does this book cover?

4 It provides guidance for people who work on all kinds of construction sites, including:

- general building and construction work;
- refurbishment work;
- maintenance and repair work;
- engineering construction work; and
- civil engineering work.

## How is the book structured?

5 The book is divided into four sections:

### ***Section 1: Preparing for work***

6 This section covers planning and organising the job to ensure health and safety is taken into account from the very beginning.

### ***Section 2: Setting up the site***

7 This section deals with setting up the site before work starts to ensure the fundamental health and safety issues have been addressed.

### Section 3: Construction-phase health and safety

8 This section summarises the main requirements for controlling and supervising site activities to ensure safe systems of work are followed. It helps the reader to identify health and safety hazards found on many sites and advises on how to control the risks that can arise. It then outlines the requirements for monitoring and reviewing to ensure site health and safety is maintained through to completion of the job.

9 The book cannot address every hazard, but it does focus on those matters that are the common causes of death, injury and ill health. It provides guidance on how to eliminate the hazards, or where this cannot be done, reduce the risk. Advice is given on protecting those who are directly employed to do the work, others working on the site, visitors to the site and members of the public who could be affected.

#### Accidents

10 The most frequent causes of accidental death and injury are:

- **Falls:** People fall because access to and from the workplace is not adequate, or the workplace itself is not safe. The importance of providing good access to a safe working position (eg a platform with toe boards and guard rails) cannot be over-emphasised.
- **Mobile plant:** Construction plant can be heavy. It often operates on ground which is muddy and uneven, and where driver visibility is poor. People walking on site are injured or killed by moving vehicles, especially reversing ones. Others, particularly drivers and operators, are killed or injured by overturning vehicles and plant.
- **Falling material and collapses:** People are struck by material falling from loads being lifted and material that rolls or is kicked off work platforms; others are struck or buried by falling materials when excavations, buildings or structures collapse. Structural collapses can range from walls, which fall because their foundations are undermined by nearby excavations, to buildings, which collapse during alteration works because the structure was weakened and/or overloaded. Structures can also collapse unexpectedly during demolition if action is not taken to prevent instability. Scaffolds collapse because ties are either forgotten or removed too early during striking, or the scaffold is overloaded. Structures under construction may also collapse, eg steel frames that have not been adequately braced, or formwork that is prematurely loaded.
- **Electrical accidents:** People suffer electric shock and burns when they use unsafe equipment and when they contact overhead power lines and buried cables.
- **Trips:** Trips are the most common cause of reported injuries on construction sites, with over 1000 major injuries each year. Most of these can be easily avoided by effective management of access routes such as corridors, stairwells and footpaths.

### *Ill health*

11 The construction industry has a poor health record. Construction workers are likely to suffer ill health as a result of their work in the industry after exposure to both harsh working conditions and hazardous substances. Ill health can result from:

- **Asbestos:** Exposure to asbestos can cause serious respiratory diseases such as asbestosis and cancer.
- **Manual handling:** Lifting heavy and awkward loads causes back and other injuries. Some injuries can result from a single lift, but more commonly, long-term injury develops as a result of repeated minor injury due to repetitive lifting.
- **Noise and vibration:** High levels of noise can cause hearing loss and repeated use of vibrating tools can cause hand-arm vibration syndrome (damage to nerves and blood vessels – most commonly in the hands and fingers).
- **Chemicals:** Exposure to materials such as cement and solvents can cause skin problems such as dermatitis.

### *Section 4: Health and safety management and the law*

12 The law requires health and safety issues to be managed and controlled. This section sets out the most important parts of the law that apply to construction. It explains what needs to be done to ensure health and safety is dealt with effectively.

### *References and further information*

13 Sources of further information about site health and safety, which you may find useful, are listed at the back of this book. Regularly updated advice and guidance on many of the issues covered in this publication is also available on the Health and Safety Executive's (HSE's) website at [www.hse.gov.uk/construction](http://www.hse.gov.uk/construction).

### *Why has this book been revised?*

14 This guidance replaces the 2001 revision of *Health and safety in construction* (Second edition, ISBN 0 7176 2106 5) and takes into account new legislation, in particular the Work at Height Regulations 2005.<sup>1</sup> It builds on previous editions by incorporating recent advances and examples of good practice identified within the construction industry.

## 1: Preparing for work

15 The key to achieving healthy and safe working conditions is to ensure that health and safety issues are planned, organised, controlled, monitored and reviewed.

16 Everyone controlling site work has health and safety responsibilities. Checking that working conditions are healthy and safe before work begins and ensuring that the proposed work is not going to put others at risk requires planning and organisation.

17 This applies equally to a firm running and managing a small job, or to a subcontractor working at a large site controlled by someone else. Planning has to consider changes to the site as it develops – from welfare arrangements at the set up, through to snagging work and the dismantling of site huts and hoardings at the end of the contract. The basic requirements apply to all jobs.

18 The principal contractor, who is appointed under the Construction (Design and Management) Regulations 1994<sup>2</sup> (CDM), has more formal responsibilities for securing health and safety on site. These are set out in Section 4. The legal requirements of CDM do not apply to every job (see Section 4 Figure 54). Whether or not CDM applies, the principles of successful health and safety management are the same.

### **Planning the work**

19 Gathering as much health and safety information about the project and the proposed site before work begins is important. Information available at tendering should be used so that allowance is made for the time and resources required to deal with particular problems. Sources of information include:

- the client;
- the design team;
- contract documents;
- the main contractors on the site;
- specialist contractors and consultants;
- trade and contractor organisations;
- equipment and material suppliers; and
- HSE guidance and British or European Standards.

20 Find out about the history of the site and its surroundings. See if there are any unusual features which might affect the work, or how the work will affect others. Pay particular attention to:

- asbestos or other contaminants;
- overhead power lines and underground services;
- unusual ground conditions;
- public rights of way across the site;
- nearby schools, footpaths, roads or railways; and
- other activities going on at the site.

21 Where CDM applies, much of this information should be found in the pre-construction-stage health and safety plan. Make sure its contents have been taken into account before tenders are submitted. Where CDM does not apply, gathering information is still important.

22 When estimating costs and preparing the programme, consider any particular health and safety hazards associated with the work. Make sure suitable allowances have been made in the price. The job will run more smoothly, efficiently and profitably if hazards have been predicted, planned for and controlled from the outset. Having to stop or reschedule work to deal with emergencies wastes time and money.

23 When materials are bought, or equipment is hired, the supplier has a duty to provide certain health and safety information. Make sure this is obtained and read. It may be necessary to:

- consider using a specialist who is familiar with the necessary precautions;
- carry out an assessment of the health risks arising from substances or equipment; and
- act on your findings, eg by eliminating harmful substances where possible, or by using a less hazardous method of work or providing training on the safe use of the material or equipment.



24 When programmes are prepared, consider whether there are any operations that will affect the health or safety of others working at the site. For example:

- think about access to the workplace – which trades will need to go where and when? Arrange the programme to make sure everyone who needs to use a scaffold or other means of access has time to do so. Plan to make sure the access will be safe and suitable for their use;
- timber treatment or site radiography usually has to be done when no one else is on site. The site may have to be left vacant for a few days. Where a specialist contractor is used, check the requirements with them and programme the work well in advance.

25 Discuss proposed working methods with subcontractors before letting contracts. Find out how they are going to work, what equipment and facilities they are expecting to be provided and the equipment they will bring to the site. Identify any health or safety risks that their operations may create for others working at the site and agree control measures. Obtaining health and safety risk assessments and method statements will help (see paragraphs 580-597).

26 Decide what plant will be required and check that it will be suitable.

27 Plan material deliveries and consider storage needs.

28 Plan your emergency and rescue procedures. Decide what equipment will be required and who is trained to operate it.

### **Organising the work**

29 Decide who will supervise the work – check that they are adequately trained and experienced.

30 When taking on workers, ask about the training they have received and ask to see certificates of training achievement. Get them to demonstrate their knowledge or to show examples of safe working practice before setting them to work.

31 Make sure that firms coming onto site provide adequate supervision for their workers. Agree what training they will have received or will be provided at the site.

32 See that work methods and safety precautions agreed before work is started are put into practice. Make sure everyone understands how work is to be done and is aware of relevant method statements before work starts.

33 Find out if any of the work will be further subcontracted. Make sure that people working for subcontractors also get the information they require and provide training, supervision etc as needed.

### **Notifying the site to HSE**

34 HSE should be notified in writing before construction starts (see Figure 1) if the work is expected to either:

- last longer than 30 days; or
- involve more than 500 person days of construction work.

35 The notification should be sent to the HSE office nearest to the proposed site. You can obtain this information from HSE's Infoline Tel: 0845 345 0055.

36 A form (Form 10 rev) can be used for notification. Forms are available from HSE offices. It is not essential that this form is used for notification, but the information required on Form 10 must be provided in writing to HSE. A copy of the notification details should be displayed at a place on site where it can be easily read.

37 Where CDM applies to the work, notification of the project will be the responsibility of the planning supervisor (see paragraphs 630-631). The planning supervisor should update the information as it becomes available (eg when the principal contractor is appointed). Where CDM does not apply, it will be the responsibility of the contractors to notify the site to HSE. A flow diagram illustrating when CDM applies to a project is given in Section 4 Figure 54.

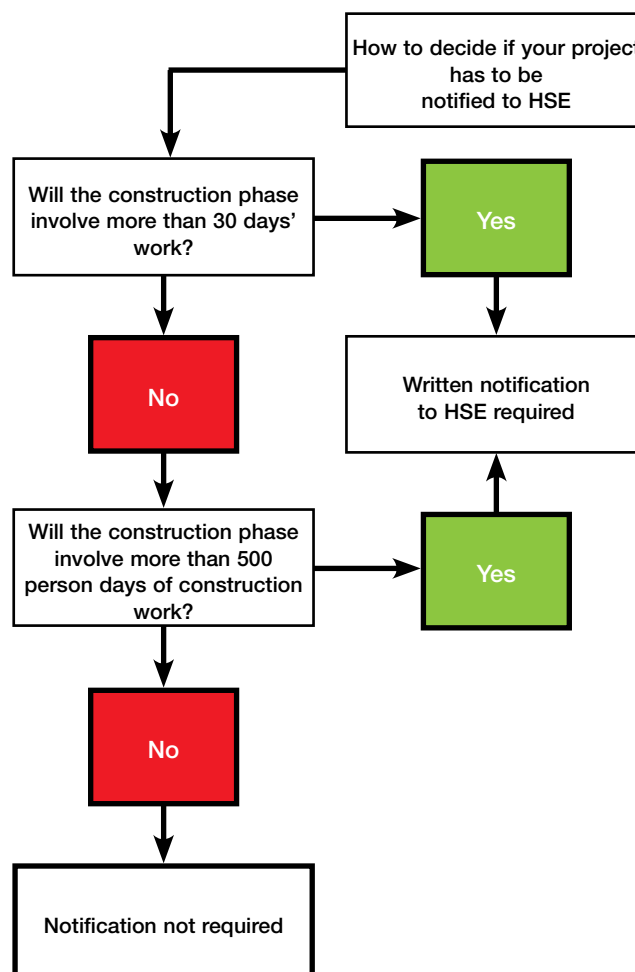

**Figure 1** F10 notification requirements

## 2: Setting up the site

### Site access

38 There should be safe access onto and around the site for people and vehicles. Plan how vehicles will be kept clear of pedestrians, especially at site entrances where it may be necessary to provide doors or gates to achieve this segregation. Doors that open onto traffic routes may need viewing panels or windows.

39 Your plan should include how vehicles can be kept clear of pedestrians at vehicle loading/unloading areas, parking and manoeuvring places and areas where drivers' vision may be obstructed. For further information, see *Safe use of vehicles on construction sites*.<sup>3</sup>

### Site boundaries

40 Construction work should be fenced off and suitably signed. This will protect people (especially children) from site dangers and the site from vandalism and theft. For some jobs the workplace will have to be shared. Perhaps the work will be done in an operating factory or office. Agree who has to control each area. Agree what fences, barriers, means of separation or permits to work are required to keep both construction workers away from hazards created by others and other people away from hazards created by the construction work; site rules might be needed (see paragraphs 100-101). Make sure there is a system to ensure necessary precautions are kept in place during working hours and that night-time and weekend protection is put in place as required before the site closes. For further information, see *Protecting the public: Your next move*.<sup>4</sup>

### Welfare facilities

41 Everyone who works on any site must have access to adequate toilet and washing facilities, a place for preparing and consuming refreshments and somewhere for storing and drying clothing and personal protective equipment.

42 Principal contractors and others who have control over construction sites are responsible for providing or making available site welfare facilities. Employers are also responsible for ensuring that welfare facilities are adequate for their employees.

43 The welfare facilities should be sufficient for everybody who is working on the site. If facilities such as toilets and canteens provided by someone else are to be used, check that they are suitable and properly maintained. They should be kept clean, warm and properly ventilated and lit.

44 Welfare facilities should be easily available to people working on the site. Toilets need to be easily accessible from where the work is being done. Washing facilities should be as close as possible to the toilets. Washing facilities also need to be close to canteens and rest rooms so that people can wash before eating.

45 In almost all cases, these facilities will be provided on site. Where the work is of short duration, arrangements still need to be made for welfare facilities.

46 If mobile gangs are employed to work at a number of locations over a few days (eg road repair and cable-laying gangs), facilities can be provided at a central location. This is on condition that they are available to workers within reasonable

walking distance or within a reasonable time, taking into account the available transport. Workers should not be left to make their own arrangements on an 'as and when required' basis.

### **Sanitary conveniences**

47 The numbers of toilets required will depend on the number of people working on the site.

48 Wherever possible toilets should be flushed by water and connected to a mains drainage system. If this is not possible, toilets with a built-in water supply and drainage tank may be provided. If neither option is possible, chemical toilets may be provided. Figure 2 shows a self-contained water-flushing toilet block with built-in tank.

49 Men and women may use the same toilet, provided it is in a separate room with a door that can be locked from the inside.

50 A washbasin with water, soap and towels or dryers should be located close to the toilets.

### **Washing facilities**

51 On all sites, provide basins large enough to allow people to wash their faces, hands and forearms (see Figure 3). All basins should have a supply of clean hot and cold, or warm, running water. If mains water is not available, water supplied from a tank may be used.



**Figure 2** A self-contained water-flushing toilet block with built-in tank



**Figure 3** Washbasin large enough for people to wash their forearms

52 Soap and towels (either roller-type cloth or paper) or dryers should also be provided. It is good practice to provide skincare products.

53 Where the work is particularly dirty or workers are exposed to toxic or corrosive substances (eg during demolition or work in contaminated ground), showers should be provided.

54 Men and women can share basins used for washing their faces, hands and arms.

55 A shower may be used by both men and women provided that it is in a separate room with a lock on the inside of the door.

#### **Rest facilities**

56 Facilities should be available for taking breaks and meal breaks (see Figure 4). The facilities should provide shelter from the wind and rain and be heated as necessary.

57 The rest facilities should have:

- tables and chairs;
- a kettle or urn for boiling water;
- a means of heating food (eg a gas or electrical heating ring, or microwave oven).

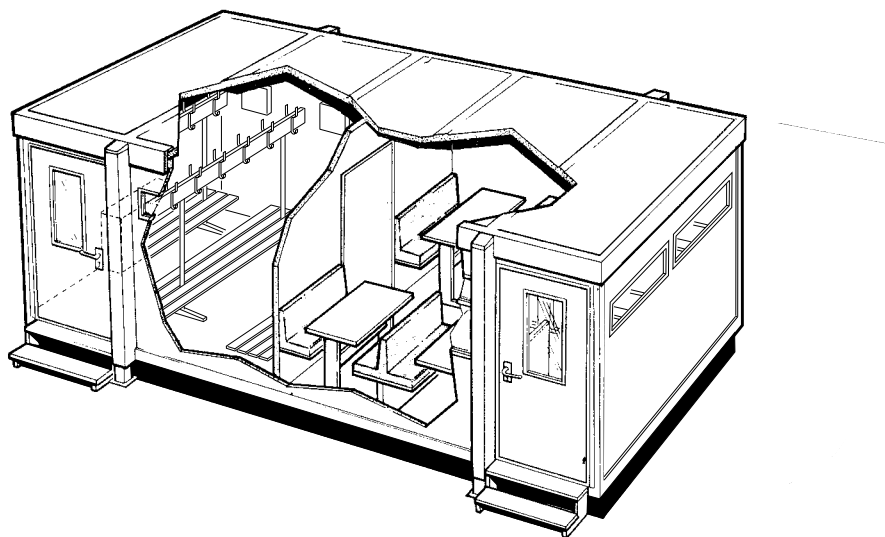

**Figure 4** A welfare unit with a rest area and drying room

58 It should be possible for non-smokers to use the facilities without suffering discomfort from tobacco smoke. This can be achieved by providing separate facilities for smokers and non-smokers, or by prohibiting smoking in the rest facilities.

59 For small sites, rest facilities can often be provided within the site office or site hut, especially where this is one of the common portable units.

60 Remember, open-flued gas heaters and gas cooking rings can produce carbon monoxide if there is inadequate ventilation. When poorly maintained, they also give rise to leaks of methane which can ignite or explode without warning. Gas appliances should not be used in site huts, containers or other enclosed areas unless there are vents or louvres that give a permanent supply of fresh air that cannot be closed off (a window that can be opened is not adequate as it is likely to be closed in cold weather). LPG cylinders must be stored in the open air, if necessary locked cages may be used to secure them.

### **Storing and drying clothing and personal protective equipment**

61 Make sure there are proper arrangements for storing:

- clothing not worn on site (eg hats and coats);
- protective clothing needed for site work (eg Wellington boots, overalls, gloves etc);
- personally issued equipment (eg ear defenders, goggles, harnesses etc).

62 Separate lockers might be needed, although on smaller sites the site office may be a suitable storage area, provided it is kept secure. Where there is a risk of protective site clothing contaminating everyday clothing, store items separately.

63 Where necessary for propriety, men and women should be able to change separately.

64 A drying area should be provided to dry wet site clothing. This area should be separated from the eating area (see Figure 4).

65 If electrical heaters are used, ensure that they are either fitted with a high-temperature cut-out device or are properly ventilated. Many fires have been caused by placing clothing on electrical heaters to dry, making the appliance overheat.

### **Drinking water**

66 Make sure there is a supply of drinking water. It is best if a tap direct from the mains is available, otherwise bottles or tanks of water may be used for storage. If water is stored, it should be protected from possible contamination and changed often enough to prevent it from becoming stale or contaminated.

67 The tap should be clearly marked if it is possible to confuse the drinking water supply with other water supplies or other liquids such as:

- those not fit for consumption (eg water from storage tanks used for wheel washers); or
- certain toxic materials (eg from taps to pipelines in factories).

68 Cups or other drinking vessels should be available at the water tap, unless the water is supplied as an upward jet that can be drunk from easily (eg a drinking fountain).

### **Good order, storage areas and waste materials**

69 Plan how the site will be kept tidy and how housekeeping will be actively managed:

- keep walkways and stairways free of tripping hazards such as trailing cables, building materials and waste. This is especially important for emergency routes. Make sure that all flammable waste materials (such as packaging and timber offcuts) are cleared away regularly to reduce fire risks;
- keep inside floor areas clean and dry;
- outdoor footpaths should be level and firm and should not be used for storing materials.

70 Designate storage areas for plant, materials, waste, flammable substances (eg foam plastics, flammable liquids and gases such as propane) and hazardous substances (eg pesticides and timber treatment chemicals). Flammable materials will usually need to be stored away from other materials and protected from accidental ignition. Do not store materials where they obstruct access routes or where they could interfere with emergency escape, eg do not store flammable materials under staircases or near to doors or fire exits (see Figure 5).



**Figure 5** A designated timber storage area

71 If materials are stored at height (eg on top of a container or on a scaffold gantry), make sure necessary guard rails are in place if people could fall when stacking or collecting materials or equipment.

72 Keep all storage areas tidy, whether in the main compound or on the site itself. Try to plan deliveries to keep the amount of materials on site to a minimum.

73 Decide how the waste stream will be managed to ensure it is timely and effective. You might want to consider whether you will require the contractors to be responsible for collecting their own waste or whether you will provide someone to do this for the site. Don't forget that waste materials also need storing safely before their removal from the site and make sure that you allow sufficient space for waste skips and bins. If you are collecting waste in skips you will need to decide where the skips can be positioned and how often they will need to be collected (see Figure 6). Consider waste generated inside and whether you need to provide wheeled bins to enable it to be brought out of the building safely.

### **Lighting**

74 Every part of the site that is in use should, as far as possible, be arranged so that natural light is available for people to see to do their work and move about the site safely. Where natural light is inadequate or not available, artificial lighting should be provided.

75 Where work will continue outside daylight hours or the building or structure is enclosed, artificial lighting will be required. Make sure that any artificial lighting does not change the apparent colour or visibility of any safety signs or other safety-related items such as fire extinguishers.

76 With both daylight and artificial light, shadows can obscure hazards both at the workplace (eg making it difficult to see the blade of a cutting disc or a drill bit) and on the site generally (eg at stairwells). If necessary, provide extra lighting to illuminate shadow areas.

77 Where failure of the primary artificial lighting would be a risk to the health or safety of anyone (eg someone working on a tower scaffold in a basement may fall while trying to descend in the dark), provide emergency lighting. Where it is not possible to have lighting that comes on automatically when the primary lighting fails, torches or other similar lights may provide suitable lighting.

78 In addition, emergency routes (the corridors, passageways etc that people must follow in an emergency to escape from danger) should be kept well lit while there are workers on the site. Where daylight provides adequate lighting, no further action is required. Where emergency routes need artificial light, provide emergency lighting that comes on if the primary lighting fails (eg battery or emergency generator-powered lighting). See also *Emergency procedures* (paragraphs 79-82). Emergency lighting does not have to provide the same level of lighting as under normal circumstances; merely enough to enable escape.



**Figure 6** A designated waste collection area

### **Emergency procedures**

79 At most sites, the most obvious emergency is fire. The general principles for dealing with fire risks are considered in greater detail in paragraphs 83-93. These general principles can be applied to planning for other emergencies, such as flooding in excavations, tunnels, work near the sea or rivers, waterworks etc, or a risk from asphyxiation or toxic gases. Plan emergency procedures before work begins and put general precautions in place from the start of work.

80 Some emergencies may require evacuation of the site or part of the site, while others might involve the rescue of an injured person. For example, it may be necessary to plan how someone injured in a fall within a confined space or within a restricted plant room can be attended to by first aiders and the emergency services before being taken to a place of safety.



### Planning for an emergency

81 When planning emergency procedures, routes and exits, take into account:

- the type of work being done on site (eg extra precautions may be required to maintain routes down stairs during demolition);
- the characteristics and size of the site and the number and location of workplaces on the site. A large site with people working at many locations will probably need bells or sirens at a number of places to raise the alarm. On small sites with only two or three people working, an air horn may be adequate;
- the plant and equipment being used (eg consider tower crane drivers, people working on suspended access equipment or where the exit may be obstructed by equipment);
- the number of people likely to be present on the site at any one time. On sites where many people work, escape routes need to be wide enough to allow everyone to get through doorways or down stairs easily without them becoming overcrowded; and
- the physical and chemical properties of substances or materials on or likely to be on the site (eg work at petrochemical installations or at sites where flammable paints or glues are in use may require an increased standard of ventilation).

82 Take precautions to ensure:

- the likelihood of emergencies arising is as low as possible;
- everyone on site can be alerted in an emergency;
- everyone working on site (including contractors who may only be at the site for a few hours) knows what signal will be given if there is an emergency and knows what to do;
- someone who has been trained in what to do is on site while work is in progress and will take responsibility for co-ordinating procedures;
- emergency routes are available, kept clear, signed and adequately lit. When the site is not adequately lit by daylight for all periods when people are at work, provide lighting that will come on automatically in an emergency;
- there are arrangements for calling the emergency services. It is good practice to let the Fire Brigade know about any work in tunnels, confined spaces or above 18 m (above this height they may require specialist access equipment) and anywhere else where specialised rescue equipment may be needed;
- there is adequate access to the site for the emergency services and that access does not become blocked by plant or material building up;
- arrangements for treating and recovering injured people are available;
- if an emergency does arise, someone is posted at the site entrance, or in another prominent position, so that they can direct the emergency services.

### Fire

83 Many solids, liquids and gases can catch fire and burn. It only takes a source of ignition, which may be a small flame or an electrical spark, together with air. Any outbreak of fire threatens the health and safety of those on site and will be costly in damage and delay. It can also be a hazard to people in surrounding properties. Fire can be a particular hazard in refurbishment work when there is a lot of dry timber and at the later stages of building jobs where flammable materials such as adhesives, insulating materials and soft furnishings are present.

84 Many fires can be avoided by careful planning and control of work activities. Good housekeeping and site tidiness are important not only to prevent fire, but also to ensure that emergency routes do not become obstructed. Making site rules can help.

### **Precautions to prevent fires**

85 The following precautions should be taken to prevent fires:

- use less-easily ignited and fewer flammable materials, eg use water-based or low-solvent adhesives and paint;
- keep the quantity of flammables at the workplace to a minimum;
- always keep and carry flammable liquids in suitable closed containers;
- if work involving the use of flammable materials is being carried out, stop people smoking and don't allow other work activities involving potential ignition sources to take place nearby. For example, if floor coverings are being laid using solvent-based adhesives, don't allow soldering of pipes at the same time;
- ensure that pipes, barrels, tanks etc which may have contained flammable gases or liquids are purged or otherwise made safe before using hot cutting equipment, such as a cutting torch or angle grinder. A pipe or container may appear to be empty, but can contain enough material on its sides, or within rust or other sediments, to produce a flammable or explosive atmosphere within it when heated or disturbed. Specialist advice may be required;
- to minimise the risk of gas leaks and fires involving gas-fired plant:
  - close valves on gas cylinders when not in use;
  - regularly check hoses for wear and leaks;
  - prevent oil or grease coming into contact with oxygen cylinder valves;
  - do not leave bitumen boilers unattended when alight;
- store flammable solids, liquids and gases safely. Separate them from each other and from oxygen cylinders or oxidising materials. Keep them in ventilated secure stores or an outdoor storage area. Do not store them in or under occupied work areas or where they could obstruct or endanger escape routes;
- have an extinguisher to hand when doing hot work such as welding or using a disc cutter that produces sparks;
- check the site at lunch time and at the end of the day to see that all plant and equipment that could cause a fire is turned off. Stop hot working an hour before people go home, as this will allow more time for smouldering fires to be identified; and
- provide closed metal containers to collect rubbish and remove them from the site regularly. Collect highly flammable waste such as solvent-soaked rags separately in closed fire-resisting containers.

### **Precautions in case of fire**

86 If a fire should break out, people must be able to escape from it. To achieve this consider the points in paragraphs 87-93.

#### **Means of giving warning**

87 Set up a system to alert people on site; this could be a temporary or permanent mains operated fire alarm (which should be tested regularly, eg weekly), a klaxon, an air horn or a whistle, depending on the size and complexity of the site. Any warning needs to be distinctive, audible above other noise and recognisable by everyone.

#### **Means of escape**

88 Plan escape routes and ensure they remain available and unobstructed. For work areas above or below ground, provide well separated alternative ways to ground level where possible. Protect routes by installing the permanent fire separation and fire doors as soon as possible. It is important that escape routes give access to a safe place where people can assemble and be accounted for. In a large chemical plant this may be a safety refuge, while on a small site the pavement outside may be adequate. Signs will be needed if people are not familiar with the escape routes (see Figure 7). Make sure that adequate lighting is provided for enclosed escape routes – emergency lighting may be required (see paragraph 78);

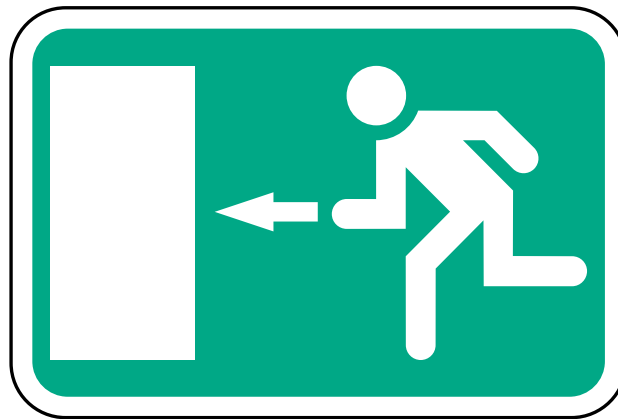

**Figure 7** An example of an emergency exit sign

### ***Means of fighting fire***

89 As well as providing fire extinguishers for hot work, fire extinguishers should be located at identified fire points around the site. The extinguishers should be appropriate to the nature of the potential fire:

- wood, paper and cloth – water extinguisher;
- flammable liquids – dry powder or foam extinguisher;
- electrical – carbon dioxide (CO<sub>2</sub>) extinguisher.

90 Nominated people should be trained in how to use extinguishers.

91 If the building being worked in is occupied (eg an office, hotel or hospital), make sure the work does not interfere with the escape route from the building, or any fire separation, alarms, dry risers, or sprinkler systems. Check this with the building occupier or the Fire Brigade.

92 Fire doors should never be locked, left open or removed. Keep existing wet and dry risers ready for use and install any new ones as soon as possible.

93 For more information, read *Fire safety in construction work*.<sup>5</sup>

### **First aid**

94 First aid can save lives, reduce pain and help an injured person make a quicker recovery. The Health and Safety (First Aid) Regulations 1981<sup>6</sup> require you to provide adequate and appropriate equipment, facilities and personnel to enable first aid to be given to your employees if they are injured or become ill at work. The minimum provision for all sites is:

- a first aid box with enough equipment to cope with the number of workers on site;
- an appointed person to take charge of first-aid arrangements;
- information telling workers the name of the appointed person or first aider and where to find them. A notice in the site hut is a good way of doing this.

95 An appointed person is someone you choose to take charge when someone is injured or falls ill and who will telephone for an ambulance if one is required. An appointed person should not attempt to give first aid for which they have not been trained.

96 A first aider is someone who has undergone a training course in administering first aid at work and holds a current first aid at work certificate. A first aider can undertake the duties of an appointed person. The number of qualified first aiders needed depends on the risk of injury and ill health on site. As a guide:

<b>Numbers employed at any location</b>	<b>Number of first aid personnel</b>
Fewer than five	At least one appointed person
5 to 50	At least one first aider
More than 50	One additional first aider for every 50 employed

97 The first-aid arrangements should cover shift working, night and weekend working where this is carried out. This may mean appointing or training several people to ensure adequate cover.

### **Reporting injuries, diseases and dangerous occurrences**

98 Employers have a duty under the law (Reporting of Injuries, Diseases and Dangerous Occurrences Regulations 1995)<sup>7</sup> to report to HSE certain types of accidents that happen to their employees. Whoever is in control of the site also has a legal obligation to report certain accidents which involve a self-employed worker or member of the public and certain dangerous occurrences.

99 Generally, you have to report deaths, serious injuries and dangerous occurrences immediately and less serious injuries within ten days. Certain occupational ill-health issues and diseases also have to be reported. Further details of when you must report an accident, disease or dangerous occurrence are given in paragraphs 668-673.

### **Site rules**

100 Clients may insist on certain safety precautions, especially where their business continues at the premises while construction work is in progress. It may assist everyone if site rules are applied. Site rules might cover, for example, the use of personal protective equipment, traffic management systems, pedestrian routes, site tidiness, fire prevention, emergency procedures or permit-to-work systems.

101 Make it clear where your site rules apply and where the client premises rules apply. Make sure everybody knows and follows the rules relevant to them.

## **3: Construction-phase health and safety**

102 In construction work, many of the hazards (a hazard is something with the potential to cause harm) are obvious. Most of them can be found on almost every site. The causes of accidents are well known and often repeated. Too often hazards are just seen as an inevitable part of the job, so no action is taken to control the risks they create. Consequently, the rate of accidents and ill health remains high. Action is needed to change this.

103 This section identifies the most common causes of death, injury and ill health and sets out straightforward precautions. Applying this advice will make work safer and, in most cases, improve efficiency.

104 Some activities (eg roof work and steel erection) are considered in detail, but in general most operations will present a number of hazards, which are dealt with on a number of pages. For example:

- Painting may include:
  - a risk of falls;
  - paints and solvents, which may be health hazards.
- Fitting out in an office being refurbished may involve:
  - a risk of falls;
  - a risk of tripping over trailing cables or waste materials;
  - electrical risks from portable equipment; and
  - a risk of exposure to asbestos.

105 The information in this section will help those carrying out risk assessments (see paragraphs 580-591) by explaining how to identify hazards and select control measures. In finalising an appropriate safe system of work for any construction job, it will be necessary to consider the particular nature of the site and the detail of the operations to be carried out. Where the Construction (Design and Management) Regulations 1994<sup>2</sup> (CDM) apply, the health and safety plan (see paragraphs 612-615) may provide additional useful information.

## Site management and supervision

106 Effective management of work activities and competent site supervision are essential in maintaining healthy and safe conditions. It should be made clear to supervisors exactly what it is they are expected to do and how they are expected to do it. The greater the risk, the greater the degree of control and supervision required.

107 Ensure the level of site supervision provided is adequate. Site managers and supervisors should be trained to help them discharge their health and safety responsibilities. On larger sites, site managers may require the support of assistant site managers. On smaller sites, if the supervisor or manager is sometimes not present, they (or a deputy) should be contactable by phone and a responsible person should be left in charge of the site.

108 Before work starts:

- consider if there are any hazards you can avoid altogether (eg the need to paint at height can be eliminated if materials are brought to site ready-finished);
- decide which risks need to be controlled;
- consider the best ways of controlling them; and then
- having decided what needs to be done, make sure it happens.

109 Check that:

- everyone is properly trained and competent;
- they have the equipment they need; and
- agreed work methods are put into practice.

110 When people (either employees, other contractors or visitors) first come to site, it is important that they receive information about the site hazards and the steps that have been taken to control the risks. Make sure that the person running the site can be easily identified; if there is a site office, sign it clearly. A site plan showing the office location, placed at the site entrance together with an instruction that all visitors report to the site office, can be helpful. The principal contractor has a duty to take reasonable steps to ensure that only authorised people are allowed where construction work is being done.

111 People who are going to work on the site for the first time should be briefed about risks, welfare facilities and site rules. One way of doing this is by making sure the site supervisor speaks to them before they start work. They might also be given an information sheet or relevant information might be displayed on a notice board prominently placed near the site entrance. Remember, many people are killed and seriously injured during the first few days that they work at a site.

112 Ask people working at the site for their views and ideas about health and safety and how working conditions or systems can be improved. This can be done during formal meetings or on an informal basis either face to face or using a suggestion box.

113 Health and safety checks can be incorporated into normal progress and quality checks carried out by supervisors and managers. Specific additional checks on higher-risk work may also be needed.

114 Included at the back of the book is a health and safety checklist, which may be photocopied. This list covers issues which need to be addressed on almost every site. It can be used by those planning work to help them decide if they have addressed the most significant risks before work starts and also as a tool for site supervisors and others who may need to monitor site conditions. The checklist is a guide; there may be additional matters at some sites which are vital to address.

115 Carrying out routine checks from time to time reminds everyone that health and safety matters!

## Working at height

116 Work at height means work in any place, including a place at or below ground level, where if measures required by the Work at Height Regulations 2005<sup>1</sup> are not taken, a person could fall a distance liable to cause personal injury. Work at height also includes obtaining access to or egress from a place of work at height.

### The hierarchy of control measures

117 Falls are the largest cause of accidental death in the construction industry. They account for 50% of all fatalities. **There is no distinction between low and high falls.** This means that for any work at height, precautions are required to prevent or minimise the risk of injury from a fall.

118 To prevent or minimise risk when planning for work at height, consider the work to be done and take a sensible risk-based approach to identify suitable precautions. There is a hierarchy of control measures for determining how to work at height safely. **The hierarchy has to be followed systematically and only when one level is not reasonably practicable may the next level be considered.** Where it is reasonably practicable to prevent a fall, precautions should be taken to do so. It is not acceptable to select work equipment from lower down the hierarchy (eg personal fall arrest systems such as harnesses and lanyards) in the first instance.

119 Those in control of the work must:

- **avoid** work at height where they can (see Figure 8);
- use work equipment to **prevent** falls where work at height cannot be avoided;
- where the risk of a fall cannot be eliminated, use work equipment to **minimise the distance and consequences** of a fall should one occur;
- always consider measures that protect all those at risk, ie **collective protection measures** (scaffolds, nets, soft landing systems) before measures that only protect the individual, ie **personal protection measures** (a harness);
- ensure work is carried out only when weather conditions do not jeopardise the health and safety of the workers.

120 The hierarchy of control measures with practical examples:

- **Avoid** working at height unless it is essential (eg erect guard rails on steelwork at ground level and then crane the steel and the guard rails into position; provide cast in mesh across riser ducts at the position of services; fix nets using extending poles).
- **Prevent** falls by using an existing safe place of work that does not require the use or addition of work equipment to prevent a fall (eg a flat roof with permanent edge protection).
- **Prevent** falls by using work equipment that protects all those at risk (eg access equipment fitted with guard rails, such as independent scaffolds, tower scaffolds, mobile elevating work platforms (MEWPs) and mast climbing work platforms (MCWPs)).
- **Prevent** falls by using work equipment that protects the individual (eg a harness with a short lanyard which makes it impossible for a person to get to a fall position (this is called work restraint) or use a podium).
- **Mitigate** falls by using work equipment to minimise the distance and consequences of a fall and protect all those at risk (eg nets or soft landing systems positioned close under the work surface).
- **Mitigate** falls by using work equipment to minimise the distance and consequences of a fall and protect the individual (eg a personal fall arrest system with the anchorage point sited above the head, or a rope access system).
- **Mitigate** falls by using work equipment that minimises the consequences of a fall (eg nets rigged at a lower level, or inflatable injury protection).
- **Mitigate** falls through training, instruction or other means (eg ensure ladders are inspected regularly and are used by competent people, demarcate areas to provide a warning, provide adequate lighting, apply sensible housekeeping measures, provide suitable footwear etc).

## Selecting the right means of access and work equipment

121 When planning for working at height that is unavoidable, the first choice will be to use any existing safe place of work that allows safe access and provides a safe working place. Where it is not reasonably practicable to work safely from the existing place of work, an alternative means of access will be needed. This will involve the use of work equipment.

122 Traditionally, much work has been done from scaffolding. However, other means of access (such as MEWPs and tower scaffolds) will ensure collective fall prevention because they are equipped with guard rails. Personal measures, such as podium steps, can also be used to prevent falls. If fall prevention is not reasonably practicable, other work equipment can be used to minimise the distance and consequences of a fall using, for example, personal suspension equipment such as rope access techniques and boatswain's chairs.

123 Ladders are at the bottom of the hierarchy because they do not prevent or mitigate a fall. However, if they are used by competent people and are regularly inspected and well maintained, then their use may be justified providing it is not reasonably practicable to use other work equipment which will prevent or mitigate a fall.

124 It is also essential to consider what risks there may be in erecting and removing the access equipment as well as using it.

125 When deciding upon the safest means of access and selecting the most suitable work equipment, you will need to consider:

- the distance and consequences of a potential fall;
- how long the work will last and how often it will be undertaken;
- how many people will be working at height and require protection;
- the space available on the site. Each type of platform requires a minimum amount of space, eg MEWPs need outriggers – check you can fit them in;
- the type of work to be carried out, eg some work may require heavy loads on the platform;
- what risks there will be during the erection and removal of the platform;
- can the equipment be stabilised, eg check that the scaffold can be tied;
- what will happen in adverse weather conditions;
- whether part of the structure can be provided early in the work so that there is a permanent working platform; and
- what emergency and rescue procedures are required.



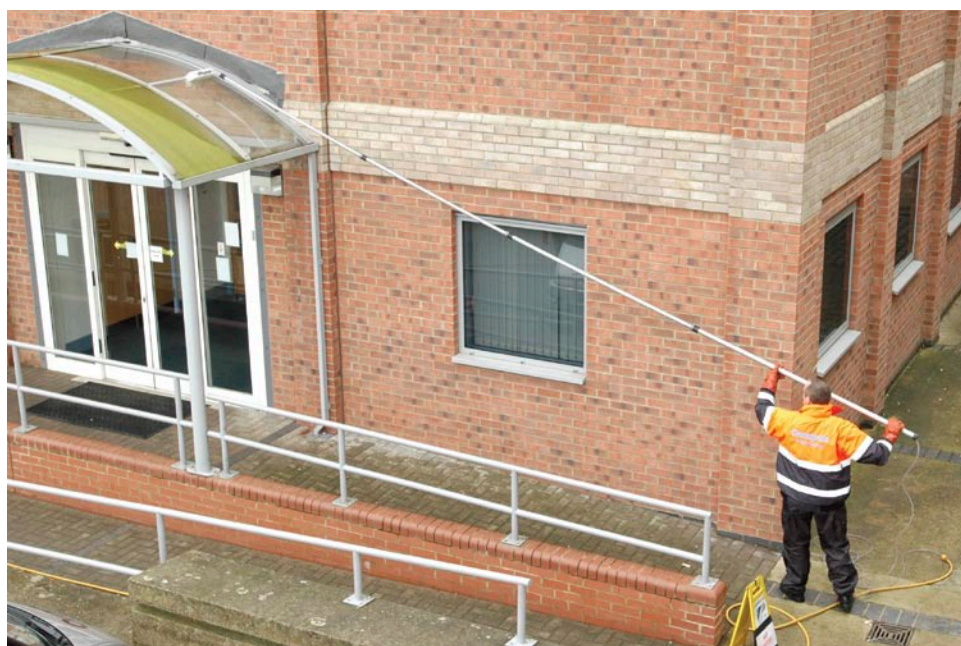

**Figure 8** Using a long pole to avoid working at height

126 Most accidents involving falls could have been prevented if the right equipment had been provided and properly used.

127 Summary of steps to take before working at height:

- Ask yourself whether any of the work can be carried out without working at height.
- Start at the top of the hierarchy to decide what equipment will provide the safest method of getting to the work area and carrying out the job.
- Check that the selected equipment is suitable for the conditions on site.
- Make sure that the equipment needed is delivered to site in good time and that the site has been prepared for it.
- Check that the equipment is in good condition and make sure that whoever puts the equipment together is competent and knows what they are doing.
- Make sure those who use the equipment are supervised so that they use it properly.
- The more specialised the equipment (eg boatswain's chairs and rope access equipment), the greater the degree of training and supervision required to ensure safety.
- Check any equipment provided by another company is safe before using it.
- Find out who to tell if any defects need to be remedied or modifications need to be made and keep them informed.
- Ensure you have procedures for rescuing an injured person and handling an emergency situation.

128 When selecting a means of access, remember:

- only when it is not practicable to provide a work platform that prevents falls (eg scaffolds, MEWPs) should measures which mitigate falls (eg nets, soft landing systems, personal fall arrest systems etc) be used;
- whenever harnesses are used, a method must be available to enable people to be rescued should they fall and be left suspended in their harness. Rescue kits and training can often be provided by the harness suppliers;

- it may be necessary to put measures in place to protect those installing guard rails or other fall protection measures;
- ladders should always be prevented from slipping and be positioned to ensure stability. They should be primarily used for access and only be used as workplaces for light work of short duration, and then only if it is safe to do so (see paragraphs 218-219). It is generally safer to use a tower scaffold or MEWP even for short-term work;
- heavy work activity (such as drilling or carrying heavy or awkward loads) should never be carried out from a ladder. When climbing a ladder with a load, a safe handhold must always be maintained. When working from a ladder, a secure handhold must be available;
- when selecting a safe system of work at height, all the risks have to be considered before one method is selected. For example, if nets are selected (see paragraphs 194-198), is there adequate clearance under the nets to prevent injury to those who may fall into them? If harnesses are used (see paragraphs 204-217), is there sufficient clearance from the ground to allow the shock-absorbing lanyard or inertia reel to deploy? Make sure that no one will be put at risk while the equipment is being removed;
- before any work at height, check that there is adequate clearance for equipment, eg overhead power lines can be a risk when erecting scaffolds or using MEWPs, or there can be a risk of crushing against nearby structures when mobile access platforms are manoeuvred.

### **Safe working platforms**

129 A working platform is virtually any surface from which work is carried out, such as a roof, scaffold, MEWP, tower scaffold, trestle etc. It becomes a safe working platform when you can't fall off it or through it or when measures have been taken to mitigate a fall from it.

130 Make sure the working platform is:

- capable of supporting the weight of the workers using it and any materials and equipment they are likely to use or store on it;
- stable and will not overturn. For example, scaffolds usually need to be tied to a supporting structure and MEWPs should not be operated on sloping or uneven ground;
- wide enough to allow people to pass back and forth safely and use any equipment or material necessary for their work at that place;
- kept clear of loose materials and constructed to prevent materials from falling. As well as toe boards or similar protection at the edge of the platform, the platform itself should be constructed to prevent any object that may be used on the platform from falling through gaps or holes, causing injury to people working below. For scaffolds, a close-boarded platform would suffice, although for work over public areas, a double-boarded platform sandwiching a polythene sheet, fans or protected walkways may also be needed. If MEWPs or cradles are used and they have meshed platform floors, the mesh should be fine enough to prevent materials, especially nails and bolts, from slipping through;
- free of openings and traps through which people's feet could pass, causing them to trip, fall or be injured in any other way; and
- kept free of tripping and slipping hazards. Keep platforms clean and tidy and do not allow materials or waste to build up on them.

## Inspections and reports

131 All working platforms must be inspected by a competent person:

- after installation or assembly in any position;
- after any event likely to have affected its stability, eg following strong winds or substantial alteration; and
- at regular intervals if the working platform is below 2 m or at intervals not exceeding seven days if the working platform is at 2 m or above.

132 The person in control must have the inspections carried out by a competent person. This is someone with the appropriate training (eg attendance at a scaffolding inspection course) and experience to enable them to identify any risks that are present and decide upon the measures required to control the risks.

133 Whoever controls the activities of others who use a scaffold also needs to ensure it is safe before they use it for the first time.

134 If the competent person is not satisfied that work can be carried out safely, they should advise the person the inspection was carried out for (eg a senior manager of the principal contractor) as soon as possible. Stop work if the inspection shows it is not safe to continue.

135 The result of an inspection should be recorded and kept until the next inspection is recorded.

136 However, if the working platform is 2 m or above in height and the inspection is carried out after installation or assembly or to comply with the seven-day inspection regime, the competent person must:

- complete the inspection report before the end of the working period;
- provide a copy of the report to the person the inspection was carried out for within 24 hours.

137 The person receiving the report must:

- keep it at the site where the inspection was carried out until construction work is completed;
- thereafter, keep it at an office for three months.

138 The report should contain the following information:

- name and address of the person the inspection was carried out for;
- location of the place of work or work equipment inspected;
- description of the place of work or work equipment inspected;
- date and time of the inspection;
- details of any matter identified that could give rise to a risk to the health or safety of any person;
- details of any action taken as a result of any matter identified in the point above;
- details of any further action considered necessary;
- name and position of the person making the report.

139 Appendix 1 contains an inspection timing and frequency chart and a suggested format that may be reproduced or copied for recording this information. The suggested form does not have to be used – any form containing the required information is acceptable. The reverse of the form summarises the requirements for timing and frequency of inspections.

### General access scaffolds

140 Suitable precautions must be taken to prevent falls. General access scaffolds provide a means of working at height while preventing falls and should be provided whenever practicable.

141 Scaffolds should be designed, erected, altered and dismantled only by competent people and the work should always be carried out under the direction of a competent supervisor. Scaffolders should always adopt methods of work to prevent falls during the erection of scaffolding. This can be achieved by using an advanced guard rail system. Where this is not practicable, harnesses should be worn to provide a means of fall arrest. For further information on erecting scaffolding, see the National Access and Scaffolding Confederation's guidance note *Preventing falls in scaffolding and falsework*.<sup>8</sup>

142 Scaffolds should never be erected or dismantled over people or busy pavements. If the work presents a danger to the public, you should apply for a road closure to eliminate the risk of a member of the public being injured. If this is not granted, erection and dismantling should be done inside a segregated area and during the times when there are fewer members of the public in the vicinity.

143 Ensure the scaffold is based on a firm, level foundation. The ground or foundation should be capable of supporting the weight of the scaffold and any loads likely to be placed on it. Watch out for voids such as basements or drains, or patches of soft ground, which could collapse when loaded. Provide extra support as necessary.

144 Ensure it is braced and tied into a permanent structure or otherwise stabilised. Rakers only provide stability when they are braced and footed adequately; single-tube rakers alone do not usually provide this and need to be braced to prevent buckling. Put ties in place as the scaffold is erected and only remove them in stages as it is struck. If a tie is removed to allow work to proceed, an equivalent tie should be provided nearby to maintain stability. Ties must be used within their safe working load limit. Proprietary system scaffolds should be erected and tied according to the manufacturers' instructions.

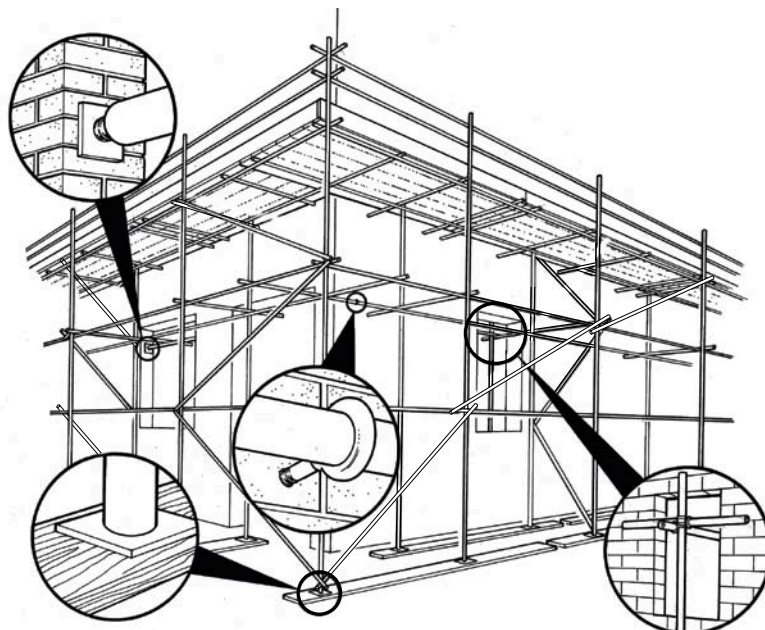

**Figure 9** An independent scaffold

145 Scaffolds must be capable of supporting loads likely to be placed on them. Scaffolds are not usually designed to support heavy loads on their working platforms. If you are intending to load out platforms, inform whoever is providing the scaffold – a special design is likely to be required. The duty rating of your scaffold should be appropriate to the work you are doing. Scaffolds should be assumed to be ‘general purpose’ (2 kN/m<sup>2</sup>) unless informed otherwise by your scaffold provider. Those specifying scaffolds need to be clear about the duty rating required, eg an ‘inspection and very light duty’ scaffold should be 0.75 kN/m<sup>2</sup> whereas a ‘heavy duty’ scaffold should be 3.0 kN/m<sup>2</sup>.

146 Ensure you never sheet or attach debris netting to a scaffold without informing the supplier you are going to do so, as they will need to ensure the scaffold is designed for it.

147 Before using any scaffold, make sure that it is safe and suitable for the intended job:

- ensure platforms are fully boarded and wide enough for the work and for access (usually at least 600 mm wide);
- check that scaffold boards are properly supported and not overhanging excessively (eg no more than four times the thickness of the board);
- ensure there is safe access onto the work platforms, preferably from a staircase or ladder tower;
- check that loading bays are fitted with fall protection, preferably gates, which can be safely moved in and out of position to place materials on the platform; and
- make sure the scaffold is suitable for the task before it is used and checked whenever it is substantially altered or adversely affected, eg high winds.

### **Guard rails, toe boards and brick guards**

148 Guard rails, toe boards and other similar barriers should be provided to prevent falls whenever practicable (see Figure 10).

149 They should:

- be strong and rigid enough to prevent people from falling and be able to withstand other loads likely to be placed on them. For example, guard rails fitted with brick guards need to be capable of supporting the weight of stacks of bricks which could fall against them;
- be fixed to a structure or part of a structure capable of supporting them;
- include:
  - a main guard rail at least 950 mm above any edge from which people are liable to fall;
  - a toe board and brick guards where there is a risk of objects rolling or being kicked off the edge of the platform; and
  - a sufficient number of intermediate guard rails or suitable alternatives positioned so that the unprotected gap does not exceed 470 mm.

150 Barriers other than guard rails and toe boards can be used, so long as they are at least 950 mm high, secure and provide an equivalent standard of protection against falls and materials rolling or being kicked from any edges.

151 Brick guards are designed to prevent falls of material between the gaps in the guard rails and are not intended to protect against people falling. Therefore brick guards should always be used in addition to the required fall protection consisting of guard rails and toe boards or other similar barriers.

152 If the risk comes from falling through openings or fragile surfaces (eg roof lights or asbestos roof sheets), an alternative to guard rails or a barrier is to cover the opening or material. Any covering should be:

- strong enough to support any loads likely to be placed on it (including the weight of a person); and
- fixed in position to prevent accidental dislodgement. To prevent people removing coverings, mark them with a warning (eg 'Hole below – do not remove').

153 If possible, discourage passage across covers by directing people around them, eg using a high-visibility tape barrier.

### Tower scaffolds

154 Tower scaffolds (also known as mobile access scaffolds) are widely used and can provide an effective and safe means of gaining access to work at height while preventing falls. However inappropriate erection and misuse of tower scaffolds are the cause of numerous accidents each year. Aluminium towers are light and can easily overturn if used incorrectly. Towers rely on all parts being in place to ensure adequate strength. They can collapse if sections are left out.

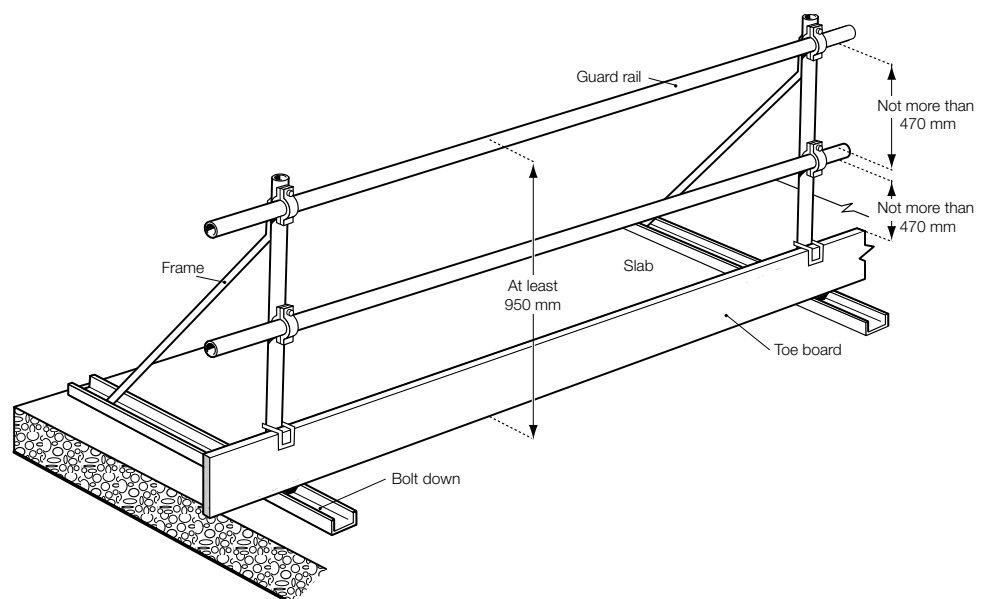

**Figure 10** Guard rails and toe boards

155 Before selecting or specifying a tower you must be satisfied that it is the most suitable item of equipment for the job. Tower scaffolds are more likely to be suitable for work either at single locations or at the same height at a series of locations, eg work to first floor windows. Tower scaffolds are more difficult to use safely for work that has to be done at varying height, eg underneath a sloping factory roof.

156 The manufacturer or supplier has a duty to provide an instruction manual that explains the erection sequence, including any bracing requirements and the height to which the tower can be erected safely. If the tower has been hired, the hirer has a duty to provide this information. This information must be passed on to the person erecting the tower.

157 Towers should be erected by trained and competent people who are following a safe method of work. There are two approved methods recommended by the Prefabricated Access Suppliers' and Manufacturers' Association (PASMA), which have been developed in co-operation with HSE.

158 The first method, an advanced guard rail system, makes use of specially designed temporary guard rail units, which are locked in place from the level below and moved up to the platform level. The temporary guard rail units provide collective fall prevention and are in place before the operator accesses the platform to fit the permanent guard rails. The progressive erection of guard rails from a protected area at a lower level ensures the operator is never exposed to the risk of falling from an unguarded platform (see Figure 11).

159 The second is the 'through-the-trap' (3T) method of erection. This method allows the person erecting the tower to position themselves at minimum risk during the installation of guard rail components to the next level. It involves the operator taking up a working position in the trap door of the platform, from where they can add or remove the components which act as the guard rails on the level above the platform. It is designed to ensure that the operator does not stand on an unguarded platform, but installs the components to a particular level while positioned within the trap door of that same level. The 3T method makes use of standard tower components (see Figure 12a-b).

160 If a tower scaffold is used:

- make sure it is resting on firm level ground with the locked castors or base plates properly supported – never use bricks or building blocks to take the weight of any part of the tower;
- install stabilisers or outriggers when advised to do so in the instruction manual;
- provide a safe way to get to and from the work platform, eg using an appropriately designed internal ladder;
- provide edge protection (guard rails and toe boards) on all working platforms and platforms used for storing materials.



**Figure 11** Advanced guard rails

161 The stability of any tower is easily affected. Unless the tower has been specifically designed for such use, activities such as those listed below should never be carried out:

- sheeting or exposure to strong winds;
- carrying out grit blasting or water jetting; or
- using the tower to hoist materials or support rubbish chutes.

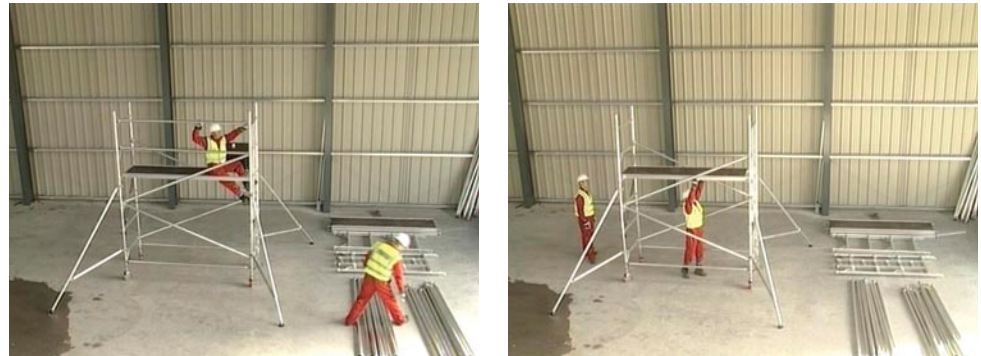

**Figure 12a and b** Through the trap

162 If ties are needed, check that they are put in place as required when the scaffold is erected and that necessary ties are kept in place when the scaffold is dismantled.

163 When erecting tower scaffolds:

- do not exceed the safe height-to-base ratio in the instruction manual. Towers should never be erected to a height not recommended by the manufacturer;
- do not use the working platform as a support for ladders, trestles or other access equipment;
- do not overload the working platform;
- do not fix ties to the centres of thin-walled aluminium tubes;
- do not climb up the rungs on the end frames of the tower to reach the platform unless the rungs have been specifically designed for the purpose of getting to and from the working platform – these have rung spacings of between 230 and 300 mm and an anti-slip surface.

164 When moving a mobile tower:

- reduce the height to a maximum of 4 m;
- check that there are no power lines or overhead obstructions in the way;
- check that the ground is firm, level and free from potholes;
- never move it while there are people or materials on the tower.

165 When towers are used in public places, extra precautions are required:

- erect barriers at ground level to prevent people from walking into the tower or work area;
- minimise the storage of materials and equipment on the working platform;
- remove or board over access ladders to prevent unauthorised access if they are to remain in position unattended.

166 To prevent the use of incorrectly erected or damaged tower scaffolds, they must be inspected regularly by a competent person. A new inspection and report is not required every time a tower scaffold is moved to a new location. However, if



guard rails or other components have to be removed to enable the tower scaffold to be moved past an obstruction, then a pre-use check should be undertaken by a trained and competent user to make sure the tower has been reinstated correctly. In this situation, the use of a visible tag system (which can be updated each time a check is carried out) to supplement inspection records is one way of recording that the pre-use check has been undertaken.

167 For details of the inspection and recording requirements, see paragraphs 131-139 and the reverse of the inspection form at Appendix 1.

### **Mobile access equipment**

168 Where it is not possible to avoid work at height or work from an existing structure, mobile access equipment, including mobile elevating work platforms (MEWPs) and mast climbing work platforms (MCWPs), can be used to prevent falls.

#### **Mobile elevating work platforms (MEWPs)**

169 MEWPs can provide excellent safe access to high-level work that can be easily moved from one location to another.

170 The three basic types of MEWP are:

- scissor lift (which gives a vertical lift only);
- telescopic boom (which gives vertical lift and outreach and is generally known as a 'cherry picker');
- articulating and telescopic boom (which are usually vehicle mounted and used for specialist activities such as bridge repair).

171 Before a MEWP is used you must assess the risks of people falling from or being thrown from the carrier, or the MEWP overturning, and take precautions to eliminate or control those risks.

172 Before work starts make sure that:

- the work is properly planned;
- the operator is fully trained and is familiar with the performance and controls of the specific type of MEWP they are going to use;
- there is a current report of thorough examination for the equipment;
- the machine is fitted with an emergency stop at ground level which can be deployed if the carrier becomes trapped against a fixed structure;
- the work platform is provided with guard rails and toe boards or other suitable barriers;
- it is used on firm and level ground, which may have to be prepared in advance and any temporary covers are strong enough to withstand the applied pressure;
- the daily inspection has been completed;
- any outriggers are extended and chocked as necessary before raising the platform;
- areas of the site where people may be struck by the platform or falling materials have been barriered off;
- other vehicles, such as delivery vehicles and dumpers etc, are segregated from the work area;
- the equipment is protected from adverse weather. High winds can tilt platforms and make them unstable. Establish a maximum safe wind speed for operation. Storms and snow falls can also damage platforms, so they should be inspected before use after severe weather; and
- everyone knows what to do if the machine fails with the platform in the raised position.

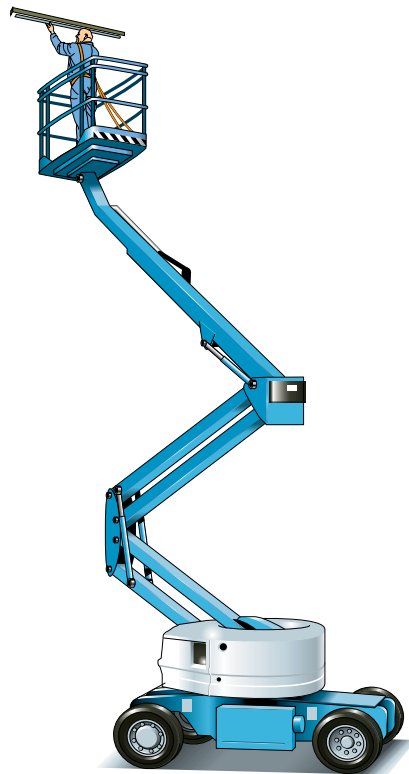

**Figure 13** A mobile elevating work platform

173 When using MEWPs:

- do not operate MEWPs close to overhead cables or other dangerous machinery;
- do not allow people to climb out of the carrier to reach their work position;
- do not allow a knuckle, or elbow, of the arm to protrude into a traffic route when working near vehicles;
- do not move the equipment with the platform in the raised position unless the equipment is designed to allow this to be done safely (check the manufacturer's instructions).

174 At the end of each day check that:

- the platform is cleared of tools and equipment;
- all power has been switched off and the keys have been removed from the machine;
- the equipment is secured where it will not be accessible to vandals or trespassers; and
- the machine log has no record of any faults, malfunctions, repairs or maintenance requirements.

175 Some MEWPs are described as suitable for 'rough terrain'. This usually means that they are safe to use on some uneven or undulating ground, but check their limitations in the manufacturer's handbook before taking them onto unprepared or sloping ground.

176 If there is still a residual risk of impact or people falling after you have assessed the risks and put control measures in place, then the use of fall protection equipment should be considered, eg:

- when working next to or in a live highway (eg street lighting work) where there is a risk of a vehicle hitting the MEWP;
- when traveling with the carrier in a raised position where it may strike fixed objects in its path (eg branches, steel work);
- when traveling with the carrier in a raised position over uneven ground;
- during steel erection where the carrier has to move in and around the steelwork.

177 In practice, wearing a harness with a short work-restraint lanyard provides the most suitable form of personal fall protection as it stops the wearer from getting into a position where they could fall from the carrier in the first place (unless it is a MEWP overturn). In this system, the harness does not normally have shock-absorbing capability and must be fixed to a suitable anchor point inside the basket.



**Figure 14** A mast climbing work platform

178 MEWPs are versatile machines that can be used throughout the life of a project. When undertaking refurbishment work or when you have reached the fit-out stage of a project, you may consider using a MEWP to provide safe access to height. MEWPs that can fit through a normal-width doorway and can be moved from floor to floor using the lift installed in a building are available for indoor use. Always check the safe working load of the lift against the weight of the MEWP (including people and equipment) before transporting it in this way.

#### ***Mast climbing work platform (MCWPs)***

179 This equipment is often used when carrying out repairs to (or refurbishment of) high-rise buildings. MCWPs are designed to provide access to working positions – they are not designed to act as material hoists.

180 Only specialists should erect, alter or dismantle mast platforms. It is particularly important that the correct sequence is followed. Serious accidents have occurred when ties have been removed or outriggers have not been properly extended during alterations.

181 A great advantage of using MCWPs is that those using them can be protected from adverse weather as many types can be provided with screens and a roof to the platform. However, enclosures to platforms can increase wind loads so the supplier must always be consulted before fixing them. High winds can make platforms unstable so consult the supplier to establish a maximum safe wind speed for operation. Storms and snowfalls can also damage platforms, so they should be inspected before use after severe weather.

182 When MCWPs are used, make sure:

- a handover certificate is provided by the installer. The certificate should cover how to deal with emergencies, operate, check and maintain the equipment, and should state its safe working load;
- there is a current report of thorough examination for the equipment;
- masts are rigidly connected to the structures against which they are operating and outriggers are used when necessary;
- working platforms are provided with suitable guard rails and toe boards;
- the controls only operate from the working platform; and
- the area below the platform is barriered off to prevent people from being struck by the platform or by objects that may fall from the platform.

183 At the end of each day check that:

- the platform is cleared of tools and equipment;
- all power has been switched off and, where appropriate, power cables have been secured and made dead; and
- the machine log has no record of any faults, malfunctions, repairs or maintenance requirements.

### **Suspended access equipment**

184 Where it is not possible to use mobile access equipment, suspended access equipment can be used. This enables the worker place themselves in the position required to carry out the work and includes suspended access cradles and boatswain's chairs.

#### ***Suspended access cradles***

185 Accidents happen during installation, use and dismantling of temporary cradles. Most accidents happen because of:

- unsafe access to and from the cradle;
- insufficient or poorly secured counterweights and holding-down systems;
- failure of the cradle platform or components such as drop-nose pins and bolts;
- failure of winches, climbing devices, safety gear and ropes, usually as a result of poor maintenance; and
- failure to follow the manufacturer's instructions on erection and dismantling.

186 Equipment should be selected, installed, thoroughly examined and tested to ensure that it is suitable for its intended purpose. Cradles should only be used by suitably trained and competent workers.

187 When using cradles check that:

- the cradle has adequate guard rails and toe boards and material cannot fall from or through the cradle's base;
- the equipment is capable of fitting closely to the building and where buffers or rollers are fitted, they will run against suitable features on the building;
- the building is capable of carrying the loads placed upon it, particularly under the counterweights and under the fulcrum (or pivot point) of the outrigger. The advice of a structural engineer may be needed;
- jib spacing matches the cradle length and, when the cradle can move, adequate stops are provided to prevent the cradle running off the end of the track;
- jib length and counterweights are specified to give a factor of safety against overturning of no less than three;
- a secondary safety rope fitted with a fall arrest device is provided and used;
- adequate operating instructions and technical support are available. If the equipment is hired, the supplier should be able to advise;
- the cradle is not overloaded and loads are placed on the platform as uniformly as possible;
- there is safe access into the cradle. Access at ground level is safest. If access is from the roof, the cradle should be secured to prevent it swinging away from the building. Access must be possible without the need to climb up or down the suspension ropes. If access is from the roof, or other raised platform, suitable means to prevent falls from roof edges will be required (eg guard rails and toe boards); and
- there is a plan for rescuing the operator if there is a cradle fault while at a high level.

188 Even where these precautions have been taken, accidents are still possible. For example, if the motor on a powered cradle fails, it can make the cradle tip, or people may overbalance and fall while reaching out of the cradle. Safety harnesses can save lives in these circumstances. Harnesses should be attached to specially designed anchorage points which have been installed in the cradle by the manufacturer. The harness lanyards should be kept as short as possible, while allowing operators to reach their place of work. For further advice on the use of harnesses, see paragraphs 204-217.

189 It is important that a thorough visual pre-use check for obvious faults is carried out before each use. In addition, a weekly inspection should be carried out by a competent person and a record made of that inspection. Before taking a temporary scaffold access platform into use, the following should be checked daily:

- the platform should be structurally sound – lift it off the ground, say 1 m, and inspect for excessive deflections;
- while it is off the ground, carry out a tactile inspection of critical connectors;
- make sure that it runs freely up and down – try it out; and
- check that lines of communication work properly.

190 At the end of each day, check that:

- the platform is cleared of tools and equipment;
- all power has been switched off and, where appropriate, power cables secured and made dead;
- the equipment is secured where it will not be accessible to vandals or trespassers;
- the shift report has no entries reporting any malfunction etc.

### Boatswain's chairs

191 Boatswain's (or bosun's) chairs should only be used for light, short-duration work. They should only be used where the provision of a working platform or other mobile access equipment is not practicable. In general, use a chair that consists of a seat with a back, a central suspension point and a carrying point for tools.

192 Whether a chair or seat is used, the user should be attached to the suspension system by a harness and lanyard to protect against falls. Always ensure that the rope grab is compatible with the rope type, rope diameter and/or energy-absorbing lanyard in use.

193 A person in a boatswain's chair is suspended high above the ground and would be hard to reach if they required assistance. The risk assessment should include your arrangements in case of an emergency.

### Safety nets and soft landing systems

194 Safety nets and soft landing systems (eg fire-retarded polystyrene-filled bags, air bags etc) can be used as leading edge protection to mitigate the consequences and distance should a fall occur. They are not a substitute for the use of fall prevention measures but can be used in conjunction with them if the risk of a fall cannot be eliminated (see Figure 15).

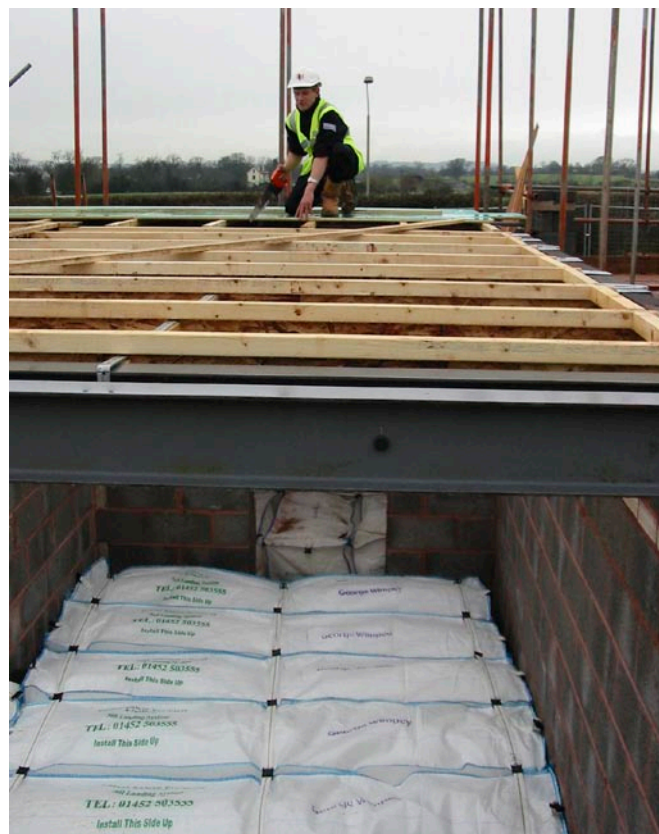

**Figure 15** Soft landing system

195 Nets are a complex energy-absorbing system, which should only be installed by trained and competent people. Before gaining access to height you must decide whether nets can be installed at ground level. It is often feasible to incorporate this into the steelwork design, and only if this is not possible should another means of gaining access to height be considered.

196 The way in which a safety net system is installed is critical and therefore this should only be undertaken by trained and competent people. Nets should be positioned as close as possible to the working level to minimise the height of a fall.

197 Safety net systems should be inspected by a competent person after installation and a handover certificate prepared to confirm their safety. They should then be inspected on a weekly basis to ensure they are still fixed correctly and will arrest a fall. When a person falls into a net, the material deforms as it absorbs the load and it is therefore essential to provide adequate clearance below the net to allow deformation to occur without the person striking the ground or another object. The net installer should be consulted when the net has been used to arrest a fall.

198 It is essential that your risk assessment covers your procedures for rescuing someone from a rigged net and for treating first aid while in the net, eg if someone strikes their head on structural steelwork during a fall.

199 Several different types of soft landing system are available as an effective alternative to nets. These systems can also be used in traditional house building (see paragraphs 249-250 on roof truss erection) and the contracting sector to reduce the risk of injury should a fall occur during the installation of floors or during roof work.

200 One system uses polystyrene-filled bags that are clipped together to completely fill the area beneath which work is being carried out. The depth of the bags both cushions and reduces the distance of a fall, which is effective in reducing injuries.

201 An alternative system uses air bags, and may be considered the most appropriate in the circumstances. Such systems require an air compressor, which maintains the pressure in the air bags so that they will absorb the energy of someone falling onto them without bouncing.

202 The installation and inspection of any soft landing system is critical and must only be undertaken by trained and competent people working to manufacturer's instructions.

### **Rope access techniques**

203 This technique can be used for inspection and other similar activities but not for general construction work. It should only be used where an access technique from higher up the hierarchy cannot be used. Check that:

- the equipment is erected and used under the supervision of a competent person and then a pre-use check is carried out;
- anyone using the technique has been trained and is competent;
- safe descent does not depend upon a single suspension point. The working line and safety line should be attached to two separate suspension points;
- all the equipment is checked carefully before each use and maintained to a high standard;
- any tools which are needed for the work are attached to the operator with a suitable lanyard, eg a rope or chain, so that they cannot be dropped; and
- where a risk of dropped tools or falling materials remains, the area beneath the work should be fenced off or protected by fans, covered walkways or similar.

## Safety harnesses

204 If work at height cannot be avoided, putting measures in place to prevent falls should always be the first consideration. If falls cannot be prevented by using work equipment that protects all those at risk (independent scaffolds, tower scaffolds and MEWPs), consider using work equipment that mitigates the consequences if an individual falls.

205 Fall-protection equipment can prevent people falling when it is used as a work-restraint system. When used in this way, the lanyard is kept as short as possible while allowing operators to reach their place of work. This prevents them from getting into a fall position, as they are physically unable to get close enough to the open edge (see Figure 16). Using a harness in this way is acceptable for light short-duration work and for inspection and maintenance purposes. In some cases a permanent or temporary horizontal lifeline could allow safe working. A harness can also be used as a work restraint when working from MEWPs or cradles.



**Figure 16** A work-restraint harness

206 There may be occasional circumstances where people still have to approach an open edge from which they would be liable to fall and having worked through the hierarchy of control, it is not practicable for any safer system to be provided. A harness should only be used to arrest a fall as a last resort. One of the problems with using fall arrest equipment is that it only protects a person if they wear the harness properly and connect the lanyard to a secure anchor point. Harness systems should not be used unless a suitably positioned and fully secure anchorage is specified. The use of any such system requires a high degree of training, competence and supervision.

207 Inertia reels are self-retracting fall-arrest devices. They are designed such that a steel cable or material webbing line pays out and is retracted automatically as the user moves around. Should a fall occur, a braking mechanism stops the line paying out and locks it to arrest the fall, similar to the operation of a car seat belt. They should only be used with an overhead anchor within a 30-degree cone under the anchor. If anchored in any other way, eg at foot level, the user's instructions or the manufacturer/supplier should be consulted to determine whether this is safe. Additional forces are generated with foot-level anchorages, as a person will fall further. The unit may not be capable of coping with such additional forces. Foot-level anchorage may cause the line to go over a sharp edge in the event of a fall; this could also cause the system to fail.



208 Harnesses and lanyards are made of man-made fibres and as such are prone to degradation by sunlight, chemicals, abrasive particles etc. It is important to carry out tactile pre-use checks daily, in good light, before taking harnesses and lanyards into use. If there is the slightest doubt about a harness or lanyard, do not use it. Faults can be noticed by discolouration, little tears and nicks, grittiness to touch etc. After use, harnesses and lanyards must be allowed to dry before being stored in a clean area.

209 Make sure everyone who uses a harness knows how to check, wear and adjust it before use and how to connect themselves to the structure or anchor point as appropriate.

210 A suitably qualified person must supervise the installation of equipment to which harnesses will be fixed, eg a suitable anchor.

211 Always minimise the free-fall distance. Keep your anchor point as high as possible to reduce the fall distance and ensure that there is an adequate clearance to allow the system to deploy and arrest the fall.

212 Anyone who needs to attach themselves should be able to do so from a safe position. They need to be able to attach themselves before they move into a position where they are relying on the protection provided by the harness.

213 A person may be injured by the impact loading on the body or by the 'pendulum effect'. This is when the faller swings like a pendulum striking the structure, the ground, or other obstacles. To reduce the risk of injury, a fall arrest system should always contain energy absorption.

214 Using designed temporary horizontal lifelines or inertia reels can provide extra free movement. Any attachment point must be capable of withstanding the impact load in the event of a fall and have an appropriate factor of safety – expert advice may be needed.

215 Consider how to recover anyone who does fall. It is not appropriate to rely on the emergency services as they might not arrive in time or might not have the necessary equipment to carry out a rescue.

216 A twin-tailed lanyard may be necessary in some cases where the wearer needs to move about. It is important that anyone who uses this system knows that when one of the lanyard legs is connected to the anchor point, the second leg is not attached to the user's harness as this could limit the extension of the energy absorber in the event of a fall.

217 Harnesses should be subject to a detailed inspection, which for arduous use should be carried out at least every three months.

### **Ladders and stepladders**

218 Ladders and stepladders are among the most commonly used pieces of access equipment on site and perhaps the most misused. Where work at height is necessary you need to justify whether a ladder or stepladder is the most suitable equipment compared to other access equipment. This is done by following the hierarchy of control (see paragraph 120) and using risk assessments.

219 Make certain there is no safer means of access before using a ladder or stepladder, even for short-duration work. Many accidents result from using ladders for a job when a tower scaffold or MEWP would have been safer and more efficient.

220 If the assessment indicates that more suitable equipment is not justified, a ladder or stepladder may be used:

- for short-duration work (15-30 minutes in one position depending on the risk assessment);
- for light work (they are not suitable for strenuous tasks which may involve carrying materials or supporting components, eg guttering); and
- if a secure handhold is available.

221 On a ladder or stepladder:

- do not overload it – the person and their equipment should not exceed the highest stated load;
- do not overreach – keep your belt buckle inside the stiles and both feet on the same rung (see Figures 17a-b).

222 Check the ladder is secure. Almost half of the accidents involving ladders happen because the ladder was not prevented from falling or slipping. The options for securing a ladder are as follows:

- tie the ladder to a suitable point, making sure both stiles are tied (see Figures 18a-c);
- where this is not practicable, use an unsecured ladder supplemented with an effective ladder stability device (eg a ladder stay and anti-slip device). Such devices must ensure that the ladder does not run sideways, slide away from the wall or rotate about a stile;
- securely wedge the bottom of the ladder to prevent it sliding, eg against a wall;
- footing the ladder is the last resort and should be avoided by the use of other access equipment.



**Figure 17a** Incorrect - overreaching and not maintaining three points of contact

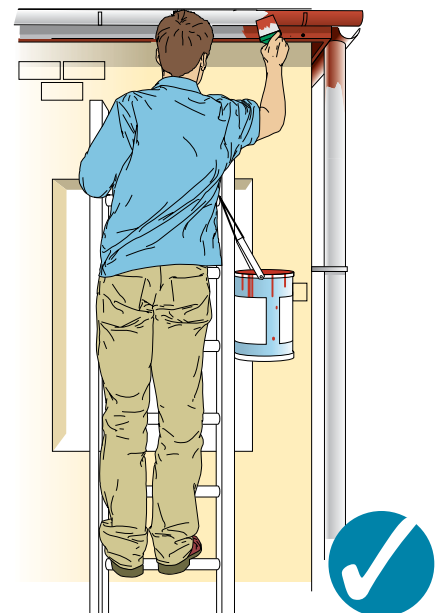

**Figure 17b** Correct position

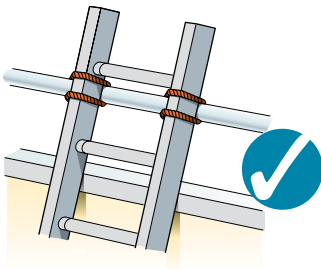

**Figure 18a** Ladder tied at top stiles (correct for working on, not for access)

223 Ladders used for access to another level should be tied and extend at least 1 m above the landing point to provide a secure handhold.

224 Stepladders are not designed for any degree of side loading and are relatively easily overturned. When working on stepladders, you should avoid work that imposes a side-on loading (such as side-on drilling through solid materials, eg bricks or concrete) by having the steps facing the work activity. Where side-on loadings cannot be avoided you should prevent the steps from tipping over, eg by tying the steps to a suitable point. Otherwise a more suitable type of access equipment should be used.

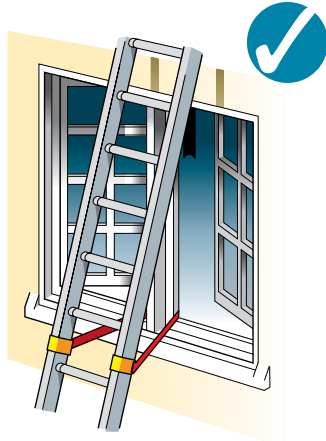

**Figure 18b** Tying part way down

225 Make sure light tools are carried in a shoulder bag or holster attached to a belt so that both hands are free for climbing. Heavy or bulky loads should not be carried up or down ladders – a gin wheel or other lifting equipment should be used instead (see paragraphs 316-337).

226 For safe use the ladder or stepladder needs to be strong enough for the job and in good condition. Domestic ladders are unlikely to be robust enough for use in construction work. Ladders should have a pre-use check each working day and a current detailed visual inspection, which has been carried out in accordance with the manufacturer's instructions and recorded. Ladders that are part of a scaffold system must be inspected every seven days.

227 As a guide, when using ladders and stepladders:

- check the stiles are not damaged, buckled or warped, no rungs are cracked or missing and the feet are in good repair and clean;
- do not use home-made devices or equipment made for the DIY market, these are not strong enough for site work and should be avoided;
- never try to repair damaged equipment;
- ensure they are resting on a firm, level surface. Never place them on loose bricks or packing;
- where a ladder is put up at an angle to minimise the risk of slipping outwards, as a rule of thumb the ladder needs to be 'one out for every four up' (see Figure 19);
- make sure the top of the ladder rests against a solid surface. Ladders should not rest on fragile or other insecure surfaces such as cement sheet or plastic guttering (you may find a spreader bar or stand-off device useful);
- ensure they are long enough:
  - for ladders, don't use the top three rungs;
  - for stepladders, don't use the top two steps unless a suitable handrail is available (see Figure 20a);
  - don't use the top three steps of a swing-back or double-sided stepladder where the step forms the very top of the stepladder (see Figure 20b);
- ensure the restraint devices on stepladders can be fully opened and any locking devices are engaged.

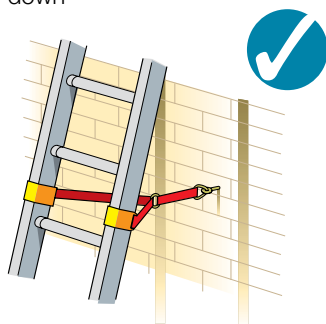

**Figure 18c** Tying at base

228 Even when measures are taken to reduce the risk of falling, working from a ladder can still be dangerous – many accidents happen during work lasting less than 30 minutes. It is crucial that ladders and stepladders are only used when you are certain there is no safer means of access.

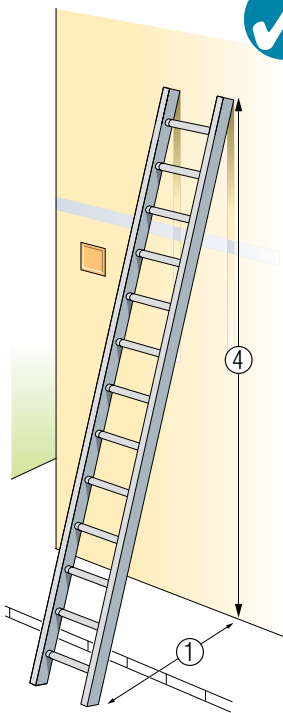

**Figure 19** Ladder showing correct 1 in 4 angle (means of securing omitted for clarity)

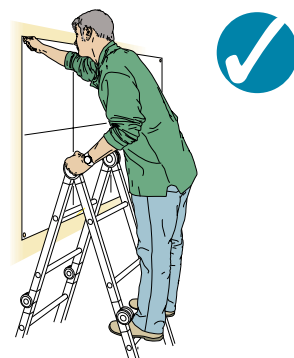

**Figure 21** Podium steps

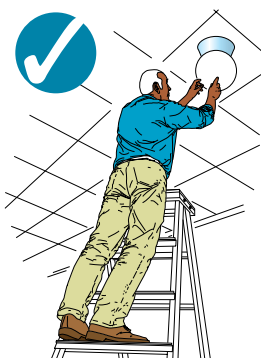

**Figure 22** Working platform stepladder

### Roof work and fragile surfaces



**Figure 20a** Correct – two clear rungs



**Figure 20b** Correct – three clear steps

230 Almost one in five workers killed in construction accidents are doing roof work. Some are specialist roofers, but many are simply involved in repairing and cleaning roofs. The main causes of accidents are falling off the edges of roofs and falling through holes, roof lights and other fragile surfaces.

231 Compliance with well-established safety procedures and existing legislation could save lives and prevent injuries. All roof work requires a risk assessment and, if the work is extensive, a method statement that sets out a safe system of work. Most accidents could be avoided if the most suitable equipment was used and those carrying out the work were given adequate information, instruction, training and supervision.

232 If work is going to be done on any roof, make sure there is:

- safe access onto the roof, eg a general access scaffold, tower scaffold (preferably of the stairway design) or mobile access equipment etc;
- a safe means of moving across the roof, eg using proprietary staging or purpose-made roof ladders;
- a means of preventing falls when working on the roof, eg edge protection consisting of guard rails and toe boards, a proprietary access system or a MEWP etc; and
- measures to prevent falls through fragile materials (eg barriers or covers) and mitigate the consequences should a fall occur (eg nets).

233 Independent scaffolds that provide safe access onto the roof, a safe working platform and the capacity for material storage (always check with the scaffold designer before stacking material at roof level) are the ideal solution.

234 However, it is not always possible to use a general access scaffold. In these circumstances, for a sloping roof, edge protection erected at eaves level, with or without a scaffold platform, or for a flat roof, edge protection erected around the edges provides an alternative fall prevention measure. Figure 23 shows some of the options for sloping-roof edge protection and Figure 24 shows examples of flat-roof edge protection.

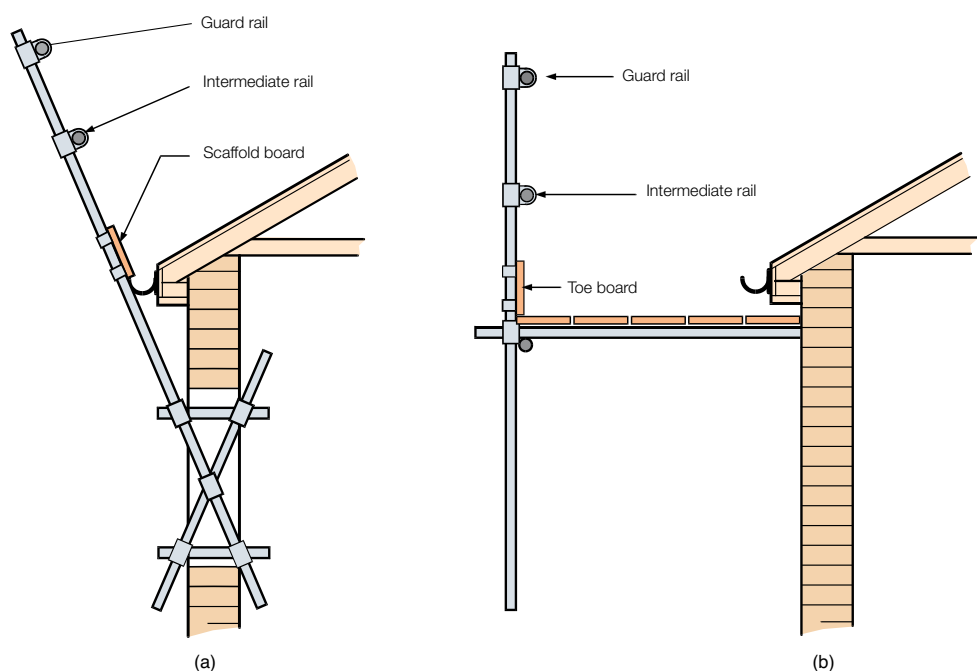

**Figure 23** Typical sloping-roof edge protection

235 Irrespective of the type of edge protection used, safe access onto the roof and a safe way of lifting materials up to roof level must be provided and maintained. The maximum load that should be carried up a ladder is 10 kg.

236 Alternatively, mobile elevating work platforms or proprietary access systems (see Figure 25), which are easy to transport from site to site and quick to erect, provide good access and should be considered as an alternative to fixed edge protection.

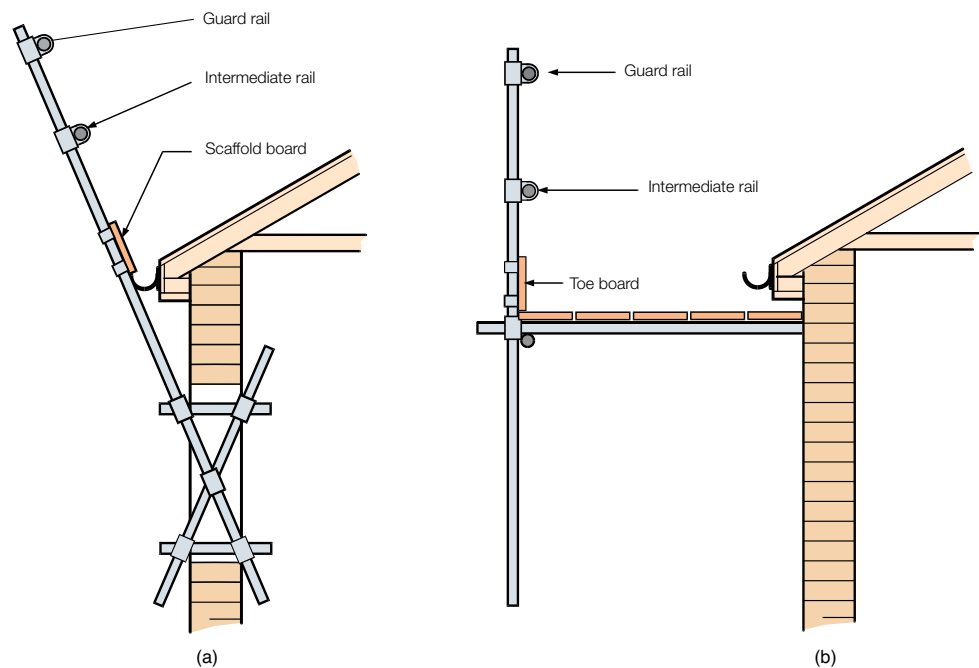

**Figure 24** Example of flat-roof edge protection

237 On sloping roofs, roof workers should not work directly on the tiles or slates. Roof ladders and proprietary staging should be used to enable safe passage across a roof. They must be designed for the purpose, of good construction, properly supported and if used on a sloping roof, securely fixed by means of a ridge hook placed over the ridge. They should be used in addition to eaves-level edge protection and if the work requires access with 2 m of the gable ends, edge protection will be needed there as well.



**Figure 25** Proprietary access system for roof-work

238 Short-duration work means tasks that are measured in **minutes** rather than hours. It includes such jobs as inspection, replacing a few tiles or adjusting a television aerial. Work on a roof is still dangerous even if it only lasts a short time and appropriate safety measures are essential.

239 For short-duration work it may not be reasonably practicable to provide full edge protection, but you will need to provide something in its place. The minimum requirements for short-duration work on a roof are:

- a safe means of access to roof level; and
- a safe means of working on the roof (eg on a sloping roof, a properly constructed roof ladder, or on a flat roof, a harness attached to a secure anchorage and fitted with as short a lanyard as possible).

240 Many roof assemblies are, or can become, fragile. Asbestos cement, fibreglass and plastic generally become more fragile with age. Steel sheets may rust. Sheets on poorly repaired roofs might not be properly supported by the purlins. Any of these materials could give way without warning. Do not trust any sheeted roof. Do not stand directly on any sheeted roof.

241 On fragile roofs, the work has to be carefully planned to prevent falls through the roof. All work should be carried out from beneath where practicable. Where this is not possible, consider using a MEWP, which allows the operatives to carry out the work from within the MEWP basket without standing on the roof itself (see Figure 26). **Never** try to walk along the line of the roof bolts above the purlins, or along the roof ridge, as the sheets can still crack and give way. The sheets are not designed to support your weight and you should therefore approach the roof as if the sheets were not in position.



**Figure 26** A mobile elevating work platform being used to replace a roof sheet

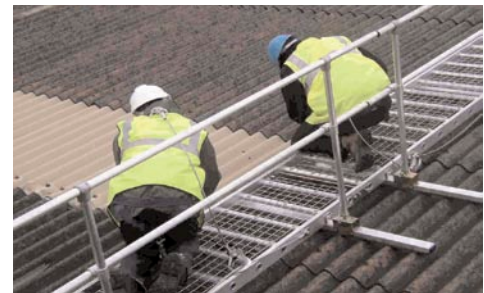

**Figure 27** Workmen wearing harnesses attached to a work positioning line, which is fitted to the staging

242 If access onto a fragile roof cannot be avoided, edge protection should be installed around the perimeter of the roof and staging should be used to spread the load. Unless all the work and access is on stagings or platforms that are fitted with guard rails, safety nets should be installed under the roof or a harness system should be used (see Figure 27).

243 Roof openings and fragile roof lights are a particular hazard. Some roof lights are difficult to see in certain light conditions and others may be hidden by paint. Protection from falling through openings and fragile roof lights must be provided using either barriers or covers that are secured or labelled with a warning. If the work is the replacement of roof lights, nets slung close beneath the roof lights, or a harness attached to a work positioning line which is fixed to the staging, provides protection should a fall occur.

244 Do not throw materials such as old slates, tiles etc from the roof or scaffold – someone may be passing by. Use enclosed debris chutes or lower the debris in containers (see paragraphs 555-558).

### Industrial roof work

245 Industrial roof work involves all the hazards already mentioned and in addition, falls from the 'leading edge' also need to be prevented. Leading edges are created as new roof sheets are laid or old ones are removed. Fragile and lightweight materials, such as liner trays which will buckle and give way under the weight of a person, can also be a problem and should be protected.

246 Work at the leading edge requires careful planning to develop a safe system of work, including measures to mitigate the distance and consequences of a fall. Work platforms or staging used in conjunction with nets is the preferred method, as nets provide protection to everyone on the roof. Nets should only be installed by trained and competent net riggers.

247 If this is not practicable, work platforms or staging (fitted with guard rails and toe boards) in advance of the leading edge can provide protection in some circumstances. However, these will need to be used in conjunction with harnesses attached to a work positioning line which is fixed to the work platform. If a harness is used, you must ensure that workers can attach themselves to the anchorage without putting themselves at risk of a fall. Using the harness in work-restraint mode is the preferred option, as this does not allow the operative to approach the leading edge and enter into a fall position. Close supervision of this system of work will be required as it is difficult for harnesses to remain clipped on at all times throughout the work activity.

248 When developing a safe system of work, also consider:

- how the first sheets will be laid – a separate platform may be required (a pack of roof sheets is not a safe working platform) – and how hip ends and other special details are to be fitted; and
- how sheets will be raised to roof level – decide what type of lifting machinery, such as a crane or an inclined hoist, will be the preferred method. This will eliminate unnecessary risks when placing packs of sheets on the roof supports or when breaking open packs spread over the roof supports.

### **Roof truss installation**

249 When installing roof trusses, their placement and associated bracing is a hazardous activity, which requires careful planning to ensure a safe system of access and protection against falls is implemented. You must provide a safe working platform around the perimeter of the roof together with measures to mitigate the distance and consequences of a fall should one occur. This can be achieved by providing a working platform or 'crash deck' immediately beneath the bottom members of trusses. Either conventional scaffolding or (if appropriate) proprietary plastic decking systems can be used for this. Alternatively, nets can be used providing a safe clearance distance can be achieved below the net and a suitable fixing point is available. Alternatives to the use of nets are the soft landing systems described in paragraphs 119-202. Providing nets or soft landing systems is particularly important when installing temporary bracing or before boarding out along the bottom chord of the trusses, where access within them is required.

250 For more information read *Health and safety in roof work*.<sup>9</sup>

### **Steel erection**

251 When designing and planning for the erection of steel frames, the first consideration should be to eliminate or reduce the need to work at height. Where work at height cannot be avoided, mobile elevating work platforms (see MEWPs, paragraphs 169-178) or tower scaffolds (see paragraphs 154-167) or other suitable working platforms should be used for access for bolting-up and similar operations. To allow safe use of mobile platforms or tower scaffolds and safe standing for a crane, make sure the ground is suitable before work starts.



252 Steel erection requires careful planning and execution – it is best left to the specialists. There is also much potential to reduce risks during design and planning by, for example:

- installing edge protection at ground level before steel members are lifted into position (Figure 28);
- ensuring erection is sequenced so that stairs and handrails can go in as early as possible to provide safe access to high levels of the structure;
- designing connection joints to make bolting-up easy;
- adding bracing, guys or stays into the design to ensure integral stability of the structure through all stages of erection;
- ensuring adequate information is passed on to inform erectors about special sequences that need to be followed to ensure stability.



**Figure 28** Edge protection installed with the steelwork

253 The main hazards to be controlled on site are:

- falls when working at height, including falls from delivery vehicles;
- erectors being hit by moving steel members or decking packs being craned into position;
- the structure collapsing before it is fully braced;
- materials dropping onto people working below;
- the manual lifting of heavy steel members, causing back and other strains and injuries; and
- cranes and MEWPs overturning.

254 Before work starts:

- plan for good access onto the site and proper standing areas for delivery vehicles, cranes, MEWPs and tower scaffolds;
- arrange for materials to be stored safely;
- programme work to make sure other trades do not have to work beneath the erectors, so avoiding the risk of them being injured by dropped materials;
- plan where and how the steelwork will be assembled before erection, minimising the number of connections to be made at height;
- arrange for safe working at height using MEWPs, tower scaffolds or another form of independent access together with nets or other measures to mitigate falls;
- ensure there is a sequential method of erection and check temporary bracing to ensure stability will be maintained at all times – consult the frame designer or a structural engineer;
- agree a safe method of work and ensure it is followed; and
- write a contingency plan for dealing with any emergencies which may arise.

255 There may be occasions where the work cannot be done from a MEWP or other platform and erectors may have to work from the steel. This is known as beam 'straddling'. This form of access is only permissible for specific short-duration jobs where the beam is of I beam section. Where workers are working from the steel, they must sit astride the flange with the sole and heel of each foot resting on the bottom flange and grasp either side of the top flange with both hands. A backup system must be in place to protect against falls. In many cases, this will be provided using a harness and a twin lanyard (see paragraph 216). When the safe system of work relies on harnesses, a system must be in place to rescue a person who may fall and be left suspended from their harness.

256 Walking on the top flange of steel beam is dangerous and must **never** be undertaken.

257 Workers can fall during the erection of the frame, or when decking sheets are being handled. People can fall:

- during the landing and splitting of decking packs;
- when decking sheets are being moved around the frame;
- during the laying of decking sheets; and
- from edges of decked areas (including leading edges).

258 To prevent these falls, assess the type of work being done (this will include the height of the building and height between floors etc) and plan a safe system of work to prevent falls. This may entail positioning decking sheets from mobile access platforms or tower scaffolds. In most cases, a safe system will require the use of nets under the working position to mitigate the effect of falls from the leading edge.

259 Position guard rails at all fixed edges and openings as early as practicable in the construction sequence. The safest way is to install edge protection to the steelwork before it is lifted into position.

260 The hazards associated with laying decking and the necessary precautions are similar to those required for safe working during industrial roofing. See paragraphs 245-248 for further details.

## Formwork and reinforced concrete structures

261 The main risks are:

- people falling during erection and striking of formwork and assembly of the steel frame;
- collapse of the formwork;
- materials falling while striking the formwork;
- manual handling of shutters, reinforcing bars etc;
- being struck by the concrete skip;
- silica dust and hand-arm vibration from scabbling operations;
- awkward postures and working positions for steel fixers;
- dermatitis and cement burns from wet concrete.

262 Many of these risks can be reduced or removed by design and careful planning:

- designers should consider the manual handling risks when detailing size and length of the reinforcing bar;
- fixing reinforcement steel in prefabricated sections in factory conditions and craning it into position so that work can be done on benches to reduce the need for bending down. Alternatively, using long-handled tools can reduce the need to bend over;
- using formwork systems that have edge protection and access designed in;
- minimising the need for scabbling by using retarders; and
- using concrete pumps instead of cranes and skips.

263 Make sure that:

- a method statement has been agreed before work starts, and that it is followed;
- guard rails or other suitable barriers to prevent falls are put in place as work progresses;
- workers have safe access to the work – it is not safe to stand on primary or other open timbers;
- a safe means of access is used. Many formwork systems have purpose-designed fittings to allow access platforms to be fitted and they should be used (see Figure 29);
- climbing up vertical sections of reinforcement or up the outside of column formwork is not permitted. A tower scaffold can provide safe access to columns (see Figure 30);
- equipment is in good order before use. Do not use substitutes for the manufacturer's pins in adjustable props;
- the formwork, falsework and temporary supports are checked, properly tied, footed, braced and supported before loading, and before pouring walls or columns;
- workers are protected from wet concrete (provide gloves and Wellington boots and proper washing facilities) and silica dust (provide respirators or avoid the need to scabble by using a retarder);
- loads are spread as evenly as possible on the temporary structure. Do not place large loads of timber, reinforcing bars or wet concrete in a localised area – spread loads evenly;
- it is known when back-propping is required and how soon the new structure can be loaded; and
- there is a planned safe dismantling procedure.

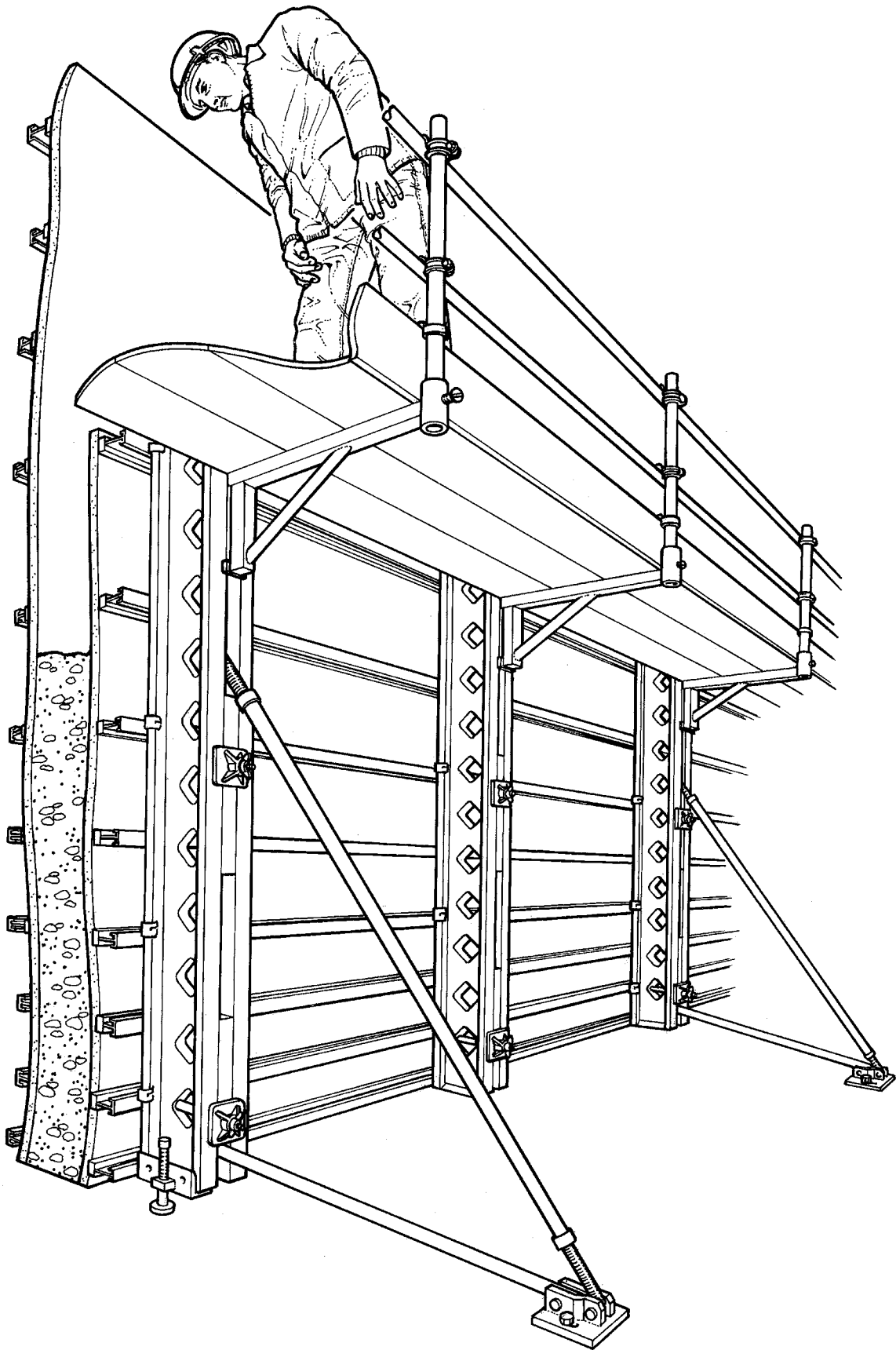
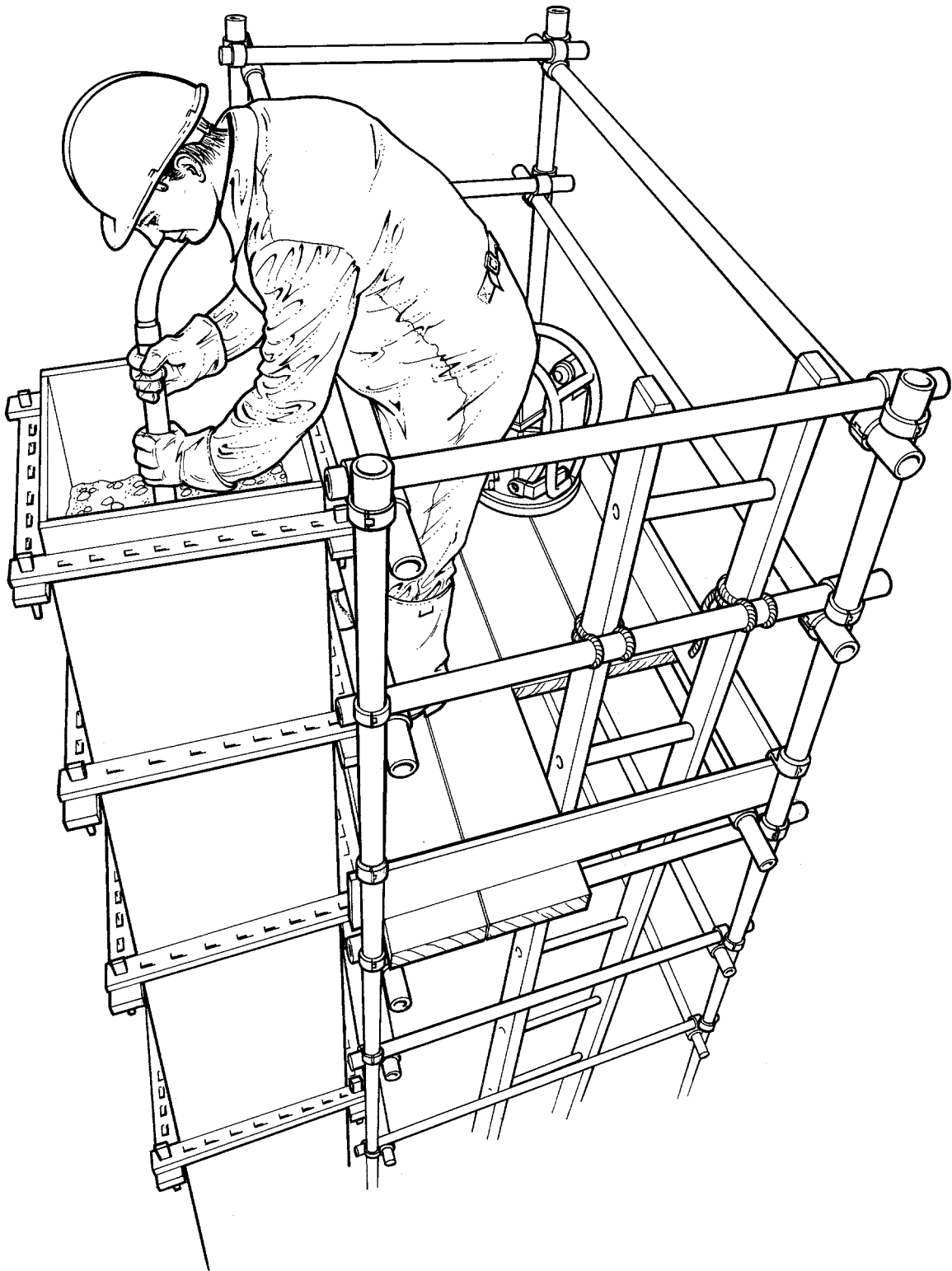

Figure 29 A formwork system with purpose-designed fittings



**Figure 30** A tower scaffold provides a safe means of access to the columns

# Site traffic and mobile plant

264 Every year, workers are killed on construction sites by moving vehicles or by vehicles overturning. Many more are seriously injured in this way. The risks can be reduced if the use of vehicles and mobile plant is properly managed.

## Site traffic

### *Plan and manage your site to minimise the number of vehicle movements*

265 Design groundworks/landscaping to minimise the need to import fill or take spoil off site. Try to reuse spoil close to where it was excavated to reduce the distance it has to be carried.

266 Limit the number of vehicles on site:

- provide car and van parking for the workforce and visitors away from the work area and strictly control parking within the work area;
- use gates or barriers etc to control entry into the work area and display the procedure for obtaining entry (eg a mobile phone contact number) (Figure 31);
- plan the location of stores/goods receiving areas carefully to reduce any need for delivery vehicles to travel through site. You may need to relocate those areas as the site progresses.

267 Consider ways, other than vehicles, of moving materials to where they will be used (eg self-erecting tower cranes). Such approaches can be particularly useful on sites with limited space available for access.

### *Plan and manage the routes on your site*

268 Set appropriate speed limits for the routes on your site. Sign the limits clearly and consider using physical measures to restrict speeds (eg road humps).

269 Reversing vehicles are a major risk. Wherever possible plan your site layout to avoid the need for vehicles to reverse:

- provide drive-in/drive-out access to delivery and work areas. You may need to add extra temporary roadways to the site's permanent road system and/or delay building parts of the project to allow exit routes from dead ends (Figure 32);
- where roadways are narrow, or are constricted by parked vehicles or stored materials, you may need to implement a one-way system;
- design storage compounds to allow drive-through deliveries and collections;
- where drive-through routes cannot be incorporated, provide turning circles to allow vehicles to turn round without reversing, or provide a 'hammerhead' or similar turning area. You will need to fence off any turning areas to exclude all pedestrians, and they should be kept free from obstructions and parked vehicles.

270 If vehicles have to reverse in areas where pedestrians can not be excluded you should ensure that:

- the driver has sufficient direct vision behind the vehicle to reverse safely; or
- the vehicle is fitted with appropriate reversing alarms, vision aids such as mirrors, CCTV etc; and/or
- a trained signaller is used to control the manoeuvre.

271 Plan to keep pedestrians and vehicles apart:

- provide separate entry and exit gateways for vehicles and pedestrians;
- provide firm, level, well-drained pedestrian walkways that are separated from vehicle routes and, as far as possible, take the most direct route (it is easier to make vehicles go the long way round);
- where walkways need to cross vehicle routes, provide a clearly signed, well lit crossing point. Make sure both drivers and pedestrians can easily see each other as they approach the crossing (Figure 33); and
- at site exits where vehicles may have to cross the public footway, ensure that vehicles leaving site can see both ways along the footway before they need to cross it by, eg constructing the site fence on either side of the gateway of welded mesh or other materials that do not obstruct vision, or setting the gateway back from the footway and angling the site fence to allow a wide field of view. If sufficient vision cannot be achieved, then a trained signaller should be used to control exiting vehicles (Figure 31).

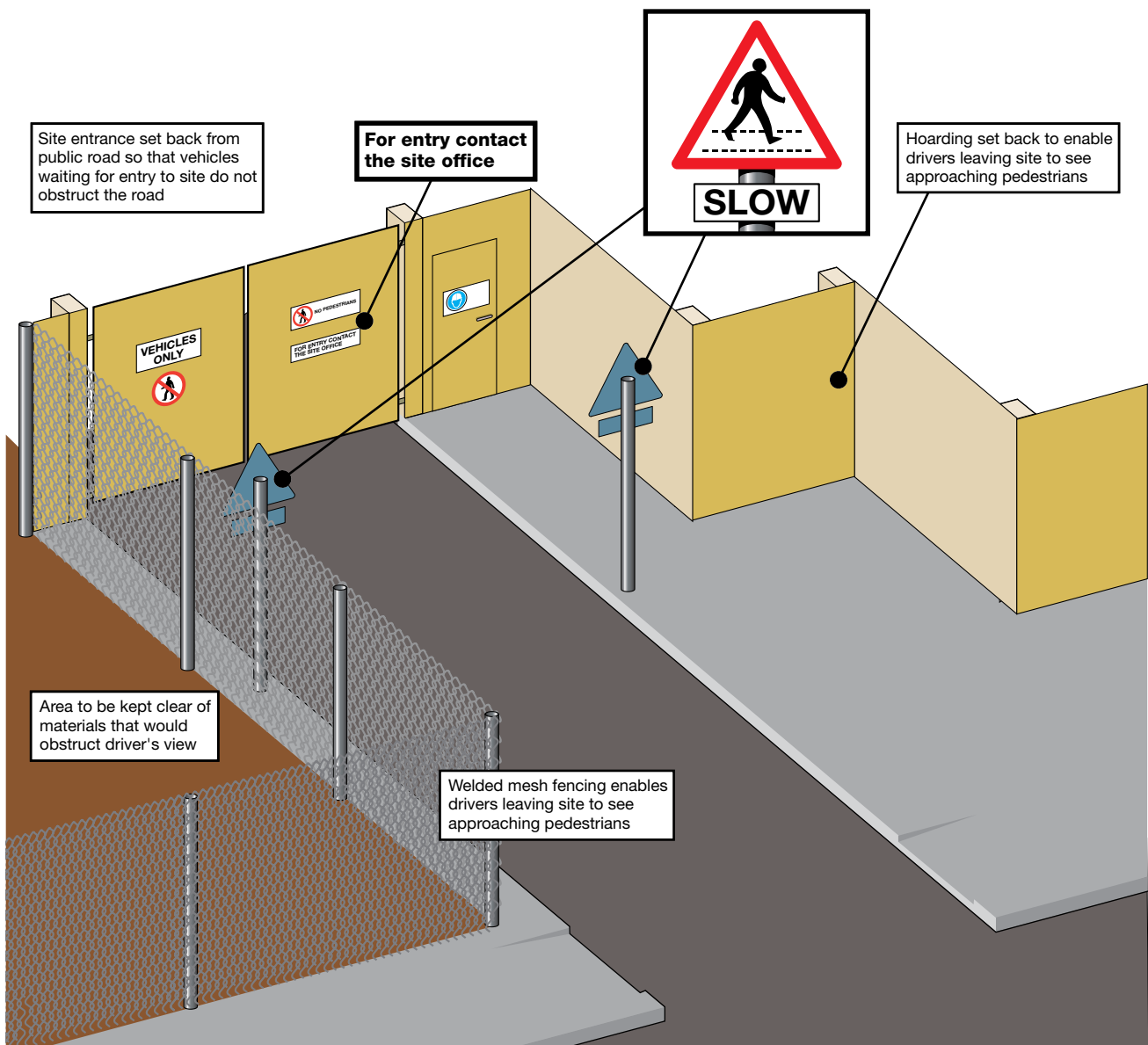

**Figure 31** Use gates or barriers etc to control entry into the work area and display the procedure for obtaining entry

272 Where vehicles and pedestrians need to share a route or working space:

- provide separate walkways alongside the vehicle route. Make sure the walkways are wide enough so that pedestrians can pass without stepping into the roadway;
- keep walkways clear of obstructions, excavations etc. If walkways have to be blocked, provide a safe diversion;
- consider separating the walkways from the roadways by at least a waist-high fence or barrier in areas of increased risk such as:
  - near loading bays, stockpiles, lorry unloading areas, storage areas and other places where reversing is likely to occur;
  - turning areas;
  - high traffic routes;
  - entrances and exits;
  - narrow roadways or walkways;
  - areas with restricted vision;
- in other areas it may be sufficient to use a raised kerb or marker posts to delineate the pedestrian and vehicle routes.
- take particular care at locations where pedestrians and vehicles are forced together. These locations may be permanent (such as gateways, bridges, ramps or gaps between buildings) or temporary, perhaps due to excavations or access equipment (Figure 34);
- make sure that drivers and pedestrians on shared routes can see each other easily; you may need to provide lighting after sunset or in bad weather. Pedestrians should wear high-visibility clothing;
- if it is necessary to undertake work on a vehicle route (eg repairing kerbs, accessing manholes or gullies etc) then treat it like work on a public road. Protect the work zone with barriers and provide advance warning signs and cones that are appropriate to the type and speed of the traffic.

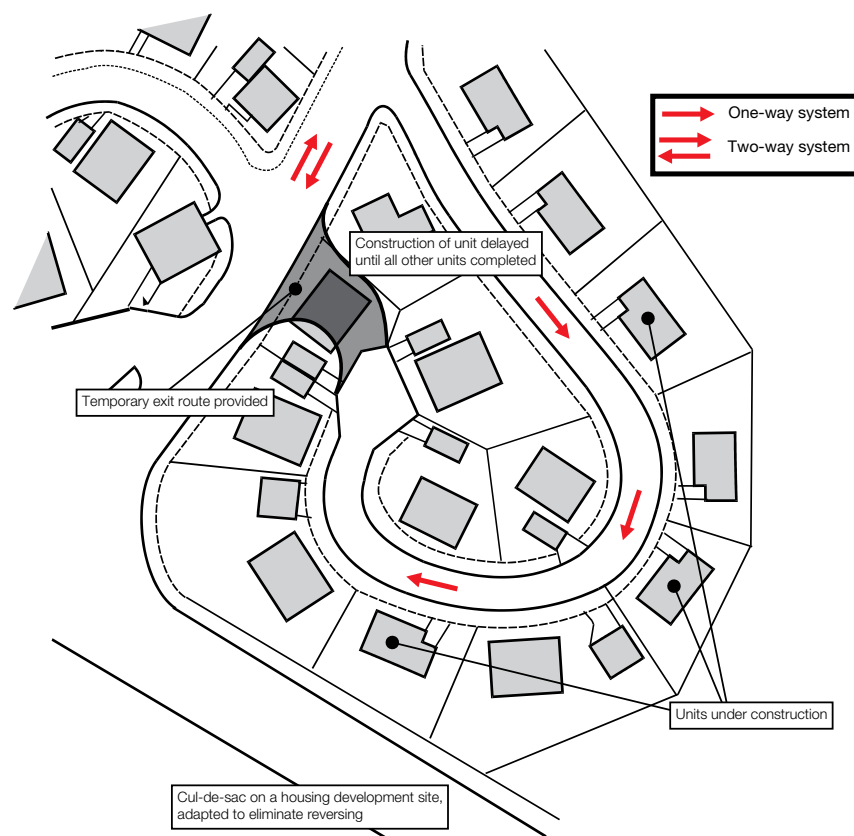

**Figure 32** Provide drive-in/drive-out access to delivery and work areas



**Signs and instructions**

273 Make sure that all drivers and pedestrians know and understand the routes and traffic rules on the site and provide induction training for drivers, workers and visitors.

274 Post plans showing the traffic routes at site entrances, site notice boards and in other places where workers can easily refer to them. Consider providing printed copies that can be marked up as necessary to guide delivery drivers. Update the notices and provide retraining if traffic routes or rules change.

275 Provide standard road signs to warn, guide and instruct drivers on site. In particular, make sure that routes for delivery drivers and site visitors are clearly signed.

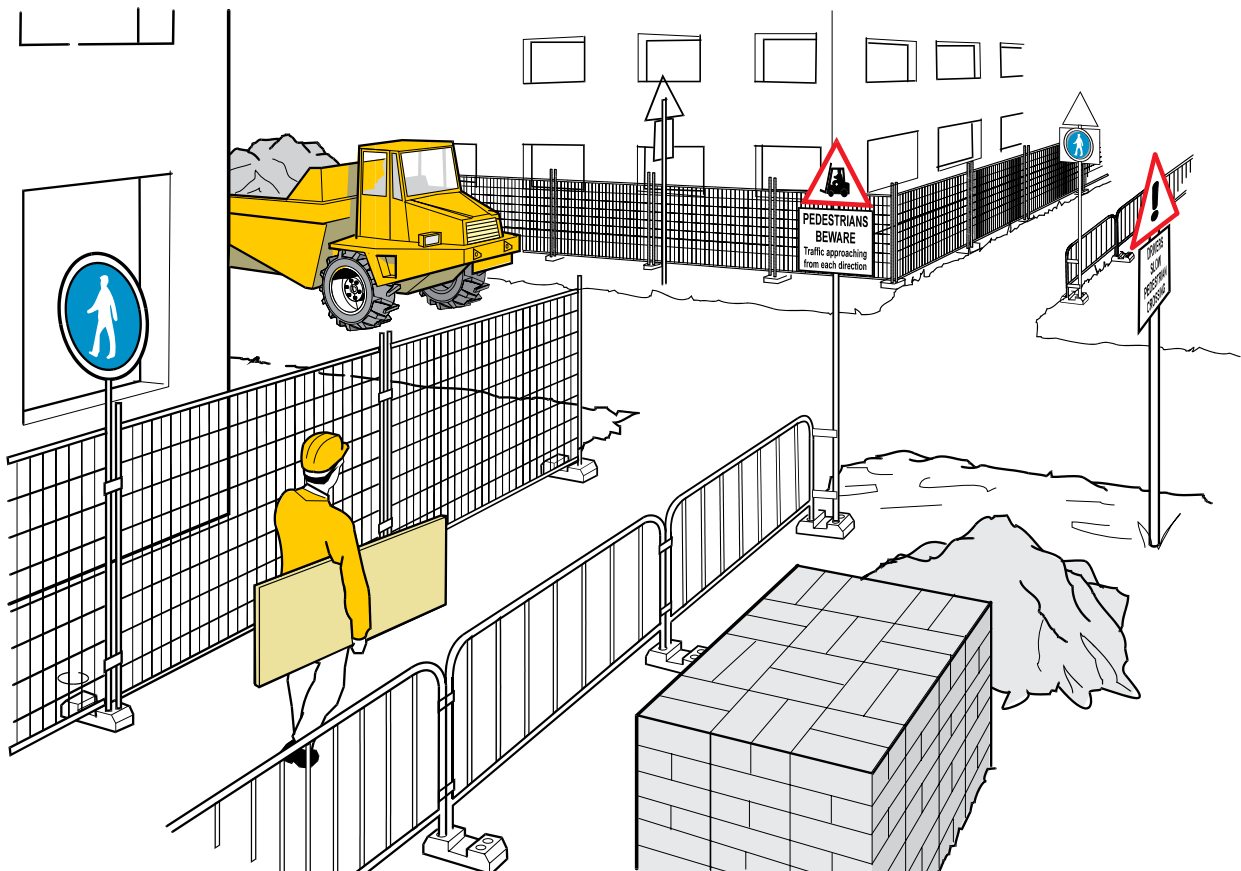

**Figure 33** Where walkways need to cross vehicle routes, provide a clearly signed, well-lit crossing point

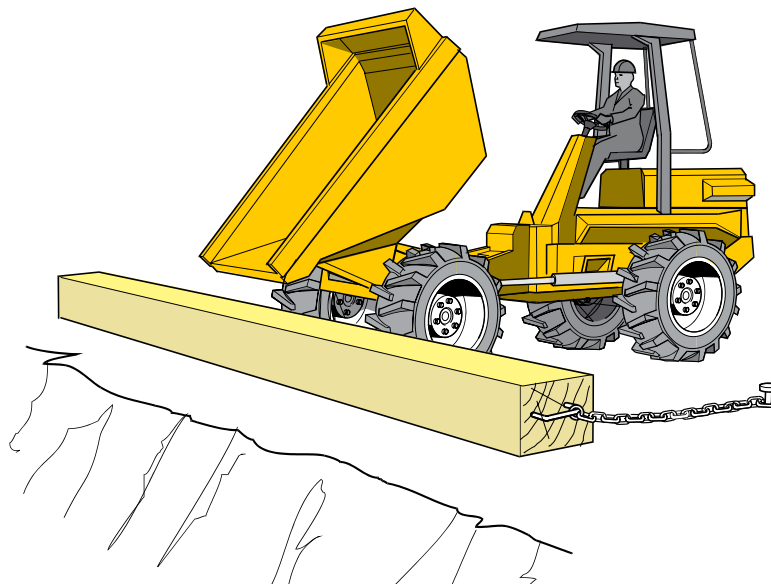

**Figure 34** Pedestrians are segregated from vehicles on this slope

## Work areas

276 The risks from working plant must be controlled:

- protect any temporary structures, such as scaffolds or falsework, which might be damaged and made unsafe if struck by a vehicle;
- protect any excavations and alongside any areas of water if vehicles may approach close by;
- take precautions, such as stop blocks, where vehicles tip materials into excavations (Figure 35);
- make sure vehicles are not overloaded as it may obstruct the driver's view and they may become unstable, difficult to steer or the brakes may be inadequate to stop the vehicle;
- segregate the area around plant that slews (eg 360° excavators and mobile cranes). Do not rely on the driver using mirrors, cameras etc to check that the slewing area is clear, as their attention will typically be concentrated on the machine boom or jib;
- if slewing plant is being used in a confined area where there is a risk of workers being trapped against adjacent obstructions (ie less than 0.5 m clearance), consider using a different type of machine that has zero or minimal tail swing. If alternative machines are not practicable, then secure fencing should be used to segregate the area and prevent access into the danger zone (Figures 36a-b).



**Figure 35** Take precautions, such as stop blocks, where vehicles tip materials into excavations



**Figure 36** Minimal tail swing

277 Many workers, including drivers, are injured when vehicles unintentionally move:

- park vehicles on level ground. Avoid parking or stopping any vehicle on a slope, handbrake malfunctions are a common contributor to run-away accidents;
- certain types of construction plant can drive up slopes that are steeper than the vehicle's normal handbrake can hold them on – check safe slopes with the vehicle supplier; and
- turn off the engine before leaving a vehicle. There have been numerous incidents where drivers have accidentally operated control levers while climbing in or out of the vehicle. Leaving the engine running also encourages unauthorised use.

## **Vehicles and plant**

### **Selection**

278 For any particular task there is often more than one item of plant or type of vehicle that could undertake it. Selecting the right plant or vehicle can make the job significantly safer.

279 Select the size of plant or vehicle carefully. If it is too small there can be a temptation to overload the machine and it may not have sufficient stability. If it is bigger than necessary it is likely that it will be more difficult to manoeuvre and the driver will have less visibility.

280 Select the type of plant carefully. In congested areas or where it is not possible to exclude pedestrians, consider using a zero tail swing 360° excavator, or a 180° excavator (backhoe loader). Tracked dumpers have better stability on slopes and on soft ground than wheeled dumpers.

281 Many construction vehicles have significant blind spots (areas that the driver cannot see) in various locations around the vehicle. In some cases this can create risks to both nearby pedestrians and to the vehicle when the vehicle is moving. Any load that the vehicle is carrying can create temporary blind spots.

282 Select vehicles with the best view around them directly from the driver's position. Often it is the more recent models that have better direct vision.

283 Avoid fitting additional components onto a vehicle in positions that obstruct the driver's view, eg racks to carry security grilles or supplementary exhaust filters.

284 Some vehicles are fitted with vision aids such as mirrors or CCTV, which help drivers to see areas that they cannot view directly. If these aids are fitted make sure they are working, properly adjusted and that the driver has been instructed in their use (Figure 37).

285 If the driver has restricted direct vision to the rear, the vehicle should be fitted with a reversing warning signal.

286 Driver vision, vision aids and warning signals should never be used as the only precaution. The precautions from site management, planning and layout should be fully implemented first.

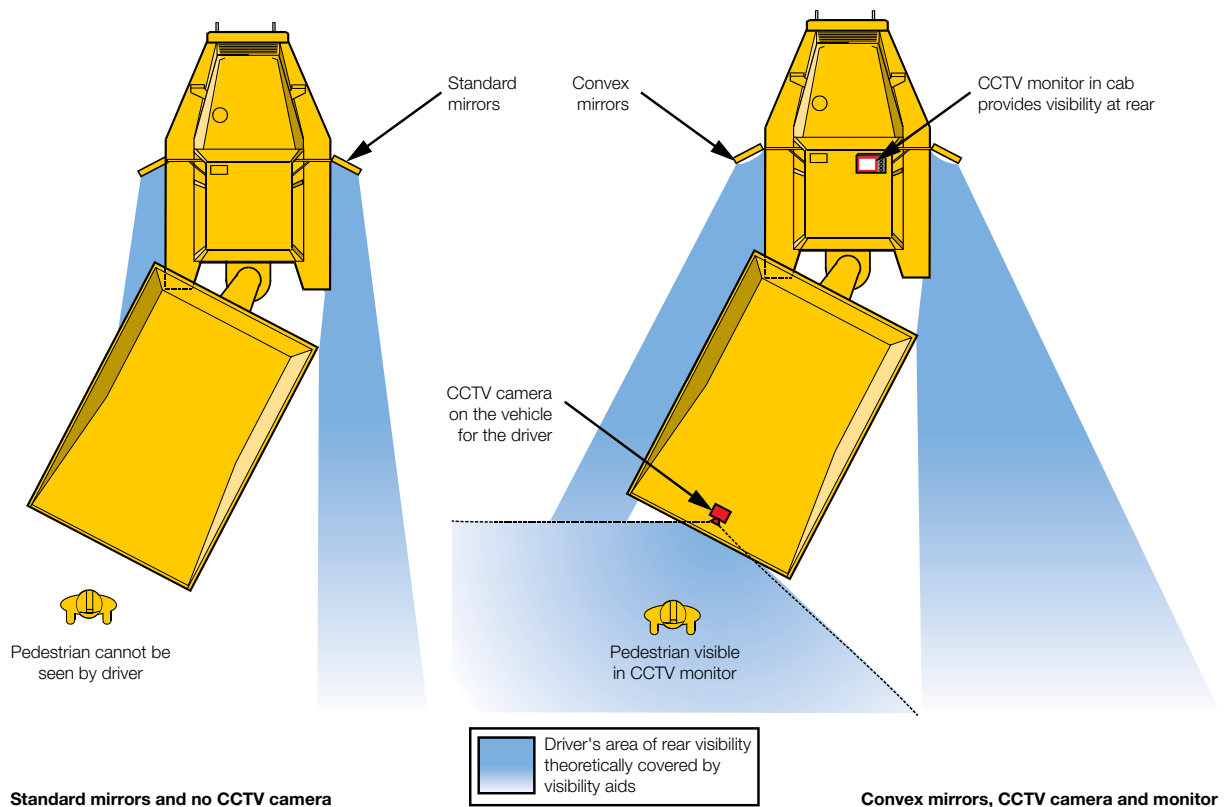

**Figure 37** Some vehicles are fitted with vision aids such as mirrors or CCTV, which help drivers to see areas that they cannot view directly

287 If there are blind spots remaining around a machine, decide whether any further action is required. Consider:

- what blind spots remain (including any created by typical loads);
- the ways in which the machine can move and the position of any danger zones caused by those movements; and
- whether pedestrians, vulnerable structures, and anything that might cause the vehicle to overturn are effectively prevented from being in any danger zone that the driver cannot see.

288 If further action to control the risks is necessary, review the site layout and management arrangements for avoiding such risks. If the risk cannot be removed by site changes, consider fitting additional vision aids or using a properly trained signaller to assist the driver.

289 Make sure drivers are aware of the areas of limited visibility. Warn other workers as part of their induction.

290 Keep cab windows and any vision aids clean.

### **Inspection and maintenance**

291 Construction vehicles work in harsh environments and require effective maintenance. A programme of daily visual checks, regular inspections and servicing schedules should be established according to the manufacturer's instructions and the risks associated with the use of each vehicle.

292 Plant hire companies should provide information with all plant and equipment they supply, to enable it to be used and maintained safely. Vehicles should have a maintenance log to help manage and record maintenance operations.

293 Drivers should be encouraged to report defects or problems. Reported problems should be put right quickly and if they are safety critical, the machine should be taken out of use until they are repaired.

294 Planned inspection and maintenance needs to follow the manufacturer's guidelines and is likely to include, where appropriate:

- braking systems, including the handbrake;
- seat belts;
- tyres, including condition and pressures;
- steering;
- windows, windscreen washers and wipers;
- mirrors, CCTV, and other vision aids (Figure 37);
- safety devices such as interlocks or isolation devices;
- warning signals;
- driver protection, eg roll over protective structures (ROPS) and falling object protective structures (FOPS);
- lights and indicators;
- functional checks on controls;
- correct location of guards and panels;
- fire-fighting equipment.

## **Training and competence**

### **Drivers**

295 Many accidents are the result of untrained or inexperienced workers driving construction vehicles. The use of any site plant or vehicle should be restricted to competent drivers who have been authorised to operate that vehicle.

296 Help prevent any unauthorised use by:

- only allowing authorised drivers to hold vehicle keys. Drivers should not loan keys to other workers;
- instructing drivers to turn off a vehicle's engine and remove the key whenever they leave that vehicle;
- ensuring all vehicles are securely immobilised whenever the site is unoccupied.

297 Driver competence may be judged on the basis of experience, recognised training and testing of knowledge and ability. Certificates of training from recognised training schemes help demonstrate competence in operating a general class of plant or vehicle. Training certificates should be checked for validity and training records should be kept up to date.

298 Drivers should also be trained in the safe operation of the specific machines that they are required to drive. This may include:

- layout and operation of the controls;
- stability limits;
- limits on drivers' vision and the use of any vision aids;
- daily checks, and how to do them safely.

299 No-one unfit to drive through the influence of alcohol, drugs or medication should be permitted to drive any vehicle.

300 Consider providing a daily briefing to drivers to update them on any problems with traffic routes or areas where other activities might cause difficulties.

### Signallers

301 Signallers used to direct vehicle movements need to be competent to undertake the task safely. They are often the person closest to a moving vehicle and therefore they can be at significant risk of being struck by that vehicle unless they and the driver work safely. No one other than trained and authorised signallers should attempt to direct vehicle movements

302 Wherever possible provide signallers with a protected position from which they can work in safety. Signallers should be easily distinguished on site, eg by providing them with distinctive clothing.

303 Drivers under the control of a signaller should be instructed that if they cannot see the signaller they should stop immediately.

304 A checklist for signallers' safe working practices can be found in Safe use of vehicles on construction sites.<sup>3</sup>

### Workforce

305 It is likely that every worker on site will need to travel on foot. As part of the general induction, all workers should be instructed in the safe pedestrian routes on the site, and in any site rules controlling pedestrians.

306 It is also likely that many workers will, at some time, need to approach a working machine. They should be instructed in a safe procedure for making the driver aware of their intention to approach, and ensuring that the machine is safely at rest before they approach.

307 Do not let anyone ride on vehicles or mobile plant except where the vehicle has been designed to carry a passenger.

## Moving goods safely

308 Many construction workers are killed or seriously injured during lifting operations because of accidents such as:

- cranes overturning;
- material falling from hoists; and
- slinging failures.

309 Many more suffer long-term injury because they regularly lift or carry items that are heavy or awkward to handle, eg:

- block layers lifting dense concrete blocks;
- pavers laying slabs; and
- labourers lifting and carrying bagged products, such as cement and aggregates.

310 To avoid the risk of injury it is essential that all material handling is properly planned. Where possible, avoid people having to lift materials at all. Where lifting is unavoidable provide mechanical handling aids wherever possible. Make sure that all equipment used for lifting is in good condition and is used by trained and competent workers.

311 Plan for material handling:

- before the job starts, decide what sort of material handling is going to take place and what equipment will be needed;
- avoid double handling – it increases risks and is inefficient;
- make sure that any equipment is delivered to the site in good time and that the site has been prepared for it. Materials and products should, where possible, be delivered in a form that can easily be moved around the site with minimal manual handling, eg palletised loads that can be moved by fork-lift truck;
- ensure the equipment is set up and operated only by trained and experienced workers;
- co-ordinate site activities so that those involved in lifting operations do not endanger other workers and vice versa;
- do not stand under loads being lifted;
- arrange for the equipment to be regularly inspected and thoroughly examined at relevant time periods by a competent person. Make sure reports of thorough examinations and records of inspections are kept. The Lifting Operations and Lifting Equipment Regulations 1998<sup>10</sup> (see paragraph 651) give details of what has to be documented.

### Manual handling

312 Lifting and moving loads manually is one of the most common causes of injury at work. Many manual handling injuries result from repeated operations, but even one bad lift can cause a lifetime of pain and disability. The Manual Handling Operations Regulations 1992<sup>11</sup> require employers to **avoid** the need to carry out manual handling which creates a risk of injury. Where avoidance is not reasonably practicable, employers have to make an assessment, reduce the risk of injury as far as reasonably practicable and provide information about the weight of loads.

313 There is no truly 'safe' weight limit for manual handling operations. The degree of risk associated with lifting varies according to the nature of the load, the circumstances in which the lift takes place, how often the lifting operation is carried out and the weight of the item that is being lifted.

314 When manual handling is necessary, prevent injury by:

- avoiding unnecessary handling;
- before work starts, identify operations which involve either lifting heavy or awkward loads or repetitive lifting operations. It is essential to find out the weight of heavy items which may have to be manually handled. Find ways of either:
  - avoiding the operation altogether; or
  - using lightweight materials, eg lightweight kerbs are available, which weigh less than 10 kg; or
  - using mechanical aids, such as vacuum lifters or grabs for kerbs and paving (see Figure 38);
- positioning loads by machine and planning to reduce the height from which they have to be lifted and the distance over which they have to be carried;
- setting limits on the size of commonly used products or material, eg not requiring anyone to manually lift building blocks, kerbs or paving weighing more than 20 kg;
- ordering bagged materials in small, easily handled sizes where possible; most building products are now available in 25 kg bags. Plan difficult manual lifts carefully, particularly if the load is to be shared. Remember, hazards arise when people are not equally matched in terms of size and strength and if they have not been trained to undertake multiple person lifts;
- training workers in safe lifting techniques and sensible handling of loads.



**Figure 38** Handling kerbs using a vacuum lifter

315 Manual handling injuries occurring at work may need to be reported to HSE under the Reporting of Injuries, Diseases and Dangerous Occurrences Regulations 1995<sup>7</sup> (see paragraphs 668-673) and anyone injuring their back at work should get early medical attention and return only gradually to handling duties.

### Gin wheels

316 Gin wheels provide a convenient way of raising tools and light loads manually. Though simple pieces of equipment, care is needed when assembling and using them if accidents are to be avoided. If a gin wheel or similar is to be used, make sure it has:

- been securely fixed to a secure anchorage, to prevent displacement;
- a proper hook designed to prevent load displacement or a hook fitted with a safety catch. The safety catch will retain the load in case it snags. Do not use bent reinforcing rods or other makeshift hooks;
- a safe working platform from which the hook can be loaded and unloaded; and
- been clearly marked with a working load limit.



## Hoists

317 Hoists of various types are widely used on construction sites and include goods and passenger hoists, inclined hoists and transport platforms. They have become an essential part of almost any construction project providing the facility for the smooth and rapid movement of workers and materials.

318 Hoists must be:

- properly constructed of sound materials and capable of lifting the required loads;
- properly marked as to use either for equipment and materials only, or for passengers in addition to goods, and the number that can be carried, together with a safe working load notice. Never allow passengers to ride on a goods-only hoist;
- erected only by trained and experienced people following the manufacturer's instructions and properly secured to the supporting structure;
- operated only by trained and competent people;
- thoroughly examined and tested after erection, substantial alteration or repair and at relevant intervals. Regular checks should be carried out and the results recorded. As a general guide, weekly checks should suffice.

319 Set the controls up:

- so that the hoist can be operated from one position only, eg ground level; and
- the operator can see all the landing levels from the operating position.

320 To prevent people being struck by the platform or other moving parts:

- enclose the hoistway at places where people might be struck, eg working platforms or window openings; and
- provide gates at all landings and at ground level.

321 Prevent people falling down the hoistway by making sure:

- the hoistway is fenced where people could fall down it;
- the gates at landings are kept closed except during loading and unloading. Gates should be secure and not free to swing into the hoistway; and
- the edge of the hoist platform is close to the edge of the landing so that there is no gap to fall through.

322 Prevent people being hit by falling materials by:

- stopping loads falling from the platform, eg make sure wheelbarrows are securely chocked and are not overfilled and that loads are evenly distributed on the hoist platform;
- not carrying loose loads such as bricks. Put loose loads in proper containers or use a hoist with an enclosed platform;
- not overloading the platform. It should be clearly marked with its working load limit; and
- enclosing the hoistway.

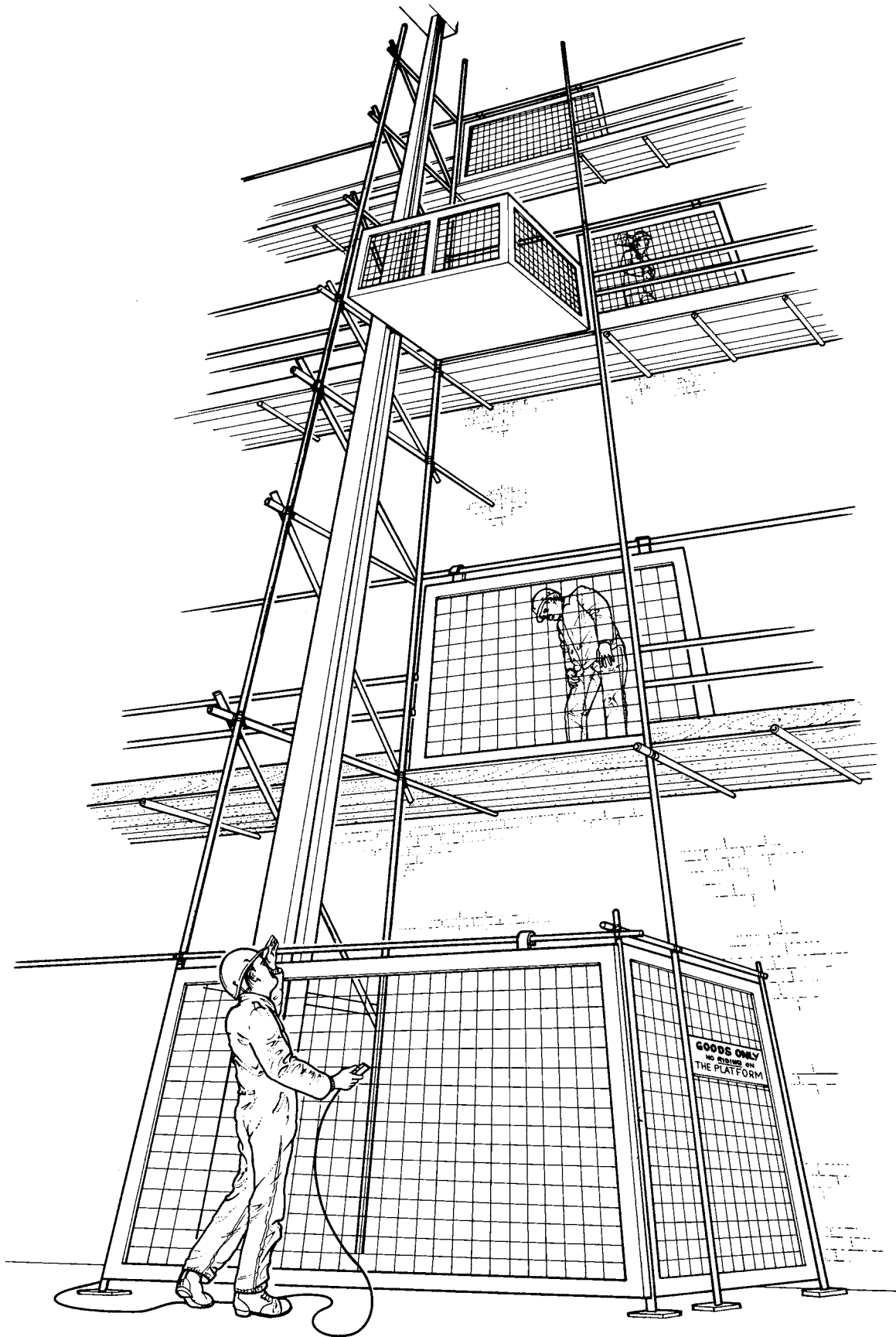

**Figure 39** The operator of this hoist has a clear view of each landing. The base of the hoist is protected by a cage and each landing is protected by a sliding gate

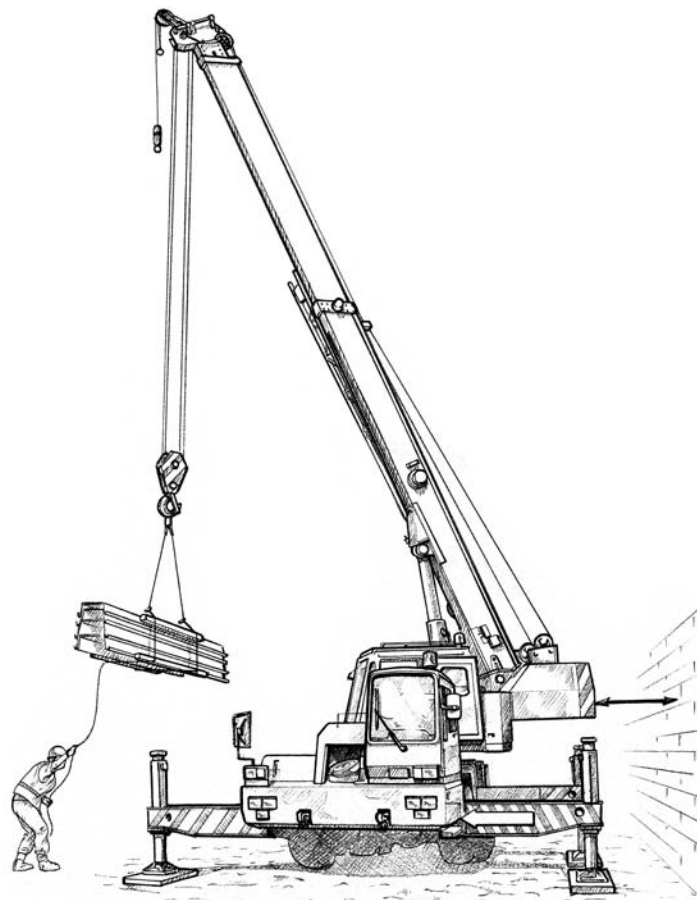

**Figure 40** A mobile crane is supported on outriggers which are prevented from sinking into the ground by timber packing. The crane is positioned to ensure adequate clearance between the wall and the counterweight. The slings are protected by packing around the load. The load is fitted with a tag line to allow it to be easily controlled

### Mobile cranes

323 All construction jobs are likely to involve lifting operations, even if it is only the use of a lorry loader to deliver materials to site. Lifting operations can be hazardous activities if they are not properly planned and carried out safely.

324 The term 'mobile crane' includes any crane capable of travelling under its own power. Mobile cranes provide a versatile, reliable means of lifting on site. However, it is easy to become complacent about their safe use and complacency can lead to serious accidents.

325 Safe lifting depends on three key elements, which require that the operation must be:

- properly planned by a competent person (also known as the 'appointed person');
- appropriately supervised (by a competent 'crane supervisor'); and
- carried out in a safe manner.

326 No lift is small enough to be left to chance. Every lift should be planned and carried out by trained, competent people. If no one has the expertise, contract out the work to someone who does. If a lift is going to be carried out, accidents can be avoided by appointing someone (not the crane operator) with the expertise to take charge and control the lifting operation.

### **Planning and preparation**

327 The degree of planning and preparation will depend upon the complexity of the lifting operation to be undertaken. The first step in any operation should be to identify the risks involved by carrying out a risk assessment. The next step is to draw up a plan to show how the risks will be eliminated or controlled. Only the appointed person should plan the lifting operation. The appointed person must be competent in planning lifting operations as well as possessing adequate practical and theoretical knowledge and experience of lifting operations. The outcome of the planning process should be a comprehensive and clear method statement or lift plan.

328 Planning for a safe lifting operation will include:

- selecting the right crane for the job. It will need to be:
  - able to lift the heaviest load at the required radius with capacity to spare.  
The maximum load a crane can lift decreases the further the load is from the crane, so a crane rated at 20 tonnes may be needed to lift a one tonne load;
  - able to get on and off the site, be assembled if required and operate within the confines of the site;
- positioning the crane in a safe place, so that:
  - the crane operator has a clear view;
  - it is well away from overhead power lines, excavations and railway lines;
  - it is on level ground that can take its full weight and its load (timber packing may be needed). Check there are no voids such as drains or basements which could collapse suddenly and that ground conditions have not been affected by the weather;
- making sure a rated capacity indicator (automatic safe load indicator) is fitted (when the crane is able to lift more than one tonne) and is in good working order;
- selecting the most suitable lifting accessories (eg chains, slings, wire rope, hooks, spreader beams etc) and method of slinging (choker sling, double wrap, cradle sling etc) relative to the weight, shape, centre of gravity, lifting points and load stability;
- checking that the crane and any lifting accessories have a current thorough examination report;
- making sure the crane supervisor, crane operator, slinger and signaller are trained and experienced by asking for evidence to be produced.

### **Supervising the lift**

329 Every lifting operation must be appropriately supervised to ensure that the lift plan is distributed, understood and followed and that the work is being carried out safely. The supervision required should be proportionate to the risk and the level of experience of the personnel involved. The supervisor should be someone other than the crane operator.

330 Supervisors should have received sufficient training and be competent to supervise the operation. A supervisor should:

- direct and supervise the work;
- be fully briefed on the safe system of work described in the lift plan;
- be able to identify any problems either arising from changed site conditions or occurring while the lifting operation is in progress and have the authority to stop the operation until guidance can be provided by the person who planned the lift; and
- be capable of giving clear, unambiguous instructions to all the members of the team.
-

### Carrying out the lift

331 Lifting operations should be carried out following the lift plan under the supervision of a competent person, who controls the team (crane operator, slinger, signaller etc) and who can stop the lift at any time should they consider the lift to be unsafe.

332 When carrying out any lift make sure:

- all those involved in the lift know their role and understand who is in control of the operation;
- load routes are established to avoid loads being lifted over people;
- the load is properly slung by a competent person. Ensure the chains and slings are of the correct strength and are in good condition. Chains and slings may be damaged by the load, so packing could be necessary. The centre of gravity of the load may not be in the middle of the load (this is very common with pieces of plant), causing it to shift or slip out of its slings when it is raised. It is important that loads are slung so that they are in balance with their centre of gravity beneath the hook (see Figure 41);
- a competent banksman or signaller is provided if the driver's view is restricted;
- there is adequate clearance so that people are not struck or trapped by the load, counterweight or body of the crane. If traps are unavoidable, fence them off;
- where necessary, tag lines are used to guide loads, eg in windy conditions or on large loads;
- if the site team cannot complete the lift as planned, the appointed person must be consulted before the plan is changed.

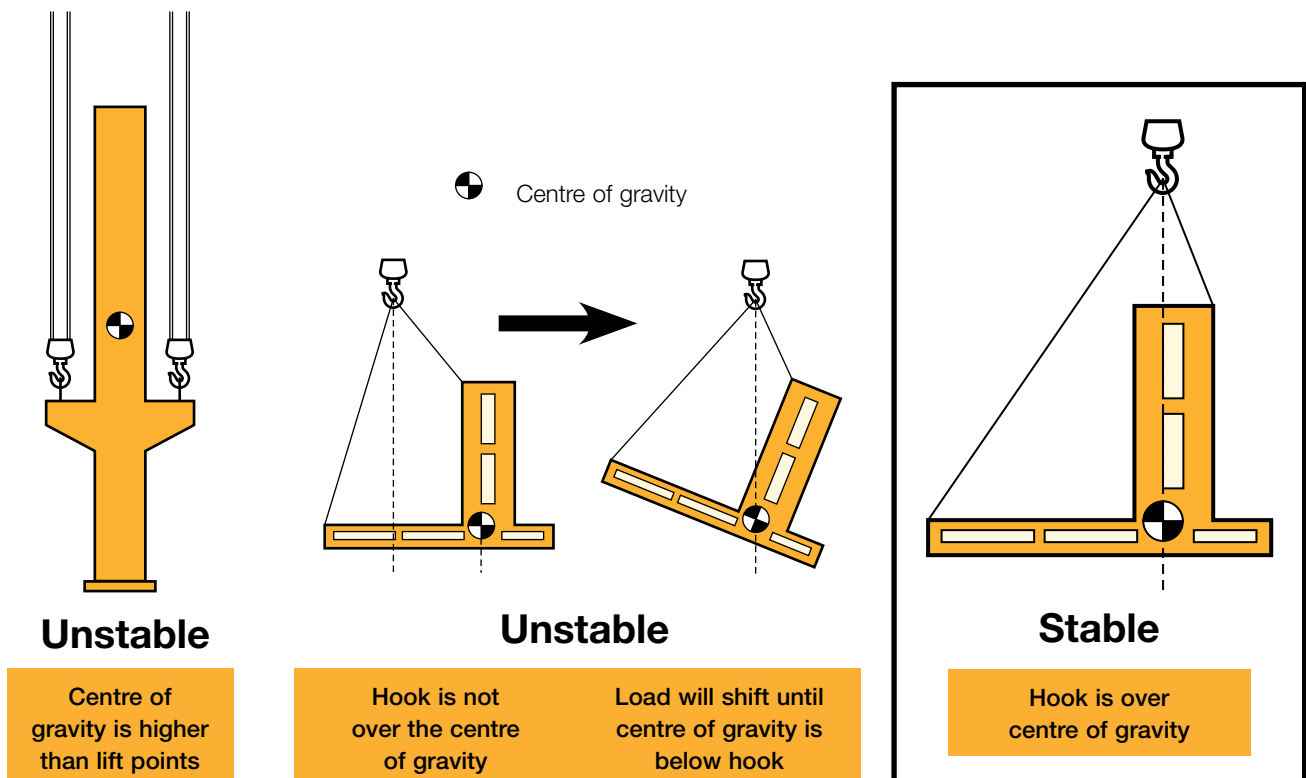

Figure 41 The centre of gravity must be beneath the hook

### Crane hire and contract lifts

333 The main difference between crane hire and a contract lift is who takes the responsibility for the three key elements in paragraph 325. In other words, who will plan, supervise and be responsible for the lifting operation.

334 With a contract lift, the crane hire company will plan and supervise the lifting operation and will be responsible for ensuring it is carried out in a safe manner.

335 With crane hire, the crane operator works to your instructions and you are responsible for writing the lift plan, supervising the lift and ensuring it is carried out in a safe manner. Before selecting crane hire, ask yourself the following questions:

- Will the lift be properly planned by a competent appointed person, and what are their credentials?
- Who will supervise the lifting operation for you? (This will be a competent person provided by you and will not be undertaken by the crane operator.)
- Have you carried out a risk assessment and prepared a written plan containing the information in paragraph 328 and any other relevant information?
- Can you confirm that the lift plan will be discussed with the crane driver before the lifting operation commences?

336 If you are unsure of what is required then you should speak to the crane hire company about a contract lift.

337 For further information see *Safe use of lifting equipment. Lifting Operations and Lifting Equipment Regulations 1998. Approved Code of Practice and guidance.*<sup>12</sup>

## Groundwork

338 Almost all construction work involves some form of excavation (for foundations, drains, sewers etc) and every year people are killed or seriously injured while working in excavations. Many are killed or injured by collapses and falling materials, others are killed or injured when they contact underground or overhead services.

339 Designers and those specifying work should always consider the use of trenchless techniques, such as micro-tunneling, directional drilling, impact moling and pipe bursting etc, which replace the need for excavation, apart from the launch and reception pits. They also reduce risks to members of the public from open excavations and subsequent traffic disruption. It is crucial to survey any obstructions and control the machine cutting head to avoid them. Service location plans and location devices should be used to ensure that that route of the bored service does not impinge on existing services.

340 However, if excavations are required, the work must be properly planned and carried out to prevent accidents. There is almost no ground that can be relied upon to stand unsupported in all circumstances and the risk is self-evident when you consider that it is quite common for one cubic metre of soil to collapse into an unsupported excavation, and this can weigh as much as one tonne.

## Excavations

341 Before digging any trenches, pits, tunnels, or other excavations, decide what temporary support will be required and plan the precautions that are going to be taken against:

- collapse of the sides;
- people and vehicles falling into the excavation;
- materials falling onto people working in the excavation;
- undermining nearby structures;
- underground and overhead services; and
- the inflow of ground and surface water.

342 Make sure the equipment and precautions needed (such as trench sheets, props, baulks etc) are available on site before work starts. If information such as results of soil tests or trial holes is available, it may provide useful data on conditions likely to be found on site, which can assist planning. Put the precautions into practice.

### *Collapse of the sides or roof*

343 The need for adequate support will depend on the type of excavation, the nature of the ground and the ground water conditions.

344 Prevent the sides from collapsing by supporting them with sheeting or proprietary support systems (see Figure 42). Take similar precautions to prevent the face from collapsing. Install support without delay as the excavation progresses. Never work ahead of the support or remove it prematurely. The work should be directed by a competent supervisor. Give the workers clear instructions.

345 Any unsupported excavation will be safe without support **ONLY** if its sides are battered back sufficiently, or if the excavation is in sound rock. Battering back the sides of an excavation to a safe angle is a simple and acceptable means of preventing instability. In granular soils the angle of slope should be less than the natural angle of repose of the material being excavated. In wet ground a considerably flatter slope will be required.

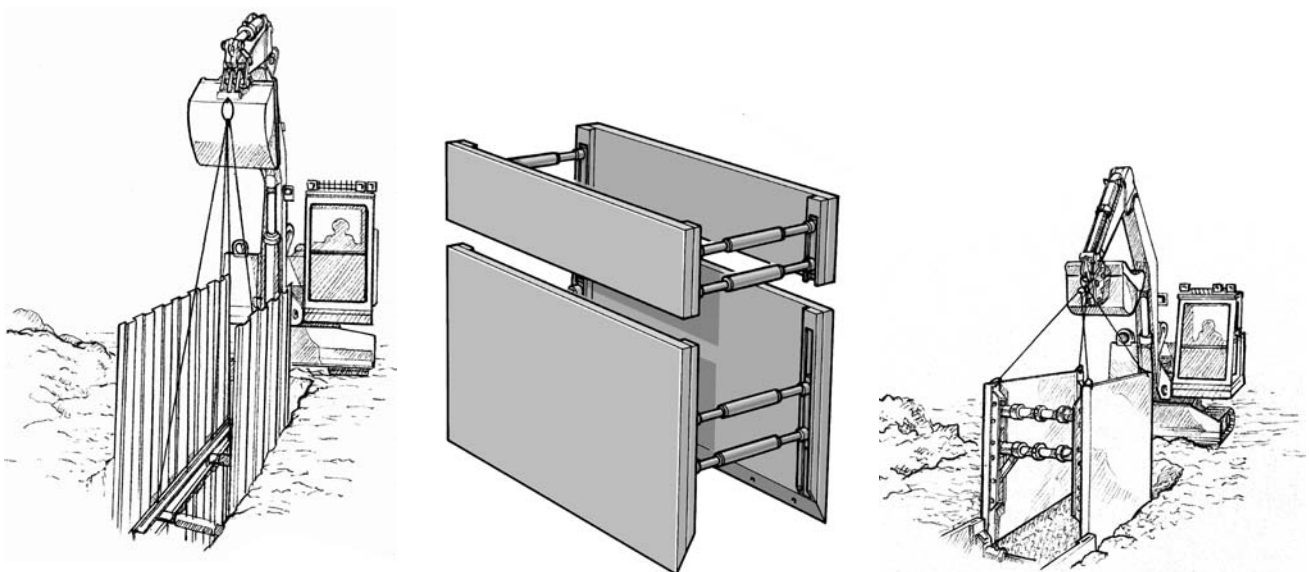
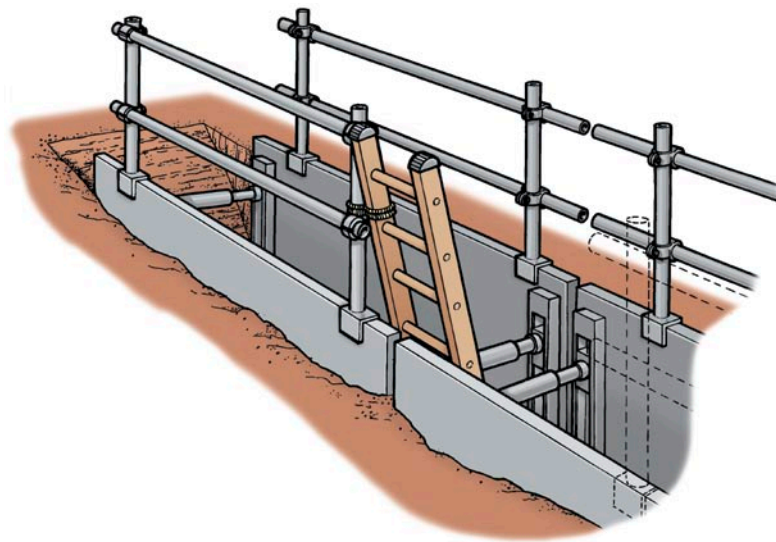

**Figure 42** Proprietary trench boxes and hydraulic wallings allow trench supports to be put in place without requiring people to enter the excavation

346 A competent person who fully understands the dangers and necessary precautions should inspect the excavation at the start of each shift. Excavations should also be inspected after any event that may have affected their strength or stability, or after a fall of rock or earth. A record of the inspections will be required (see paragraphs 358-365). Immediately put right any faults that are found.

**People and vehicles falling into excavations**

347 Prevent people from falling by guarding excavations. Edges of excavations should be protected with substantial barriers where people are liable to fall into them. This can be achieved using guard rails and toe boards, which can be inserted into the ground immediately next to the supported excavation side, or using fabricated guard rail assemblies that connect onto the sides of the trench box (see Figure 43). Alternatively, make use of the support system itself, eg using trench box extensions or trench sheets longer than the trench depth (see Figure 44). All excavations in public places should be suitably fenced off to prevent members of the public approaching them.



**Figure 43** A trench box with guard rails attached

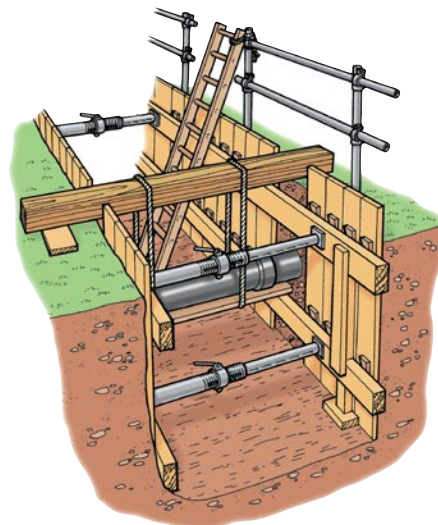

**Figure 44** An excavation supported by timbering and props with guard rails (omitted from left-hand side for clarity) to prevent falls. Extended poling boards act as toe boards, safe access is provided by a tied ladder and exposed services are supported



348 Prevent vehicles from falling into excavations by keeping them out of the area. Vehicles passing close to the edges of excavations may also overload the sides, leading to collapse. Where necessary, use baulks or barriers to keep vehicles away from excavated edges. Baulks and barriers are best painted or marked to make sure they can be seen by drivers.

349 Where vehicles have to tip materials into excavations, prevent them from overrunning into the excavation by using properly secured stop-blocks. These must be placed at a sufficient distance from the edge of the excavation to avoid the danger of the edge breaking away under the weight of the vehicle. The sides of the excavation may also require extra support.

#### ***Materials falling into excavations***

350 Do not park plant and vehicles or store excavated spoil and other materials close to the sides of excavations. The extra loadings from spoil, vehicles etc can make the sides of excavations more likely to collapse. Loose materials may fall from spoil heaps into the excavation. Edge protection should include toeboards or other means, such as projecting trench sheets or box sides to protect against falling materials. Head protection should be worn.

#### ***Undermining nearby structures***

351 Make sure excavations do not undermine the scaffold footings, buried services or the foundations of nearby buildings or walls. Many garden or boundary walls have very shallow foundations which are easily undermined by even small trenches, causing the wall to collapse onto those working in the trench. Before digging starts, decide if extra support for the structure is needed. Surveys of the foundations and the advice of a structural engineer may be required.

#### ***Underground and overhead services***

352 Many serious accidents have occurred when buried services have been damaged during excavation work. In particular, contact with any electricity cables can result in explosion and burns to those in the vicinity. Escaping gas which ignites can cause serious injury and/or property damage as a result of fire and explosion. Excavation work should not start until steps have been taken to identify and prevent any risk of injury arising from underground services (see paragraphs 366-381).

353 Burns and electrocution can result if raised tipper truck bodies or excavators touch or come close enough to overhead power lines to cause arcing. There is a risk to all those close to the item of plant which becomes live, as well as to the operator. The need to undertake excavation work close to or below such lines should be very carefully considered and avoided where possible. See paragraphs 493-500 for the precautions that must be taken when carrying out work close to overhead power lines.

#### ***Ground and surface water inflow***

354 Depending on the permeability of the ground, water may flow into any excavation below the natural groundwater level. The supports to the side of the excavation should be designed to control the entry of groundwater and the design should take any additional water loading into account. Particular attention should be given to areas close to lakes, rivers and the sea.

355 Water entering the excavation needs to be channelled to sumps from where it can be pumped out; however, the effect of pumping from sumps on the stability of the excavation should be considered. Alternative techniques for de-watering (such as ground freezing and grout injection) could also be used. Designers will need to consider these issues.

***Other aspects of excavation safety***

356 Provide a safe means of getting into and out of an excavation. If a risk assessment identifies that ladders are a reasonable means of access and egress from an excavation, they must be suitable and of sufficient strength for the purpose. They must be on a firm level base, secured to prevent slipping and, unless a suitable alternative handhold is provided, extend to a height of at least 1 m above the landing place.

357 Consider hazardous fumes – do not use petrol or diesel engines in excavations without making arrangements for the fumes to be ducted safely away, or providing for forced ventilation. Do not site petrol or diesel-engined equipment (such as generators or compressors) in or near the edge of an excavation; exhaust gases can collect and accumulate. For information about fumes in confined spaces, including excavations, see paragraphs 505-515.

***Inspections and reports***

358 Excavations that need to be supported or battered back to prevent danger must be inspected. The person in control of the excavation must arrange for a competent person to carry out these inspections:

- at the start of the shift before work begins;
- after any event likely to have affected its stability; and
- after any accidental fall of rock, earth or other material.

359 If the competent person is not satisfied that work can be carried out safely, they should advise the person the inspection was carried out for as soon as possible and the excavation should not be used until the defects have been put right.

360 A written report should be made following most inspections. The competent person must:

- complete the inspection report before the end of the working period; and
- within 24 hours, provide a copy of the report to the person for whom the inspection was carried out.

361 The person receiving the report must:

- keep it at the site where the inspection was carried out until construction work is completed; and
- thereafter, keep it at an office for three months.

362 For an excavation, only one written report is required within any seven-day period, unless there has been a collapse/fall of material or other event likely to affect stability. In this case an inspection and report are required before work starts again.

363 The report should contain the following information:

- name and address of the person the inspection was carried out for;
- location of the place of work or work equipment inspected;
- description of the place of work or work equipment inspected;
- date and time of the inspection;
- details of any matter identified that could give rise to a risk to the health or safety of any person;
- details of any action taken as a result of any matter identified in the point above;
- details of any further action considered necessary; and
- name and position of the person making the report.

364 Appendix 1 contains an inspection timing and frequency chart and a suggested format, which may be reproduced or copied for recording this information. The suggested form does not have to be used – any form containing the required information is acceptable. The reverse of the form summarises the requirements for timing and frequency of inspections.

365 For further information on excavation work read *Health and safety in excavations: Be safe and shore*.<sup>13</sup>

### **Underground services**

366 Many serious accidents have occurred when buried services have been damaged during excavation work. If the proper precautions are not taken, it is all too easy for workers to hit these services, resulting in risks to themselves and others in the vicinity. In addition, the interruption of services can create serious problems for consumers, especially those critically dependent upon them, eg a hospital.

367 The most obvious examples of buried services are those used to carry electricity, gas, water and telecommunications.

368 A significant risk of injury results from accidental contact with electricity cables. Buried electrical cables often carry high voltages and accidental contact has resulted in deaths and major burns. Most injuries are caused to people using pneumatic drills and involve 415-volt cables within 0.5 m of the surface.

369 When a gas pipe is damaged, escaping gas that ignites can cause serious injury and/or property damage as a result of fire and explosion. Serious accidents have arisen where gas from damaged pipes has tracked back underground into buildings where it has subsequently ignited.

370 The consequences of damaging water pipes and telephone cables may be less immediately evident, but are nonetheless serious, both in terms of disruption and cost. Fibre optic telecommunication cables are very expensive and a simple break may mean a costly repair.

371 Before work starts, check with all public and private utilities (such as electricity, gas, water, telecommunication and cable TV companies) and the landowner for the existence of services, and obtain service plans.

372 Service plans should not be considered as completely accurate and serve only to indicate the likely presence of services. Use them as a guide to see whether the place intended for digging may involve working near buried underground services. Look out for signs of services such as manholes, valve covers, street lights etc.

373 It is essential that service-locating devices (also known as CATs, which stands for cable avoidance tools) are used by properly trained people to identify, as far as possible, the actual location of the underground services. When looking at service plans, remember that reference points and services may have been moved and that not all service connections or private services are shown.

374 The line of any identified services should be recorded and the route marked with paint on paved surfaces (use biodegradable paint or erase residual markings as soon as possible after excavation) or with wooden pegs in grassed or unsurfaced areas. Do not use steel spikes which can damage services laid at a shallow depth.

375 Once the approximate location of a service has been identified, trial holes

should be dug carefully by hand to establish the exact location and depth of the service. Where two holes are dug at intervals, it should not be assumed that the service runs in a straight line between them.

376 Hand tools can be a common source of accidents if used incorrectly. However, when used carefully, they can normally provide a satisfactory way of exposing buried services, once the approximate positions have been determined. Every effort should be made to excavate alongside the service rather than directly above it. Final exposure of the service by horizontal digging is recommended as the force applied to hand tools can be controlled more effectively.

377 Mechanical excavators and power tools should not be used within 0.5 m of the indicated line of a service. Power tools may be used to break paved surfaces but great care must be taken to avoid over-penetration, as a service may have been laid at an unusually shallow depth. Power tools must never be used directly over the indicated line of a cable unless it has been made dead.

378 Before digging, make sure that:

- all workers involved in the digging know about safe digging practice and emergency procedures and that they are properly supervised;
- the locator, guided by the service plans, is used to trace as accurately as possible the actual line of any pipe or cable or to confirm that there are no pipes or cables in the way, and the ground has been marked accordingly;
- there is an emergency plan to deal with damage to cables or pipes. Have a system for notifying the service owner in all circumstances. In the case of gas pipe damage, ban smoking and naked flames. Carry out evacuation whenever necessary (this may include people in nearby properties likely to be affected by leaks). Erect suitable signs to warn everyone of the danger.

379 Excavate using safe digging practices:

- keep a careful watch for evidence of pipes or cables during digging and repeat checks with the locator. If unidentified services are found, stop work until further checks can be made to confirm it is safe to proceed;
- hand dig trial holes to confirm the position of the pipes or cables. This is particularly important in the case of plastic pipes, which cannot be detected by normal locating equipment;
- hand dig near buried pipes or cables or use air-powered excavation devices. Use spades and shovels rather than picks and forks, which are more likely to pierce cables;
- do not use handheld power tools within 0.5 m of the indicated position of an electricity cable;
- do not use an excavator to excavate within 0.5 m of a gas pipe;
- treat all pipes or cables as 'live' unless it is known otherwise. What looks like a rusty pipe may be conduit containing a live cable. Do not break or cut into any service until its identity is certain and it is known that it has been made safe;
- support services once they are exposed to prevent them from being damaged, and make sure that they are not used as hand or footholds when people are getting in and out of the trench;
- report any suspected damage to services;
- backfill around pipes or cables with fine material. Backfill which is properly compacted, particularly under cast or rigid pipes, prevents settlement which could cause damage at a later date;
- once new services have been laid, update the plans.

380 The flow diagram in Figure 45 will help you understand the process, from referring to plans on site through to the start of the excavation. However, it describes only part of the process; it does not, for example, describe planning the work including reference to plans at the design stage and is not a substitute for a suitable and sufficient risk assessment.

381 For further information on avoiding danger from underground services see *Avoiding danger from underground services*.<sup>14</sup>

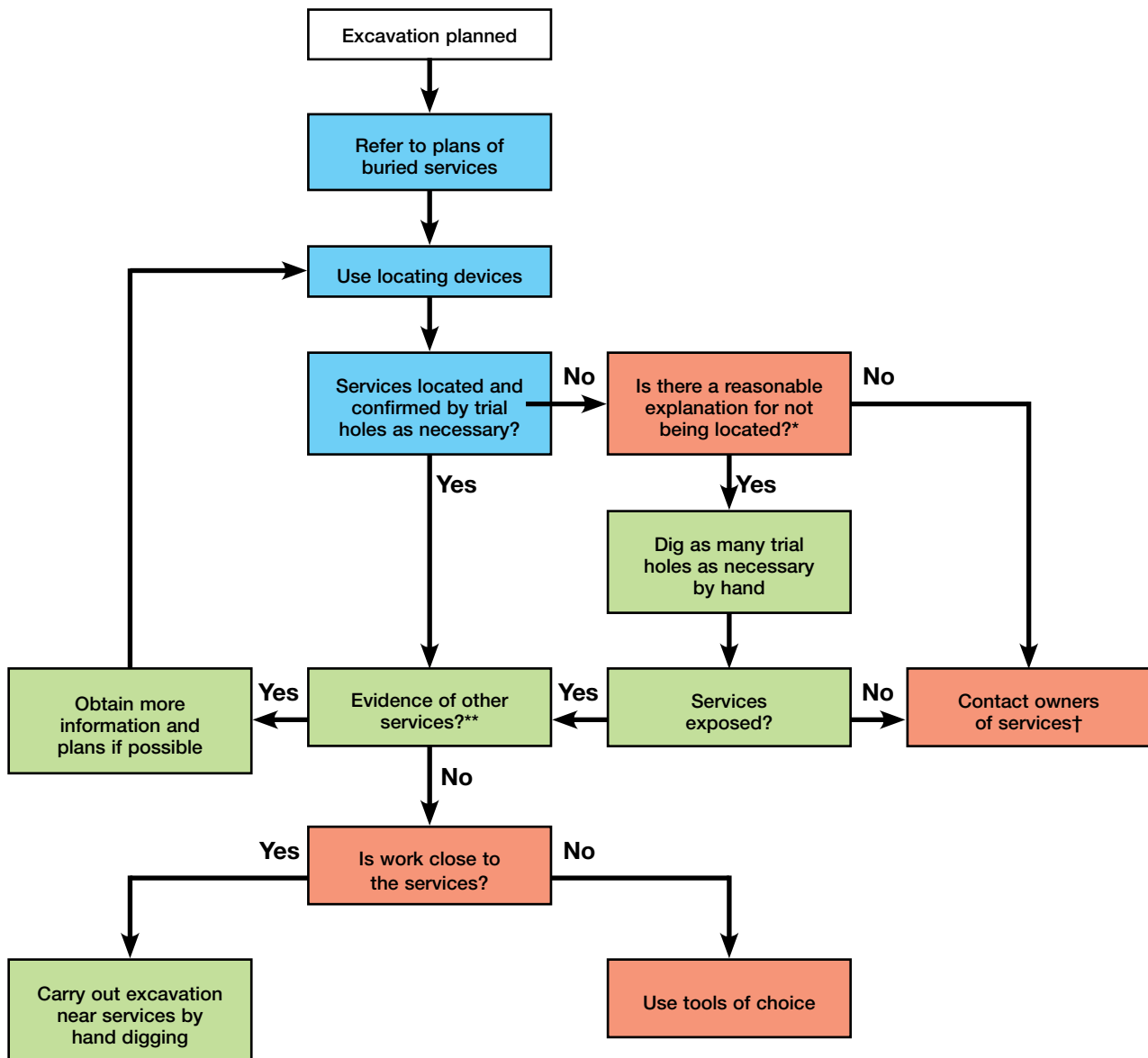

\* For example, could services be non-metallic pipes? Please refer to text for further information.

\*\* In particular, visual evidence. Ensure that the presence of services, which may be unmarked on plans or for which no plans are available, has been considered, eg service connections.

† If there is visual evidence of services, but owners cannot be traced, despite all reasonable attempts to do so, any excavation could proceed but using hand-dug trial holes and proceeding with great care.

Figure 45 Excavation planning process

# Demolition, dismantling and structural alteration

382 Demolition, dismantling and structural alteration are high-risk activities whose safe execution is complex and technical and where expertise is vital. They require careful planning and execution by contractors who are competent in the full range of demolition techniques.

383 During demolition and dismantling, workers are injured in falls from edges and through openings and fragile surfaces. Workers and passers-by can be injured by the premature and uncontrolled collapse of structures or parts of structures and by flying debris. Effective traffic management systems are essential to avoid workers being put at risk of being hit by slewing or reversing plant. Dust, noise and vibration are also significant problems that need to be considered and controlled when planning any demolition work.

384 The **CDM Regulations** apply to all demolition and **dismantling work** (see paragraphs 605-643/Figure 54). However, a project is only notifiable to HSE if it will last longer than 30 days or involve more than 500 person-days of work (paragraphs 34-37, Figure 1).

385 A systematic approach to the demolition process starts with responsible clients who have a legal obligation to appoint adequately resourced and competent duty holders such as structural engineers, planning supervisors and principal contractors. It is vital that clients also fulfill their legal obligation to provide information about the structure to be demolished and this often means commissioning a pre-demolition structural survey from a structural engineer.

386 The expertise of a structural engineer must be used in the following cases:

- in the design of a façade retention scheme;
- where there is doubt over the building's stability;
- where there is doubt about the proposed method of demolition;
- where there is doubt about the capacity of the building to take loadings.

387 It is good practice to consult a structural engineer at the planning stage of demolition to avoid uncontrolled collapse.

388 The principal contractor, who may also be the demolition contractor, must be able to co-ordinate and manage the health and safety issues during the demolition works. References must be sought and pertinent questions asked by the client to establish the credibility of the demolition contractor, especially if it is intended to appoint the demolition contractor as the principal contractor for the demolition phase of the work. A genuine and competent contractor will supply the name of the client for whom their last contract was carried out. They can be asked for information about the size and scale of the works, whether any problems were encountered, how the contractor performed and whether they would use the contractor again.

389 The client should also determine:

- whether the contractor employs a safety advisor or uses the services of a safety consultant and whether they have experience in the requirements of demolition;
- how often the safety advisor will visit the site;
- whether they will be provided with a copy of the site visit report to enable them to monitor the health and safety performance of their preferred contractor;
- what the contractor's safety statistics are in respect of injuries, near misses and dangerous occurrences;
- whether they have been issued with any improvement or prohibition notices or been prosecuted (this information is available on the HSE website for limited companies, partnerships and sole traders); and
- whether it is their intention to use subcontractors and if so, for what elements of the job and how will the subcontractor be selected and managed.

390 Ask the planning supervisor for their advice and input during the selection process.

391 The gathering and provision of information, careful planning and effective site management are essential elements for safe and successful demolition and structural alteration.

392 The key to developing a safe system of work is choosing a work method that keeps people as far away as possible from the risks. Proposed working methods may be best detailed in a health and safety method statement (see paragraph 592-597). Everyone involved in the work needs to know what precautions are to be taken. They should be supervised so that these precautions are put into practice.

393 It is essential that demolition is planned and carried out by trained demolition operatives under the supervision of a competent person. Supervisors should have knowledge of the particular type of demolition being carried out, its hazards and how to control them. In particular, they should understand and follow any demolition method statement and know of any particular demolition sequence required to avoid accidental collapse of the structure.

394 Before work starts, the site should be surveyed for hazardous material and structural condition. This is the responsibility of the client and must not be left for the demolition contractor to organise.

395 Consider the following:

- What is the age of the structure and what was its previous use?
- What was the type of construction (eg reinforced concrete frame or steel frame)? Are there any pre-stressed or post-stressed concrete beams present within the structure? Are floor slabs or piles involved? What materials are for reclamation and what precautions are required to carry out this work safely? This is particularly important during roof work when falls from height must be prevented.
- Can a method that keeps people away from the demolition be used, eg by using a high-reach machine? Machine cabs should be protected to safeguard drivers from falling materials.
- Will the demolition sequence make the structure itself or any nearby buildings or structures unstable? Is temporary propping required? What are the separation points? The advice of a structural engineer may be needed.
- Will the method of work require the floors to support the weight of removed material that may build up on them, or the weight of machines, eg skid-steer loaders used to clear the surcharge? Again, expert advice may be needed.
- Are there still any live services? Gas, electricity, water and telecommunication services need to be isolated or disconnected. Where such disconnection is not possible, pipes and cables should be clearly marked to ensure they are not disturbed during the work.
- Has all the asbestos in the building been identified, such as asbestos on pipe work, boilers and wall and ceiling panels (see paragraphs 432-448)? The client must ensure that an invasive (MDHS100<sup>15</sup> Type 3) asbestos survey has been carried out and evaluated, and that any asbestos identified has been removed before demolition or major structural alteration work starting.
- Is there any leftover contamination from previous use of the building, eg acids from industrial processes, lead paints, flammable liquids, unidentified drums? Have microbiological hazards in old hospitals or medical buildings been identified? Hazardous materials need to be removed and disposed of safely before demolition. The precautions needed for working with hazardous materials are set out in paragraphs 399-431.
- Will the proposed method minimise the need for operatives to use vibrating hand tools, which can cause hand-arm vibration syndrome (HAVS). The precautions necessary to avoid the risk of HAVS are set out in paragraphs 463-474.
- Can anyone who is not involved in the work be kept away by the provision of an exclusion zone around the work area? This should be clearly marked, where necessary, by barriers or hoardings. Do not allow materials to fall into any area where people are working or passing through. Fans or other protection such as covered walkways may be needed to provide protection where materials can fall. Keep operatives segregated from site plant to ensure people are not at risk from reversing vehicles or slewing excavators. Where possible, use vision aids and zero tail swing machines (see paragraphs 265-290).

396 Adequate toilets, washing facilities (including showers where necessary), rest facilities etc must be provided on site. Where there is more than one contractor on site, contractors may come to an agreement to share these facilities.

397 Fire is also a risk, especially where hot work is being carried out, so make sure the necessary precautions (see paragraphs 83-93) are in place. During structural alteration it is vital that the fire plan is kept up to date as the escape routes and fire points may alter, and that an effective means of raising the alarm in the event of a fire is available.



## Occupational health risks

398 Safety risks in construction have been recognised for some time. Occupational health risks have only recently started to be addressed. The main health risks in construction are:

- musculoskeletal disorders: back and other muscle and joint injuries (see *Moving, lifting and handling loads*);
- hand-arm vibration syndrome: pain and numbness in the fingers and hands caused by the use of vibrating tools (see paragraphs 463-474);
- dermatitis: redness and inflammation of the skin related to exposure to hazardous substances such as cements and solvents (see paragraphs 419-424);
- noise-induced hearing loss: deafness or ringing in the ears caused by exposure to high levels of noise;
- asbestos-related diseases (see paragraphs 432-448).

### Hazardous substances and processes

399 Any hazardous substances that are going to be used, or processes which may produce hazardous materials, should be identified. The risks from work that might affect site workers or members of the public should then be assessed. Designers should eliminate hazardous materials from their designs. Where this is not possible, they should specify the least hazardous products which perform satisfactorily.

400 Contractors often have detailed knowledge of alternative, less hazardous materials. Designers and contractors can often help each other in identifying hazardous materials and processes and suggesting less hazardous alternatives.

401 If workers use or are exposed to hazardous substances as a result of their work, the Control of Substances Hazardous to Health Regulations 2002<sup>16</sup> (COSHH) make it a legal duty to assess the health risks involved and to prevent exposure or else adequately control it. There are separate regulations for asbestos and lead – the Control of Asbestos at Work Regulations 2002<sup>17</sup> and the Control of Lead at Work Regulations 2002.<sup>18</sup>

### Identification

402 People may be exposed to hazardous substances either because they handle or use them directly (eg cement and solvents), or because the work itself results in the creation of a hazardous substance (eg scabbling concrete generates silica dust). Identify and assess both kinds of hazard.

403 If hazardous substances are going to be used, manufacturers and suppliers of such substances have a legal duty to provide information. Read the label on the container and/or the safety data sheet. Approach the manufacturer or supplier directly for more information if necessary.

404 Some hazardous substances may be on site before any work starts, eg sewer gases or ground contaminants. Assess these risks in the same way as for other hazardous substances. Information to help identify these risks may be available from the client, the design team or the principal contractor and should be contained in the pre-construction-stage health and safety plan.

### Assessment

405 Look at the way people are exposed to the hazardous substance in the particular job that they are about to do. Decide whether it is likely to harm anyone's health. Harm could be caused by:

- **Breathing in fumes, vapours, dust:** does the manufacturer's information say that there is a risk from inhaling the substance? Are large amounts of the substance being used? Is the work being done in a way that results in heavy air contamination, eg spray application? Is the work to be done in an area that is poorly ventilated, eg a basement? Does the work generate a hazard, eg hot cutting metal covered with lead causes lead fumes to be given off?
- **Direct contact with skin:** does the manufacturer's information say there is a risk from direct contact? How severe is it, eg are strong acids or alkalis being used? Does the method of work make skin contact likely, eg from splashes when pouring from one container to another, or from the method of application?
- **Swallowing or eating contaminated material:** some materials can contaminate the skin and hands. The contamination can then be passed to a person's mouth when they eat or smoke. This is a particular problem when handling lead and sanding lead-based paint. Make sure people do not smoke or eat without washing first.

406 Once a full assessment has been completed and where the same work is being done in the same way under similar circumstances at a number of sites, the risk assessment does not have to be repeated before every job but you should check it to make sure there are no real differences. You should continuously look out for new safer ways of working and new products, which could be safer substitutes.

407 If, however, there are many processes that result in different hazardous substances being used in a wide range of circumstances, a fresh assessment may be needed for each job or set of similar jobs. This will make sure the assessment is relevant to the job being done and the circumstances in which it is being carried out.

408 Remember to assess both immediate risks, eg being overcome by fumes in a confined space, and longer-term health risks. Materials like cement can cause dermatitis. Sensitising agents like isocyanates can make people using them have sudden reactions, even though they may have used the substance many times before.

### Prevention

409 If harm from the substance is possible, the first step to take is to try and avoid it completely by not using it at all. This will mean either:

- doing the job in a different way, eg instead of using acids or caustic soda to unblock a drain, use drain rods; or
- using a substitute substance, eg instead of using spirit-based paints, use water-based ones, which are generally less hazardous. However, always check one hazard is not simply being replaced by another.

### **Control**

410 If the substance has to be used because there is no alternative, or because use of the least hazardous alternative still leads to significant risk, the next step is to try and control exposure. Some of the ways this could be done include:

- transferring liquids with a pump or siphon (not one primed by mouth) rather than by hand. Keep containers closed except when transferring;
- rather than spraying solvent-based materials, use a roller with a splash guard or apply by brush;
- using as little of the hazardous substances as possible – don't take more to the workplace than is needed;
- using cutting and grinding tools and blasting equipment fitted with exhaust ventilation or water suppression to control dust;
- ensuring good ventilation in the working area by opening doors, windows and skylights. Mechanical ventilation equipment might be needed in some cases.

### **Personal protective equipment**

411 If, **and only if**, exposure cannot be adequately controlled by any combination of the measures already mentioned, you will need to provide personal protective equipment (PPE).

412 Any PPE must be selected with care. Choose good quality equipment which is CE-marked. Let the user of the equipment help choose it – they will be more willing to wear it. Explain to the user why the equipment has to be worn and the hazard(s) the equipment protects against.

### **Respiratory protection**

413 Respirators can protect against dusts, vapours and gases. There are many types of respiratory protective equipment (RPE), including:

- disposable face mask respirators;
- half-mask dust respirators;
- high-efficiency dust respirators;
- positive-pressure powered respirators;
- ventilator visor or helmet respirators;
- compressed air line breathing apparatus;
- self-contained breathing apparatus.

414 Make sure the respirator is the correct type for the job; dust masks may not protect against vapours or vice versa. If the respirator has replaceable cartridges, make sure the correct type is fitted, that they have not become exhausted or clogged and are still in date (many filters have a limited shelf life). Have replacement filters available.

415 A competent person should select RPE that is both suitable for the user and the job, as this choice will depend upon a number of factors, including:

- the nature of the hazards and materials;
- the measured level of the contaminant;
- the period of exposure;
- if working outdoors, the prevailing weather conditions;
- suitability for each user, such as field of vision, provision for communication and the ease of movement in cramped working places, eg confined spaces.

416 It is essential that respirators fit well around the face. Make sure the user knows how to wear the equipment and check for a good face seal. Respirators do not seal well against a beard, so when the user has a beard, alternative protection is needed, such as air-fed visors, which do not rely on a good face seal.

417 Users need to know how the respirator should be fitted and operated and what maintenance checks they should carry out. Supervise the user to make sure they are using the respirator properly and regularly checking it for damage.

418 Make sure the respirator does not become a source of contamination by keeping it clean. Store it in a clean box or cupboard – don't leave it lying around in the work area.

### **Skin protection**

419 Dermatitis is an inflammatory skin condition caused by certain irritants contained in many industrial materials. There are two general types:

- irritant dermatitis: usually caused by the skin coming into contact with an irritant substance. Anyone can be affected and the strength of the irritant together with the duration of exposure will affect the seriousness of the complaint;
- sensitising dermatitis: where a person develops an allergic reaction to a substance. The reaction may follow weeks, months or even years of use without any ill effects but once it has occurred, any future exposure to the substance will produce an adverse reaction.

420 Reaction of the skin to an irritant varies from one individual to another. The reaction may be only a mild redness but this can develop into swelling, blisters and septic ulcers that are both unsightly and painful (see Figure 46). In addition to dermatitis, some substances can cause other skin problems, such as oil acne from bitumen-based products and skin ulcers from corrosive substances.



**Figure 46** A person suffering from dermatitis

421 In the course of their work, construction workers may come into contact with many skin irritants. The most common types include:

- cement, lime and plaster;
- paint;
- tar, pitch and bitumen;
- solvents, thinners and de-greasers;
- certain epoxy, acrylic and formaldehyde resins;
- mineral oils and grease.

422 Where protective clothing is provided (such as overalls and gloves), it must be of the right type to protect the wearer against the particular hazard they are going to encounter. All manufacturers offer advice on the most suitable gloves for specific types of hazard. When using gloves to help prevent dermatitis, users must avoid getting contaminants inside the gloves when putting them on and taking them off.

423 It is also essential to provide washing facilities, with a supply of hot and cold (or warm) running water, soap and a means of drying the hands, to help prevent dermatitis.

424 Advice on general PPE is contained in paragraphs 530-546, and advice on measures to protect against noise and vibration can be found in the sections specific to those topics.

### **Personal hygiene**

425 Substances can also be a hazard to health when they are transferred from workers' hands onto food, cigarettes etc and so taken into the body. This can be avoided by good personal hygiene, eg by:

- washing hands and face before eating, drinking and smoking and before, as well as after, using the toilet;
- eating, drinking and smoking only away from the work area.

426 In cases where clothing may become contaminated, people should change out of this clothing before eating and drinking.

427 Make sure those at risk know the hazards. Provide good washing facilities and somewhere clean to eat meals. Good clean welfare facilities can play an important part in protecting the health of everyone involved in the work.

428 Make sure as few people as possible are exposed to hazardous substances by excluding people not directly involved in the work from the contaminated area.

429 Further details of COSHH requirements, including the text of the Regulations themselves, are given in the *COSHH Approved Code of Practice and guidance*.<sup>19</sup>

### **Health surveillance**

430 Sometimes workers' health can be protected by checking for early signs of illness. Such surveillance is a legal duty in a restricted range of cases for work involving some health risks such as asbestos. Surveillance may be appropriate in other cases, eg for workers regularly engaged in blast-cleaning surfaces containing silica, or where workers are exposed to high levels of noise or hand-arm vibration, especially for long periods.

431 Where appropriate, arrangements should be made for workers to have regular examinations by an occupational health professional to detect early signs of skin complaints, such as dermatitis. In addition, workers should be encouraged to carry out 'self-checks' and report skin irritations to their supervisor at an early stage.

## Asbestos

432 Asbestos-related diseases kill more people than any other single work-related cause. All types of asbestos can be dangerous if disturbed. The danger arises when asbestos fibres become airborne. They form a very fine dust which is often invisible. Breathing asbestos dust can cause serious damage to the lungs and cause cancer. There is no known cure for asbestos-related disease.

433 The more asbestos dust inhaled, the greater the risk to health. Until recently it was thought that those dying from asbestos-related diseases were regularly exposed to large amounts of asbestos. It is now thought that repeated low exposures or occasional high exposures to asbestos can lead to asbestos-induced cancers, although the exact scale of risk at lower levels of exposure is unknown. Therefore precautions should always be taken to prevent exposure, or where this is not practicable, to keep it to a minimum. Workers such as plumbers, electricians and heating engineers may not consider that they work with asbestos, but they might regularly drill, cut and handle materials containing asbestos and need to be protected.

434 The free HSE leaflet *A short guide to managing asbestos in premises*<sup>20</sup> contains essential guidance for those who own, occupy, manage or have responsibilities for non-domestic premises that may contain asbestos.

435 Asbestos is a very durable fibre. It was widely used in materials where resistance to heat or chemical attack was important and to give strength to cement products such as insulation boards, corrugated roof sheets and cement guttering and pipe work. Sprayed asbestos coatings have also been used to reduce noise.

436 In May 2004, regulation 4 of the Control of Asbestos at Work Regulations 2002<sup>17</sup> came into force. Since then, anyone responsible for maintenance and repair of a commercial or industrial property has an explicit duty to identify asbestos in the premises and manage the risk. In summary, this means they must:

- check whether there is any asbestos present;
- check on its condition;
- assume the material contains asbestos unless there is strong evidence to the contrary;
- assess the risks from any asbestos-containing material;
- take action to manage the risk so that no one will unknowingly disturb asbestos; and
- provide information about the material to anyone likely to disturb it.

437 Building and maintenance contractors should no longer be unsure about when they will come across asbestos in commercial buildings as, under the duty to manage asbestos in non-domestic premises, the building owner/occupier is required to provide information about the presence of asbestos on their premises. Often the presence of asbestos will not be obvious and it is not always easy to identify asbestos from its appearance. Unless the building owner can produce clear records to show that the area where work is to be done is free from asbestos, it is sensible to assume that any buildings constructed or refurbished before the 1990s are likely to contain asbestos-based materials. Figure 47 shows some of the typical locations for the most common asbestos-containing materials.

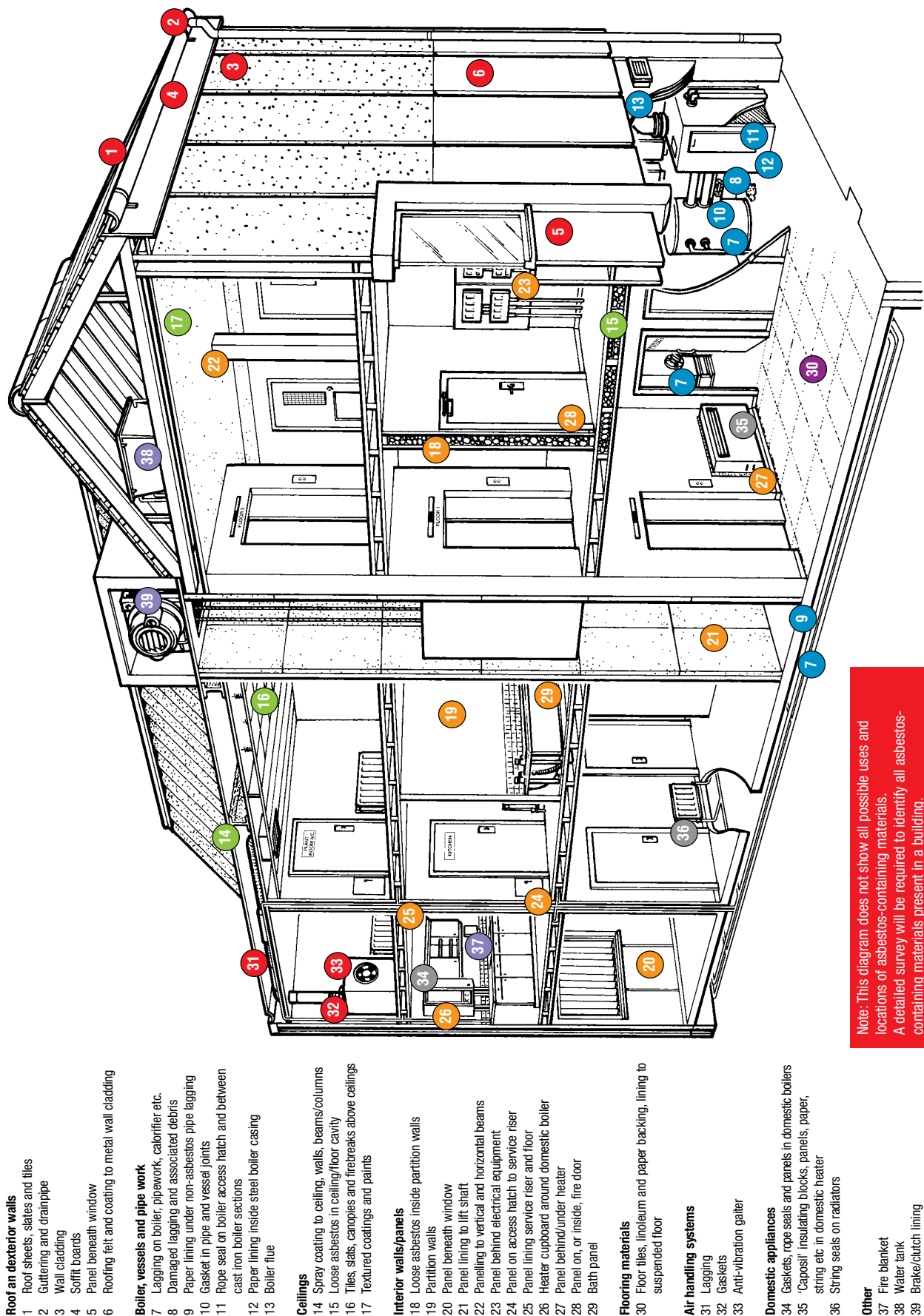

Figure 47 Typical locations for the most common asbestos-containing materials

438 Do not carry out any work that is likely to expose employees to asbestos unless an adequate assessment of exposure has been made. This means that the building or area of the building where work is to be done should be checked to identify the location, type and condition of any asbestos that could be disturbed during the work.

439 Some of the most common materials containing asbestos are (see Figures 48a–48g):

- boiler and pipe-work coatings and laggings;
- sprayed coatings providing fire or acoustic insulation;
- insulation board;
- cement-based sheets and formed products, such as facias, soffits, gutters and downpipes etc;
- ceiling (and some floor) tiles;
- gaskets and paper products used for thermal and electrical insulation;
- some textured surface coatings.



**Figure 48a** Asbestos-insulated water pipes showing evidence of maintenance work damage, with detached preformed sections and calico wrapping



**Figure 48b** Poorly tamped sprayed chrysotile fireproofing on a structural steel beam holding up a concrete floor, showing some overspray onto the concrete and damage by electrical work

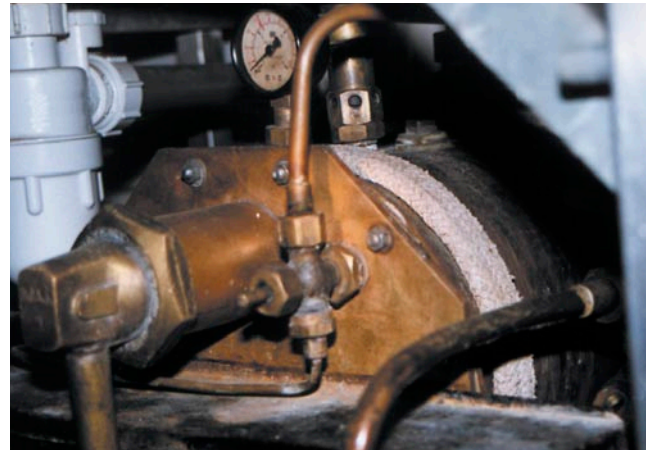

**Figure 48c** Painted asbestos insulating board facing to a fire door with some damage around the door furniture





**Figure 48d** Asbestos cement downpipe, hopper and profile sheet



**Figure 48f** Asbestos rope seal in a domestic gas boiler



**Figure 48e** Asbestos-containing vinyl floor tiles



**Figure 48g** Painted asbestos-containing textured coating on a ceiling

440 Further information can be found in *Working with asbestos in buildings*,<sup>21</sup> which contains essential guidance for workers in the maintenance or building refurbishment trades.

441 In general, the softer the material, the more easily it is damaged and the more likely it is to release fibres when disturbed or worked on. The greater the fibre release, the greater the risk to health it will generate and the higher the standard of precautions required when working with that material. Many of the softer materials, eg boiler lagging, will be protected by a hard outer coating. If the protective outer coating could be inadvertently damaged during the work, take precautions either to protect it or to ensure that if it is damaged, the subsequent release of asbestos will not create a risk. Work in which asbestos insulation, asbestos coating or asbestos insulating board is removed, repaired or disturbed will normally have to be carried out by a specialist contractor licensed under the Asbestos (Licensing) Regulations 1983,<sup>22</sup> as amended.

442 If asbestos (or what is suspected to be asbestos) that was not identified during the initial assessment is discovered, stop work. Evacuate the area and protect the asbestos from further damage until it has been decided how work can proceed in safety. If there is doubt about the presence of asbestos, seek the advice of a specialist analyst.

443 All work with asbestos and the precautions needed are covered by the Control of Asbestos at Work Regulations 2002<sup>17</sup> and the supporting *Approved Code of Practice and guidance*.<sup>23</sup> The Regulations place a duty on an employer to prevent the exposure of employees to asbestos, or to reduce exposure to the lowest reasonably practicable level. So, if possible, a work method which avoids any disturbance of asbestos-containing materials should be chosen. If this is not possible, before carrying out any work that is liable to expose employees (or others) to asbestos, make an assessment of the likely exposure.

444 It is important to make this assessment even when exposure to asbestos is infrequent and only happens by chance, eg during building refurbishment or repair work such as gas fitting, plumbing or electrical work. The assessment will help in deciding what precautions need to be taken to protect people who may be affected by the work.

445 Apart from a few limited exemptions, the Asbestos (Licensing) Regulations 1983<sup>22, 24</sup> prohibit contractors working on asbestos insulation, asbestos coating or asbestos insulating board unless they have a licence issued by HSE. This is specialist work usually requiring the erection of enclosures around the work, filtered and powered ventilation for the enclosure, high-efficiency powered respirators and separate changing and showering facilities.

446 Essential points to remember when working with small quantities of hard asbestos-containing materials:

- There is no requirement for a licence to work on asbestos-cement sheet, or with asbestos-cement products like ducts and pipe work, but the work must be done in compliance with the Control of Asbestos at Work Regulations 2002.<sup>17</sup> Make sure the material comes within the definition of asbestos cement before starting work by having a density measurement taken. An assessment of exposure is always required. Avoid exposure to airborne dust and provide necessary protective equipment, including respirators. **Only use respirators to control exposure after all other steps to reduce exposure have been taken.** Further information can be found in the publication *Working with asbestos cement*.<sup>25</sup>
- Apart from a few exemptions, work with asbestos coating, asbestos insulation, or asbestos insulating board requires a licence. Before starting work, check whether a licensed contractor should be doing it.
- Where exposure is to low levels of fibre, eg when removing small numbers of good condition ceiling tiles or drilling a few holes as part of plumbing or electrical work, disposable respirators may give adequate protection. For more extensive work involving breaking boarding or handling damaged materials, more precautions will be necessary, such as full-face respirators, disposable overalls and ventilated enclosures, as required when working with lagging.
- Don't break asbestos board or sheeting; try to remove it as an undamaged piece. Where sheet has to be worked on, wet it first. Handle the material carefully – don't drop materials onto the floor or ground. Pick up loose pieces immediately. If working outdoors (eg taking down roof sheets) make sure vehicles don't run over sheets at ground level – this results in high dust levels.
- Use hand tools – drilling and cutting sheet with power tools produces a lot of dust. Use the working methods and precautions described in the asbestos guidance referred to in this section. Avoid blasting, sanding and grinding the material.
- If asbestos materials are removed, they must be disposed of safely. Board and sheet materials should usually be wrapped and sealed in polythene sheet and marked to indicate the presence of asbestos. Only specified tips accept asbestos-containing waste; check with the appropriate waste authority who will be able to provide information on the relevant hazardous waste legislation.

447 The Asbestos (Prohibitions) (Amendment) Regulations 1999<sup>26</sup> prohibit the import, supply and use of all types of asbestos and products containing them, apart from a few exemptions allowing the continued use of chrysotile (white) asbestos in very specialised circumstances.

448 Further guidance is available in *Introduction to asbestos essentials*<sup>27</sup> and *Asbestos essentials task manual*,<sup>28</sup> which contains task guidance sheets for short-duration work with asbestos-containing materials, aimed at the building maintenance and allied trades.

## **Noise**

449 Regular exposure to high noise levels causes deafness or tinnitus (a permanent sensation of noise and ringing in the ears) – the longer the exposure and the higher the noise level, the greater the degree of hearing loss. It may only be when damage caused by exposure to noise over the years combines with normal hearing loss due to ageing that people realise how deaf they have become. This hearing loss is incurable and distressing.

450 Employers have duties to control this risk under the Control of Noise at Work Regulations 2005,<sup>29</sup> which sets out levels at which action must be taken. The exposure of anyone to noise from work activities should be assessed and controlled. Where risks to hearing have been controlled to the lowest level practicable, hearing protection should be provided if risks remain.

451 Noise on construction sites usually comes from machinery used for demolition, excavation or piling and from compressors and concrete mixers etc. Other operations, such as hammering, riveting and the use of cartridge-operated fixing tools, may also be the source of excessive noise. Check which work will involve noisy equipment. Assess how much the noise from this work is going to affect people working at the site.

452 The manufacturers and suppliers of equipment have a legal duty to provide information on the noise their equipment produces. This information should give a good idea if there is likely to be a noise problem. Go back to the manufacturer or supplier if the information is not clear. Where possible, choose low-noise tools and equipment.

453 Poor maintenance of tools can lead to increased noise levels. You need to make sure that equipment is properly maintained and that any noise reduction measures, such as pneumatic silencers, are kept in place.

## **Assessment**

454 Look at how equipment will actually be used on site. Can the person using the equipment talk to someone 2 m away without having to shout to be understood? If they have to shout, the noise from the equipment is probably loud enough to damage their hearing, so action will have to be taken.

455 Get the noise levels assessed by someone with the skill and experience to measure noise and who can identify what needs to be done. In the meantime, offer workers ear defenders ( earmuffs or earplugs) to wear.

456 Tell all workers exposed above the action levels that there is a risk to their hearing, what is being done about it and what they are expected to do to minimise the risk.

### Prevention

457 Can the job be done in another way that does not involve using noisy equipment? If not, can a quieter item of equipment be used? When buying or hiring equipment, choose the quietest model. Try and carry out the noisy job well away from where other people are working. Move workers who are not involved out of the noisy area. Erect signs to keep people out of the noisy area.

### Control

458 Try and reduce the noise at source, eg fit mufflers to breakers, drills etc. Keep the covers closed on compressors. Most modern compressors are designed to run with all covers closed, even in hot weather. Make sure the silencers on mobile plant are in good condition. Maintain equipment regularly to prevent noise from loose bearings and leaky compressed-air hoses and joints.

459 Noise levels can be reduced by making sure the exhausts of compressors, generators and other plant are directed away from work areas. Screens faced with sound-absorbent materials can be placed around plant.

460 If it is not possible to eliminate the noise source or reduce the noise, provide workers with ear defenders (muffs or plugs). Providing hearing protection is **not** a substitute for noise elimination and control at source.

461 Carefully select ear defenders, keep them in good condition and train workers in their use. Ensure that they fit well and are kept in good condition. Make sure that where defenders are needed they are actually used. Check that the hearing protection does not interfere with other safety equipment, eg if ear defenders are difficult to wear with a hard hat, get defenders that fit onto the hat.

462 For further information read *Noise in construction*.<sup>30</sup>

### Vibration

463 Many jobs in construction involve the use of hand-held power tools. The vibration from such equipment can cause hand-arm vibration syndrome (HAVS). This condition affects the fingers, hands and arms and, in the long term, causes permanent damage. Eventually parts of the fingers go white and numb and there is a loss of touch. This condition is often called 'vibration white finger'.

464 Vibration damage to the fingers, hands or body is very much dose-related. The greater the exposure to vibration, the more likely there is to be damage. Other factors that can influence the degree of severity of hand-arm vibration syndrome include:

- the grip, push and other forces used to guide and apply the vibrating equipment. The tighter the grip, the more vibration energy is transferred to the hands;
- the exposure pattern, length and frequency of work and subsequent rest periods;
- the hardness of the material being worked upon; and
- factors that can affect blood circulation, such as workplace temperature, smoking and individual susceptibility.

465 While all vibration can be damaging, it is perhaps logical to assume that the faster a machine vibrates, the more dangerous it is, whereas in fact it is lower-speed vibrations (those between about 2 and 64 vibrations per second) that cause the most damage. Some of the tools used in construction that are likely to result in high levels of exposure to vibration are:

- road and concrete breaking drills;
- concrete vibro thickeners and concrete pokers;
- plate vibrators;
- chisels (air or electric);
- compressor guns;
- pneumatic and percussive drills;
- angle grinders;
- sanders and other similar 'rotary' tools;
- abrasive wheels;
- cutting-off wheels and discs;
- power hammers and chisels.

466 The Control of Vibration at Work Regulations 2005<sup>31</sup> give employers responsibilities to control the risk of vibration. They set out specific requirements relating to assessment, control and action levels.

467 If anyone uses hand-held power tools, they should identify, assess and prevent or control the risk from vibration.

468 The manufacturer or supplier's information should indicate if there is a vibration problem. Go back to the manufacturer or supplier if the information is not clear. Where possible, choose low-vibration tools.

### **Assessment**

469 The information from the manufacturer or supplier, the amount of time the tools are used and discussions with the people using the tools should reveal the tools most likely to present a risk.

470 Make sure workers using vibrating tools know about the risks and what they need to do to minimise them. Further information for workers is provided by HSE's guidance *Hand-arm vibration: Advice for employees*.<sup>32</sup>

### **Prevention**

471 Can the job be done in another way that does not involve using hand-held power tools (eg by using a hydraulic breaker to break a concrete beam rather than spending long periods using hand-held breakers or using a chemical method for pile capping or surface preparation)?

### **Control**

472 Maintain equipment so that it is properly balanced, has no loose or worn out parts and blades/cutters are sharp etc. Use the power tool and attachment which will do the job properly in the shortest time.

473 It is good practice for workers to keep their hands warm to get a good flow of blood into the fingers by:

- wearing gloves;
- having hot food or drinks;
- massaging the fingers;
- not smoking (as this can cause narrowing of the blood vessels).

474 For further information on vibration, see HSE's guidance *Hand-arm vibration. The Control of Vibration at Work Regulations 2005. Guidance on Regulations*<sup>33</sup> and *Control the risks from hand-arm vibration. Advice for employers on the Control of Vibration at Work Regulations 2005*.<sup>34</sup>

## Electricity

475 Electrical equipment is used on virtually every site. Everyone is familiar with it, but unlike most other hazards, which can be seen, felt or heard, there is no advance warning of danger from electricity, and **electricity can kill**.

476 Electrical systems and equipment must be properly selected, installed, used and maintained. Hazards arise through faulty installations, lack of maintenance and abuse of equipment. Accidents happen because people are working on or close to equipment which is either:

- assumed to be dead, but is in fact live; or
- known to be live, but workers have not received adequate training or adequate precautions have not been taken.

477 It is essential that the electricity power supply requirements are established before any work takes place. Arrangements for the electricity supply should be completed with the local electricity supplier and the supply system installed. Guidance on requirements for low voltage (ie 400 and/or 230 volt ac systems) can be found in BS 7671.<sup>35</sup>

478 Electrical equipment used on building sites (particularly power tools and other portable equipment and their leads) faces harsh conditions and rough use. It is likely to be damaged and therefore become dangerous. Modern double-insulated tools are well protected, but their leads are still vulnerable to damage and should be regularly checked.

479 Where possible, eliminate risks. Cordless tools or tools which operate from a 110V supply system, which is centre-tapped to earth so that the maximum voltage to earth should not exceed 55V, will effectively eliminate the risk of death and greatly reduce injury in the event of an electrical accident. For other purposes such as lighting, particularly in confined and wet locations, still lower voltages can be used and are even safer.

480 If mains voltage has to be used, the risk of injury is high if equipment, tools, leads etc are damaged, or there is a fault. Residual current devices (RCDs or trip devices as they are sometimes called) with a rated tripping current not greater than 30 mA with no time delay will be needed to ensure that the current is promptly cut off if contact is made with any live part.

481 RCDs must be installed and treated with great care if they are to save life in an accident. They have to be kept free of moisture and dirt and protected against vibration and mechanical damage. They need to be properly installed and enclosed, including sealing of all cable entries. They should be checked daily by operating the test button. If mains voltage is to be used, make sure that tools can only be connected to sockets protected by RCDs. By installing an RCD at the start of the work, immediate protection can be provided. Even so, RCDs cannot give the assurance of safety that cordless equipment or a reduced low-voltage (such as 110V) system provides.

482 Mains equipment is more appropriate to dry indoor sites where damage from heavy or sharp materials is unlikely. Where mains leads to sockets may be damaged, they should be:

- positioned where they are least likely to be damaged, eg run cables at ceiling height; or
- protected inside impact-resistant conduit.

483 Alternatively, special abrasion-resistant or armoured flexible leads can be used.

484 Electrical systems should be regularly checked and maintained. Everyone using electrical equipment should know what to look out for. A visual inspection can detect about 95% of faults or damage. Before any 230V hand tool, lead or RCD is used, check that:

- no bare wires are visible;
- the cable covering is not damaged and is free from cuts and abrasions (apart from light scuffing);
- the plug is in good condition, eg the casing is not cracked, the pins are not bent and the key way is not blocked with loose material;
- there are no taped or other non-standard joints in the cable;
- the outer covering (sheath) of the cable is gripped where it enters the plug or the equipment. The coloured insulation of the internal wires should not be visible;
- the equipment outer casing is not damaged and all screws are in place;
- there are no overheating or burn marks on the plug, cable or the equipment;
- RCDs are working effectively, by pressing the 'test' button every day.

485 Workers should be instructed to report any of these faults immediately and stop using the tool or cable as soon as any damage is seen. Managers should also arrange for a formal visual inspection of 230V portable equipment on a weekly basis.

486 Damaged equipment should be taken out of service as soon as the damage is noticed. **Do not carry out makeshift repairs.**

487 Some faults, such as the loss of earth continuity due to wires breaking or coming loose within the equipment, the breakdown of insulation and internal contamination (eg dust containing metal particles may cause shorting if it gets inside the tool), will not be spotted by visual inspections. To identify these problems, a programme of testing and inspection is necessary. This testing and inspection should be carried out by someone trained to do this. As well as testing as part of the planned maintenance programme, combined inspection and testing should also be carried out:

- if there is reason to suspect the equipment may be faulty, damaged or contaminated, but this cannot be confirmed by visual inspection; and
- after any repair, modification or similar work to the equipment, which could have affected its electrical safety.

488 Similar checks to those recommended for 230V hand tools are appropriate for other site electrical equipment. Suggestions for inspections and test frequencies are set out in Appendix 1.

489 With lighting systems, provide protection for cabling in the same way as for tools. Protect bulbs against breakage. If breakage does occur, the exposed filaments may present a hazard. Make sure there is a system for checking bulbs to maintain electrical safety and also to keep the site well lit.

490 Tools and equipment should be suitable for site conditions. DIY tools and domestic plugs and cables are not designed to stand up to everyday construction work. Also observe other restrictions on use imposed by manufacturers.

491 If work is to be done in areas where there is a risk of flammable vapours (such as in a petrochemical works), it will be necessary to select specially designed electrical equipment to prevent it acting as a source of ignition due to sparks and overheating. Precautions should be covered in the project health and safety plan and the operator of the premises should be able to provide advice. Specialist advice may also be needed.

492 Further information on controlling electrical risks can be found in *Electrical safety on construction sites*.<sup>36</sup> Information on risks from underground services can be found in paragraphs 366-381.

### Overhead power lines

493 Contact with overhead power lines is a regular cause of death and injury. Any work near electric distribution cables or railway power lines must be carefully planned to avoid accidental contact.

494 The most common operations leading to contact with overhead lines are:

- operating cranes and other lifting equipment;
- raising the body or inclined container of tipper lorries;
- operating excavators and other earth-moving equipment;
- handling long items such as scaffold tubes, metal roof sheets, ladders etc;
- using MEWPs.

495 Where possible all work likely to lead to contact with the overhead line should be done in an area well clear of the line itself. Where this is not feasible, either the power line must be made **dead** or suitable precautions must be taken to prevent any danger. For some jobs, it may be necessary for the electricity supplier to isolate or re-route overhead lines to enable work to proceed.

496 In some cases it may be possible to alter the work to eliminate the risk, eg by reducing the length of scaffold tubes, ladders or roof sheets to ensure that the line cannot be contacted accidentally.

497 If plant is working in the vicinity of an overhead power line, the distance between the plant and the overhead line should be **at least**:

- 15 m (plus the length of the jib) if the lines are suspended from steel towers; or
- 9 m (plus the length of the jib) if the lines are supported on wooden poles.

498 In cases where approach is likely, stout, distinctive barriers should be erected at ground level to prevent access (see Figure 49). Where work is to take place close to overhead lines, detailed precautions should be discussed with the owner of the lines (any work next to any railway where the work is likely to encroach onto railway land should in any case be discussed with the railway operator before work begins). However, the responsibility for ensuring that precautions are adequate remains with the contractors undertaking the work, **not** with the owner of the power lines.



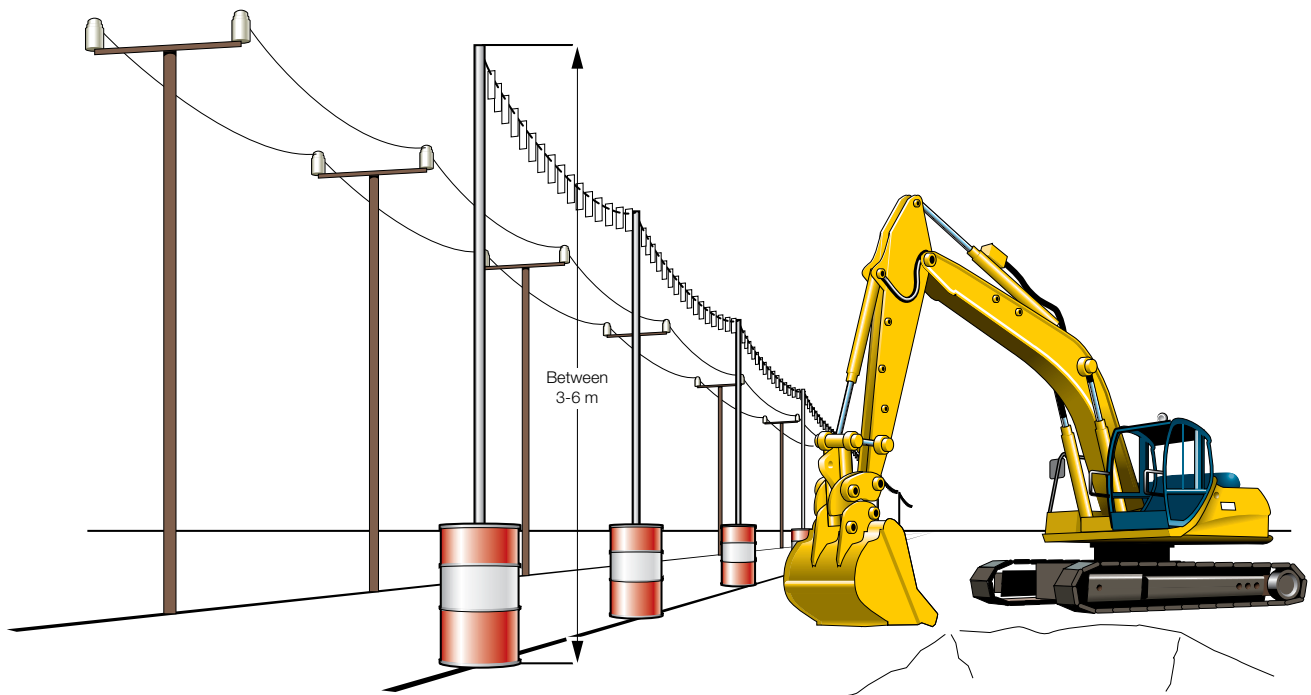

**Figure 49** Ground-level barrier for plant working near an overhead power line

499 In addition to the specific precautions required when working in the vicinity of overhead power lines, you should also:

- erect high-visibility barriers at least 6 m away, to prevent inadvertent approach by other site vehicles (see Figure 50);
- install clearly marked crossing points beneath the lines at a height specified by the electricity supplier;
- prohibit the storage of materials in the area between the overhead lines and the ground-level barriers.

500 For more information, read *Avoidance of danger from overhead electric powerlines*.<sup>37</sup>

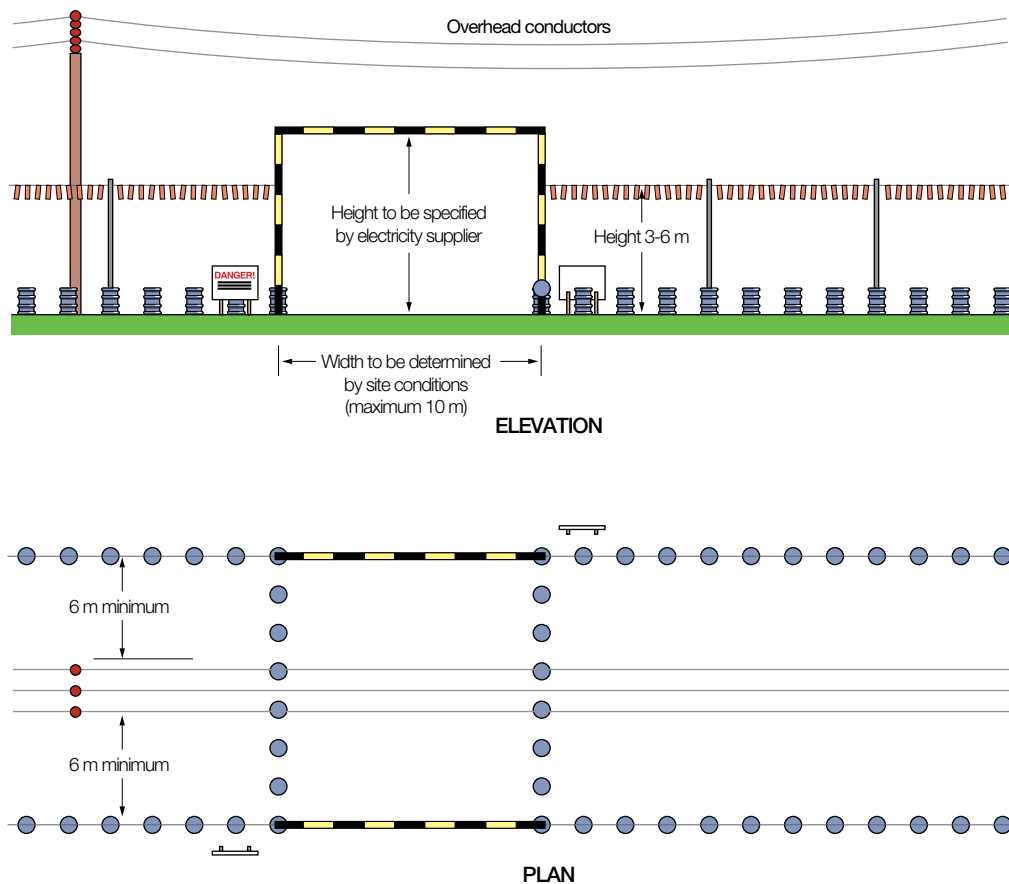

Figure 50 Diagram showing normal dimensions for 'goal post' crossing points and barriers

## Slips and trips

501 Something as simple as a slip or trip is the single largest cause of injuries on construction sites, leading to more than 1000 major injuries being reported each year. Most of these injuries can be easily avoided by effective management of those areas of the site where workers need access, such as corridors, footpaths, stairwells and site cabins.

502 The main causes of this type of accident are:

- having to walk over uneven ground, particularly when carrying unwieldy objects;
- tripping over building materials or waste which has simply been left lying around;
- tripping over trailing cables;
- slipping caused by wet surfaces or poor ground conditions;
- trips caused by small changes in level.

503 Although each of the problems can be dealt with quite simply, in practice it is difficult because site conditions are constantly changing. It is therefore essential that site managers exercise good control and that everybody working on site takes responsibility for ensuring that the way they do their work does not create a risk for others, eg due to leaving trailing cables across corridors or leaving waste materials in stairwells.

504 What can you do to prevent accidents?

- Keep the work and storage areas tidy.
- Plan deliveries to minimise the amount of materials on site.
- Make sure corridors, stairways, footpaths and other areas used by pedestrians are kept clear of obstructions at all times.
- Have clearly designated walkways with good conditions underfoot (leveled if rutted, stoned if muddy, gritted when icy).
- Where small changes of level cannot be avoided (eg doorways into buildings) consider the use of soundly constructed temporary ramps or some other way of providing easy and safe access.
- Have proper arrangements for the disposal of waste materials, eg provide clearly identified areas where waste can be left for later collection. Don't forget that this is just as important for work inside buildings; you might want to consider providing wheelie bins or wheeled skips for people to put their rubbish in. Ask yourself the following questions:
  - Whose job is it to clear up the waste?
  - How often does this need to be done?
  - Are bins provided? By whom? How many? Where are they positioned?
  - Who empties the bins? Where to? How do they do this?
  - Whose job is it to make sure the waste is removed from site?
- Keep inside and outside work areas adequately lit.
- Pay particular attention to maintaining good conditions at the foot of access stairs and ladders.
- Ensure everybody on site wears footwear that provides good grip.
- Use cordless tools when possible to avoid having to manage cable runs.
- Where cables are needed for temporary lighting or mains-powered tools, run these at high level, particularly along corridors.
- If temporary coverings are used to protect finished floor surfaces, make sure these do not create a risk of slipping or tripping.
- Use mechanical plant to move materials to storage areas that are convenient to where they will be used. This will reduce the need to carry objects over poor ground.
- Make sure that steps leading to site cabins are properly constructed.
- Make sure everyone knows what they have to do to manage their own materials, waste and equipment to keep the site tidy and reduce the risk of tripping.

## Working in confined spaces

505 Not knowing the dangers of confined spaces has led to the deaths of many workers. Often those killed include not only those working in the confined space but also those who try to rescue them but who are not properly equipped to carry out the task safely.

506 Inadequate planning and insufficient knowledge are a major cause of accidents in confined spaces. Accidents are caused by a combination of factors arising from a lack of safety awareness, inadequate supervision and a lack of training. It is therefore essential that work in such spaces is only undertaken by skilled and trained people. If work in a confined space cannot be avoided, it will often be safer to bring in a specialist for the job.

### **What is a confined space?**

507 Under the Confined Spaces Regulations 1997,<sup>38</sup> a 'confined space' can be either:

- a place which is substantially, though not always entirely, enclosed; or
- a place where there is a reasonably foreseeable risk of serious injury from hazardous substances or conditions within the space or nearby.

508 Some confined spaces are easy to identify, such as closed tanks, vessels, ducts and sewers. Other are less obvious, such as basement rooms, toilets, building voids, vats, deep excavations and open-topped tanks. Of course a confined space may not necessarily be enclosed on all sides or may only become a confined space because of a change in the conditions inside.

### **Why is a confined space dangerous?**

509 Air in the confined space is made unbreathable either by harmful gases and fumes or by lack of oxygen. There is not enough natural ventilation to keep the air fit to breathe. In some cases the gases may be flammable, so there may also be a fire or explosion risk.

510 Working space may be restricted, bringing workers into close contact with other hazards such as moving machinery, electricity or steam vents and pipes. The entrance to a confined space, eg a manhole, may make escape or rescue in an emergency more difficult.

### **How does a confined space become dangerous?**

511 Some confined spaces are naturally dangerous, eg because of:

- gas build-up in sewers and in manholes and pits connected to them;
- gases leaking into trenches and pits in contaminated land such as old refuse tips and old gas works;
- rust inside tanks and vessels, which eats up the oxygen;
- liquids and slurries, which can suddenly fill the space or release gases into it when disturbed;
- chemical reaction between some soils and air causing oxygen depletion, or the action of ground water on chalk and limestone producing carbon dioxide.

512 Some places are made dangerous by vapours from the work done in them. Keep hazards out of confined spaces. Do not use petrol or diesel engines because exhaust gases are harmful. Paints, glues etc may give off hazardous vapours. Ensure the confined space has enough ventilation to make the air fit to breathe. Mechanical ventilation might be needed.

### **How do I work safely?**

513 There should be a safe system of work for operations inside confined spaces. Everyone should know and follow the system. A permit-to-work system may be required.

514 For safe working, first try to find a way of doing the job without going into the confined space. If entry is essential:

- identify what work must be done in the confined space and the hazards involved;
- consider if the space could be altered to make it permanently safe or if the work could be changed to make entry to the dangerous area unnecessary;
- make sure workers have been trained in the dangers and precautions, including rescue procedures;
- make sure the entrance to the space is big enough to allow workers wearing all the necessary equipment to climb in and out easily;
- before entry, ventilate the space as much as possible, test the air inside the space and only enter if the test shows it is safe;
- after entry, continue to ventilate the space and test the air for toxic substances, flammable gases and oxygen deficiency as necessary;
- if there is a flammable risk, the space must be ventilated until it is safe. When selecting equipment, remember heat or sparks from electrical or other equipment could ignite flammable vapours, so air-powered tools may be required. The risk from flammable vapours is very high when work is carried out on the tanks of petrol service stations and similar sites. This is work which may be safer left to a specialist contractor;
- disturbing deposits and slurries in pipes and tanks may produce extra vapour, resulting in a greater risk, so clear deposits before entry where possible;
- if the air inside the space cannot be made fit to breathe because of a toxic risk or lack of oxygen, workers must wear breathing apparatus;
- never try to 'sweeten' the air in a confined space with oxygen as this can produce a fire and explosion risk;
- workers inside the confined space should wear rescue harnesses with lifelines attached, which run back to a point outside the confined space (see Figure 51);
- someone should be outside to keep watch and to communicate with anyone inside, raise the alarm in an emergency and take charge of rescue procedures if it becomes necessary. It is essential those outside the space know what to do in an emergency. They need to know how to use breathing apparatus if they are to effect a rescue.

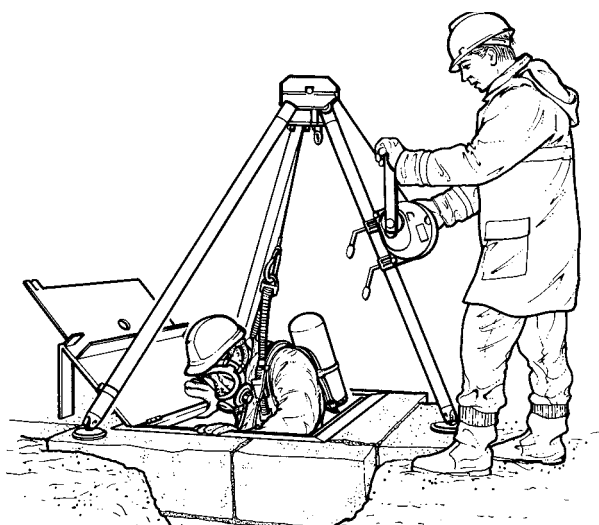

**Figure 51** A worker wearing full breathing apparatus is also wearing a harness and lanyard connected to a winch so that he can be hauled to the surface in an emergency without others having to enter the manhole to rescue him

515 For further information on working in confined spaces, read *Safe work in confined spaces*.<sup>39</sup>

## Prevention of drowning

516 There is a risk of drowning when people work beside or above water or have to pass near or across it on their way to or from their workplace. People can also drown in other liquids such as slurries in lagoons, foodstuffs in open vats in food processing works and solutions of chemicals in factories.

517 If people have to work over or in the vicinity of water, there must be a safe system of work, and they must be properly trained. Equally important is the provision of proper equipment and suitable emergency procedures, together with the information and training necessary to use the equipment and respond effectively in an emergency.

518 The most immediate danger following a fall into water is drowning. Causes or contributory factors include:

- shock of sudden immersion in cold water;
- weight of waterlogged clothing;
- incapacity following injury caused by striking an object during the fall or while in the water;
- fatigue or hypothermia where rescue is not immediate.

519 The measures given in paragraphs 520-529 should be taken to significantly reduce these risks.

### Preventing a fall into water

520 Erect barriers to stop people from falling into the water or other liquid. In most cases guard rails and toe boards or a similar barrier will be needed at open edges to ensure people cannot fall. In factories, farms and some other locations it may be possible to cover the surface of the container or to drain it.

521 A safe system of work also includes other considerations, eg diverting or reducing rates of flow in channels where possible by closing sluice gates and the arrangements for training and supervision of employees etc.

### Raising the alarm

522 When working over or near to water there should be means to raise the alarm if anyone has fallen into the water. It may be advisable to provide whistles and lights to help locate people in the water.

### Keeping afloat

523 Provide life jackets to those at risk. Life jackets should ideally be auto-inflating and should always be worn. They are designed to support an unconscious person in the water and turn them face upwards. It is essential that anyone who needs to wear a life jacket is trained in its use.

524 Buoyancy aids are intended to provide a conscious person with enough extra buoyancy to stay afloat and achieve a reasonably good floatation position, but they may not turn an unconscious person over from a face-down position.

### Grab and throw lines

525 A grab line can be tensioned across the river downstream of the work site to act as a safety feature. This line should be tensioned across the river so that it runs at 45 degrees to the flow, with the most downstream end to the bank from which easiest access can be made. This allows the swimmer to be washed to the downstream end as they hit the line. Do not tension the line at 90 degrees to the flow.

526 A throw line should not be tied to anything. For use in moving water it needs to be 8-12 mm diameter for ease of handling, brightly coloured and able to float to avoid entanglement on the river bed. If the force is too much to hold, the rescuer should walk down the bank recovering or releasing the line to avoid the possibility of the rescuer being pulled into the river. A tied or snagged line may have the effect of submerging the person in the water if the current is fast.

### Rescue boats

527 Suitable rescue boat or boats with a competent operator may be needed. This is particularly important when people may fall into the sea or flowing rivers. The boat should be designed so that it is easy to pull a casualty from the water into the boat. The type of rescue boat depends on the circumstances of the work and type of water and any currents. In fast-flowing water, two people may be necessary to carry out a rescue, one to manoeuvre the boat and the other to pull the casualty from the water.

528 To be effective, these precautions need to be maintained. People need to know what to do in an emergency and how to raise the alarm.

529 People are also at risk of drowning when they must travel by boat to reach their workplace, eg for certain work at docks, in rivers, at dams and on islands. Any boat used to convey people by water to or from a place of work should:

- be of suitable construction;
- be properly maintained;
- be under the control of a competent person; and
- not be overcrowded or overloaded.

## Protective equipment

530 This section gives advice about general personal protective equipment (PPE), which may be required to protect against injury.

### Hard hats

531 On almost all sites there is a risk of injury from falling materials. Minimise these risks by providing suitable barriers and toe boards at the edge of work platforms to prevent materials from falling. Deal with the remaining risks by providing suitable head protection.

532 The Construction (Head Protection) Regulations 1989<sup>40</sup> make specific requirements about hard hats. Hard hats are required where anybody might be struck by falling materials or where people might hit their heads.

533 These are just some of the hazards to consider:

- loose material being kicked into an excavation;
- material falling from a scaffold platform;
- material falling off a load being lifted by a crane or goods hoist or carried on a site dumper or truck;
- a scaffolder dropping a fitting while erecting or dismantling a scaffold.

534 Decide on which areas of the site hats have to be worn. Tell everyone in the area, if necessary make site rules.

535 Provide employees with hard hats. Make sure hats are worn and worn correctly. There are many types of hat available; let employees try a few and decide which is most suitable for the job and for them. Some hats have extra features including a sweatband for the forehead and a soft (or webbing) harness. Although these hats are slightly more expensive, they are much more comfortable and therefore more likely to be worn.

### **Footwear**

536 Is there a risk of injury from either:

- materials being dropped on workers' feet; or
- nails, or other sharp objects, penetrating the sole?

537 If so, boots with steel toecaps and mid-soles may be needed. Foot protection comes in many types and styles and manufacturers offer advice on the most suitable footwear for specific types of hazard.

538 Wellington boots are essential in preventing burns from wet cement or concrete as the cement content, when mixed with water, becomes highly corrosive and can cause severe burns to the skin.

### **Goggles and safety spectacles**

539 These are required to protect against:

- flying objects, eg when using a nail gun. To provide adequate protection goggles should be shatter-proof – check the manufacturer's specification;
- sparks, eg when disc-cutting;
- ultraviolet radiation from welding – specialist goggles or shields are required;
- chemical splashes.

540 Eye protection should be readily available in sufficient numbers so that any that are lost, destroyed or become defective can be replaced. If protection against corrosive splashes is needed, visors can protect the whole face.

### **Outdoor clothing**

541 Where employees regularly work outdoors and they cannot be sheltered from the weather, wind and waterproof clothing will be needed. There should be facilities for storing clothing not worn on site and protective clothing as well as for drying wet clothing (see paragraphs 61-65).



542 A major hazard to the skin is exposure to ultraviolet rays from the sun. The effects can vary from sunburn (blistering and peeling of the skin) to permanent damage and increased risk of skin cancer. Construction workers who are outdoors for long periods of time are at the greatest risk and should take steps to protect their skin by:

- wearing a long-sleeved top and covering their legs;
- regularly applying high-protection sun cream to exposed skin; and
- carrying out periodic checks for any visible changes in skin, such as changed or newly formed moles or any skin discolouration.

### **High-visibility clothing**

543 Many accidents happen when people in hazardous positions cannot be seen. It is important to plan work to avoid placing people in these positions. Where this is not possible, provide high-visibility clothing.

544 It is essential that this clothing be kept clean if it is to be effective. Badly soiled garments should be replaced.

545 High-visibility clothing will be needed wherever workers:

- could be run down by vehicles, eg signallers assisting with vehicles being manoeuvred and anyone engaged in roadworks;
- need to be seen by others to allow them to work safely, eg signallers assisting in lifting operations need to be clearly visible to the crane driver.

### **Gloves**

546 Suitable gloves can protect against dusts (such as cement), wet concrete and solvents, which can cause dermatitis. They can also protect against cuts and splinters when handling bricks, steel and wood. A range of different gloves should be available to suit different jobs and different workers.

## Work affecting the public

547 It is not only workers who are at risk from construction work. Members of the public are killed and seriously injured each year. The dead and injured include children.

548 Accidents often happen when people are walking near a building being built, refurbished or demolished, or walking near work in the street. Remember, when working in public areas, the work needs to be planned and executed to take account of the needs of children, people with prams, the elderly and those with disabilities.

### Keeping the public out

549 The best way to protect members of the public is to keep them out of the area where you are working. This is generally achieved by erecting a 2 m high perimeter fence or hoarding. If alterations are needed or some of the fencing needs to be taken down temporarily, make sure it is put back before leaving the site for meal breaks and at the end of the day. Lock the site gates and any other doors and windows at night.

550 If work is being done in occupied premises, clear responsibilities for maintaining the fencing and keeping those not involved in the work away need to be agreed with the building occupier.

551 If the site is near a school, or on or near a housing estate, it may be helpful to contact the head teacher or residents' association etc to seek their help to discourage children from trespassing.

552 Many children see construction sites as adventure playgrounds. Even though they may be entering the site without authority or may be trespassing, they should still be protected from site dangers; many will be too young to appreciate the risks they are running.

553 Take the following steps to reduce the chance of children injuring themselves if they do get onto the site. At the end of the working day:

- barrier off or cover over excavations, pits etc;
- isolate and immobilise vehicles and plant; if possible lock them in a compound;
- store building materials (such as pipes, manhole rings, cement bags etc) so that they cannot topple or roll over;
- remove access ladders from excavations and scaffolds; and
- lock away hazardous substances.

554 Security measures may also be needed. These can often strengthen safety measures.

### Falling materials

555 Protect passers-by with toe boards, brick guards and/or netting on scaffolding, but remember, most netting will only retain light material. Fans and/or covered walkways may also be needed where the risk is particularly high. Use plastic sheeting on scaffolds to retain dust, drips and splashes which may occur when cleaning building façades. Make sure the sheets do not make the scaffold unstable.

556 Tie down loose materials and remove debris from scaffold platforms. Do not stack material on scaffolds unless it is needed, and then not above the level of the toe board unless brick guards or another way of retaining material has been provided. Tie down scaffold boards if high winds are possible.

557 When using gin wheels or power-driven hoists, select a safe place where members of the public are not at risk.

558 Use debris chutes when removing debris into a skip. Cover over the skip to stop flying debris and cut down dust (see Figure 52).

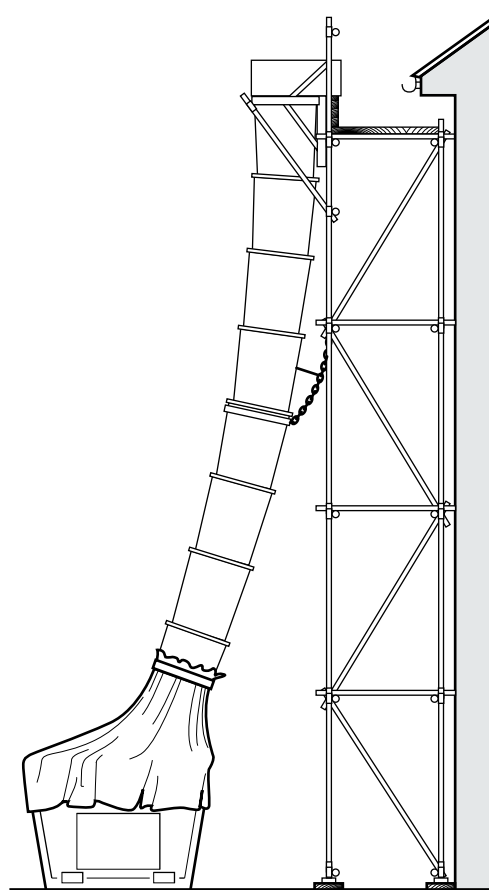

**Figure 52** A debris chute into a covered skip reduces the risk of flying debris

### Work in the roadway or footway

559 When working on the footpath or roadway, there could be a hazard to pedestrians and traffic. Road traffic may also present a hazard to the people on site. The Code of Practice, *Safety at street works and road works*<sup>41</sup> relating to the New Roads and Street Works Act 1991,<sup>42</sup> gives advice about traffic signing, the protection of work areas and pedestrian diversions.

560 When planning work in the roadway or footpath consider:

- signs for traffic and pedestrians to warn people about the work and the diversions they are expected to follow;
- temporary traffic controls and their maintenance;
- cones, and barriers to mark the safety zone within which the work can be carried out safely;
- barriers and tapping boards to protect the public. Barriers around street works perform two functions. First, they alert the public to the presence of such work and direct them to where they want to be via a protected area. Secondly, if members of the public do approach the site, the barriers should be of sufficient strength and stability to prevent them being injured if they fall;
- suitable temporary walking surfaces (including ramps if required) that are free of tripping hazards, paying particular attention to the needs of the elderly, those with prams, wheelchair users and visually impaired people;
- temporary lighting, which might be needed at night if there is insufficient street lighting;
- materials storage, eg do not leave paving slabs propped on edge, or pipes loosely stacked in areas where they might be disturbed. Do not store materials in the path of pedestrians and watch out for trailing cables;
- the movement of vehicles and plant into and out of the work area;
- providing high-visibility clothing for those working on or next to the roadway;
- other hazards, eg buried cables and support for the sides of excavations.

561 On some occasions, the pavement will have to be closed to protect the public, eg during pavement work, demolition work, façade cleaning, raising hot asphalt, scaffold erection or dismantling. The area may need to be barriered off and a safe alternative route provided for pedestrians (see Figure 53). Get in touch with the Highways Authority for advice.

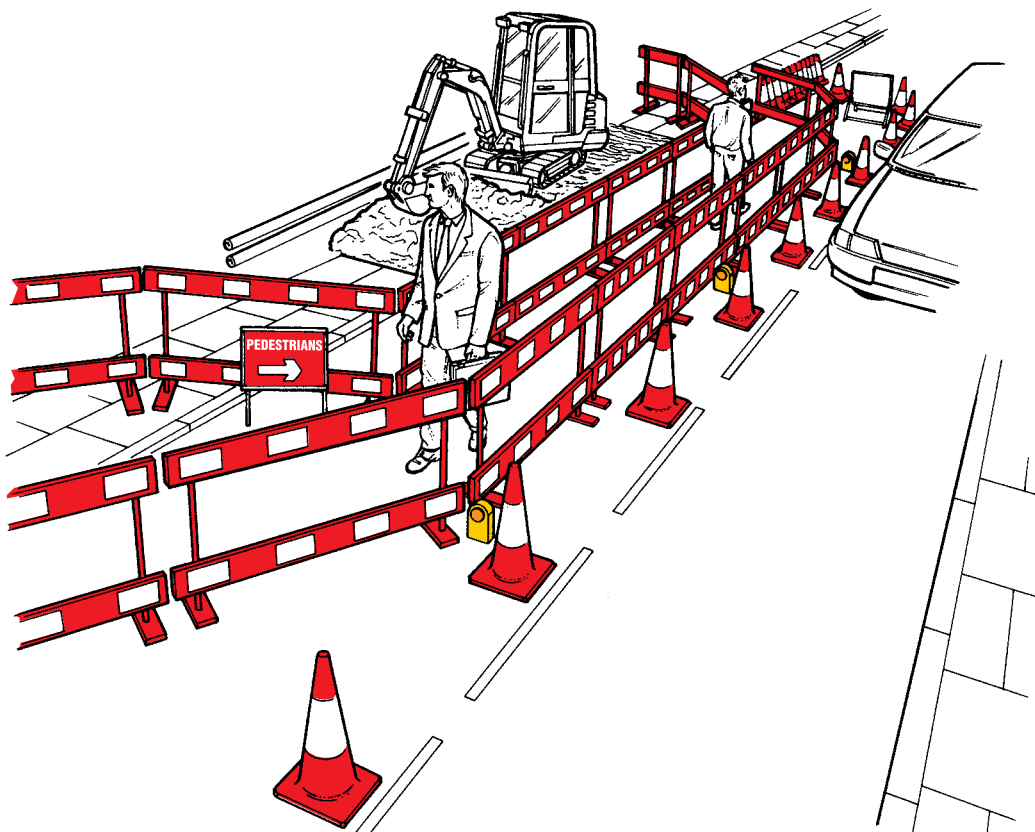

**Figure 53** Provide pedestrians with a protected route separated from the work and from traffic

### **Scaffolding**

562 Ensure that scaffolding does not present a danger to members of the public after it has been erected. Ensure that there are no protruding components that can injure people as they walk past. If a covered walkway is provided, make sure it is properly demarcated. Be aware of the needs of people with disabilities, eg visually impaired people may require tapping boards at low level to ensure they follow the protected route. Take steps to stop people gaining access to the scaffold when you are not on site by removing ladders at ground level. During refurbishment or repair work, think about additional places where access to the scaffold can be gained, eg from inside the building through a higher-level window, and take steps to avoid it.

### **Dusty and hot work**

563 Fence off hot work, such as welding or the use of disc cutters, to contain dust and sparks. Fence off bitumen and similar boilers which have to be sited in a public space.

### **Site visitors**

564 Make sure site visitors report to the person in charge of the site and know where to go – notices may be required at the site entrance. A waiting area may be needed. Visitors should not be allowed to wander around the site alone. A booking-in system may be needed on larger sites.

565 When housing estates are being built or properties are being refurbished, people not involved in the work who are unfamiliar with construction site hazards may well want to look around the site. Make sure they are accompanied at all times and given any necessary protective equipment such as helmets or boots. Programme operations so that work is not in progress on the parts of the site the public visit regularly. Arrange and sign access routes across the site to keep visitors away from site hazards.

566 For further information on preventing accidents to members of the public on construction sites, and other aspects of site security, see *Protecting the public: Your next move*.<sup>4</sup>

## Monitoring and reviewing

567 With any business activity, checks need to be made to make sure that what should be happening is actually being carried out in practice and that people are fulfilling their duties. Checking health and safety precautions are being taken is as important as checking progress and quality. Site supervisors need to see that their company considers the fulfilment of their corporate health and safety responsibilities as an essential part of the construction work.

568 Who is responsible for monitoring health and safety on site and are they trained and competent to carry out this role? How often should this monitoring be carried out and what system do you have in place to check that it is?

569 Who is responsible for managing and monitoring any contractors while they are on site to check they are working safely and to their method statement as agreed? Are contractors expected to sign in and report to a named site contact so that their presence on site is always known? What is your method of dealing with contracting firms or individual employees who fail to work safely?

570 If a safety adviser is employed to visit sites and review safety, do they report problems to the site manager and to the employer? Are matters put right and how will you receive confirmation of this? Do the same problems keep recurring? If there are problems, find out why.

571 Act before there is an accident or someone's health is damaged. Keeping a record of accidents, illnesses and treatments given by first aiders will help to identify trends. If an accident happens, find out what happened and why. Minor accidents and 'near misses' can give an early warning of more serious problems. Consider whether the accident would have happened if the work had been better planned or managed or employees had been better trained. Could site or company rules have been clearer or could plant and equipment have been better maintained? Don't just put the blame on human error or other people without thinking **why** the error was made.

572 Appendix 2 contains a basic checklist that identifies some of the hazards most commonly found on construction sites. It is not an exhaustive list but is intended to help you decide whether your site is a safe and healthy place to work.

## 4: Health and safety management and the law

573 All work activities are covered by health and safety law. The law which is most relevant to construction health and safety is set out here.

### The Health and Safety at Work etc Act 1974<sup>43</sup>

574 This Act applies to all work activities. It requires employers to ensure, so far as reasonably practicable, the health and safety of their employees, other people at work and members of the public who may be affected by their work.

575 Employers should have a health and safety policy. If they employ five or more people, the policy should be in writing. Use the advice in this book to draw up a policy. Keep the policy clear and simple. Make sure everybody in the firm knows about and understands the health and safety systems which have been developed and that these systems directly relate to the operations of the company. The safety policy should cover three distinct aspects:

- a general statement of the company's health and safety policy. This announces the company's intent to have high standards of health and safety, what it intends to achieve and how it intends to achieve it;
- the organisation for carrying out the policy, including reference to the management systems and safety representatives. It should include who is responsible for what and when and how they will achieve it; and
- the specific arrangements that the company operates for managing health and safety during its normal work activities. It should cover, where relevant, the activities addressed in Section 3 and how the considerations addressed in Section 2 (such as emergency procedures, provision of welfare facilities, accident reporting, site induction etc) will be managed.

576 The self-employed should ensure, so far as reasonably practicable, their own health and safety and make sure that their work does not put other workers or members of the public at risk.

577 Employees have to co-operate with their employer on health and safety matters and not do anything that puts themselves or others at risk (see paragraphs 663-667). Employees should be trained and clearly instructed in their duties.

### **The Management of Health and Safety at Work Regulations 1999**

578 The Management of Health and Safety at Work Regulations 1999 (MHSWR) apply to everyone at work, regardless of what that work is. They require employers to plan, control, organise, monitor and review their work.

579 To do this they should:

- assess the risks associated with work to identify the control measures necessary to reduce these risks;
- have access to competent health and safety advice;
- provide health and safety information and training to employees;
- have arrangements to deal with serious and imminent danger; and
- co-operate in health and safety matters with others who share the workplace.

### **Risk assessment**

580 Employers and the self-employed must identify the hazards involved with their work, assess the likelihood of any harm arising and decide on adequate precautions. This process is called risk assessment and is central to all planning for health and safety.

581 Risk assessment can be carried out in the five stages listed below. It is recommended that employers and the self-employed carry out their own risk assessments as they know their own industry, their own company and the risks that their employees face. What is important is that those carrying out risk assessments understand the requirements of the Regulations and possess the knowledge and judgement to ensure the most suitable precautionary measures are put into practice.

582 The risk assessment can either be carried out on a single specific task, or on the job as a whole, providing it is not too big. The assessment may highlight the need for specific assessments (such as manual handling, COSHH or noise) to be undertaken.

### *How is a risk assessment carried out?*

#### *Step 1: Look for the hazards*

583 Consider the job, how it will be done, where will it be done and what equipment, materials and chemicals will be used.

584 What are the hazards that could cause harm? Here are some examples that are regular causes of serious and fatal accidents or ill health:

- falling from an open edge or through a fragile surface;
- being struck by site vehicles;
- collapse of an excavation or part of a structure;
- use of a vibrating hand tool;
- work with materials (eg lead, asbestos or solvents) that could be a health problem;
- dust from cutting, grinding or drilling.

585 The most common construction hazards are identified in Section 3.

#### *Step 2: Decide who might be harmed and how*

586 Think about employees, the self-employed, employees of other companies working on the job, site visitors and members of the public who may be in the area or outside the site.

587 Safe working often depends on co-operation between firms. Consider how they need to be taken into account in the assessment. Identify problems the work may cause for others at the site, or problems they may cause for those doing the work and agree necessary precautions. Tell the principal contractor or whoever is controlling the site what has been agreed.

#### *Step 3: Evaluate the risks and decide on action*

588 Where there is a risk that someone could be harmed consider:

- **First:** Can the hazard be removed completely? Could the job be done in another way or by using a different, less hazardous, material? If it can, change the job or process to eliminate the risk.
- **Second:** If the risk cannot be eliminated, can it be controlled? Applying the advice and guidance given in Section 3 will help here. For example, while it may be necessary to apply a solvent-based material, the exposure of workers to hazardous vapours may be reduced by applying it by brush or roller rather than by spraying. If the precautions described in Section 3 have not been taken, is there an equivalent or better standard of protection? If not, more needs to be done.
- **Third:** Can measures be taken which will protect the whole workforce? For example, to prevent falls, guard rails at edges provide safety for everyone in the area.
- **Fourth:** Can the number of people at risk be reduced? For example, by reducing the size of the site workforce while cranes are in use for erecting structural frames etc, or by undertaking higher-risk tasks outside normal site working hours when only essential personnel will be present.



***Step 4: Record the findings***

589 Employers with five or more employees should record the significant findings of their assessment as an aid to controlling hazards and risks. No specific form is required providing that the information is recoverable.

590 Employers should pass on information about significant risks and the steps they have taken to control the risks, even when they employ less than five people.

***Step 5: Review the findings***

591 Reviews are important. They take account of unusual conditions on some sites and changes in the way the job is done. Reviews allow lessons learned from experience to be taken into account. A new assessment is not always needed for every job, but if there are major changes, a new assessment will be needed. In other cases only the principal contractor will be in a position to do a full assessment. For example, it may be the potential interaction of two or more contractors that leads to increased risk; in such cases the principal contractor should take the lead.

***Method statements***

592 Method statements are not required by law, but they have proved to be an effective and practical management tool. They can take account of risks identified by the risk assessment and communicate the safe system of work to those undertaking it, especially for higher-risk complex or unusual work (eg steel and formwork erection, demolition or the use of hazardous substances). A method statement draws together the information compiled about the various hazards and the ways in which they are to be controlled for any particular job from the conclusions of the risk assessments.

593 A method statement also takes account of the company's health and safety organisation and training procedures and may include arrangements to deal with serious or imminent danger.

594 The method statement describes in a logical sequence exactly how a job is to be carried out in a safe manner and without risks to health, and includes all the control measures. This will allow the job to be properly planned and resourced with the appropriate health and safety resources needed for it. It can also provide information for other contractors working at the site about any effects the work will have on them and help the principal contractor to develop an overall health and safety plan for the construction phase of a project (see paragraphs 616-618).

595 If a similar operation is repeated, the statement will be similar from job to job. However, if circumstances change markedly, eg with demolition, the statement will need to be revised for each job.

596 The method statement is an effective way of providing information to employees about how they expect the work to be carried out and the precautions that should be taken. The most effective health and safety method statements often have a number of diagrams to make it clear how work should be carried out. Checking that the working methods set out in the statement are actually put into practice on site can also be a useful monitoring tool.

597 When reviewing the risk assessments, use the information from monitoring previous jobs and accident records and investigations. It will help to decide if adequate precautions are being applied.

### **Health and safety training and advice**

598 Employers are responsible for ensuring health and safety and must ensure that they have a competent source of advice. The person providing this advice may need extra training in health and safety to meet this responsibility properly. Sometimes it may be necessary to use external advisors.

599 As with all training, whether for managers or site workers, there is a need to identify:

- what they know already;
- what they need to know and what skills they need;
- how best to provide the extra knowledge and skills they need.

600 Employers can then decide whether to provide the training in-house, use an external training course or a consultant.

601 If there isn't adequate expertise in the company, further advice may be obtained from:

- the Construction Industry Training Board (CITB);
- employers' and trade organisations such as the Building Employers' Confederation (BEC), the Federation of Master Builders (FMB) and the Construction Federation;
- training and enterprise councils and local enterprise companies;
- local health and safety groups;
- insurance companies;
- suppliers – they must provide instructions on using machines, tools, chemicals etc and product data sheets. Also, containers often have helpful labels;
- safety magazines – they have useful articles and advertise safety products and services;
- the British Safety Council (BSC), the Royal Society for the Prevention of Accidents (RoSPA), the Institution of Occupational Safety and Health (IOSH) and many other independent companies and consultants run training courses – look in the telephone directory;
- HSE publishes a newsletter about new HSE publications, changes in the law and similar items of interest, and there is also a twice-yearly newsletter for the construction industry entitled *Site Safe News*;
- the HSE website: [www.hse.gov.uk/construction](http://www.hse.gov.uk/construction).

602 Workers must be trained in safe working practices. Employees cannot be relied upon to pick up safety training on the job from their workmates – they might simply be learning someone else's bad habits. Employers need to be sure of their employees' abilities before setting them to work and need to provide necessary training where it is required.

603 Foremen and supervisors play an important role in ensuring work is done correctly. They control the way in which work is carried out on site. This means they can and should ensure that work is safe. They also have an important role in passing on training and information to workers on site, such as with toolbox talks. However, they cannot do this properly unless they are trained in safe and healthy working practices.

604 As workers come to the United Kingdom from other countries, the possible lack of understanding of the English language presents significant communication problems. Effective steps must be taken so that workers who cannot speak English can work safely and without risks to their own health and safety or the health and safety of others who may be affected. Employers have a duty to provide employees with information and instructions that are comprehensive and relevant, and in a language they understand. This may mean engaging a bilingual supervisor who can give instructions, training and supervision in the appropriate language.

### The Construction (Design and Management) Regulations 1994<sup>2</sup>

605 The Construction (Design and Management) Regulations 1994 (CDM) require that health and safety is taken into account and managed throughout all stages of a project, from conception, design and planning through to site work and subsequent maintenance and repair of the structure.

#### *Who does CDM affect?*

606 CDM affects everyone who takes part in the construction process: the client, the designers and contractors. Where they apply, the Regulations require two additional roles to be fulfilled: the planning supervisor and the principal contractor. The Regulations also require the health and safety plan and the health and safety file to be produced.

#### *What does CDM require?*

607 CDM requires that everyone who can contribute to improving site health and safety plays their part. What each duty holder can do will vary from project to project. The efforts everyone makes should be proportional to the health and safety risks associated with the work and the difficulty of managing those risks. This means that if the project is complex and the risks are high, more effort is needed than if the project is relatively small or has lower risks.

#### *When does CDM apply?*

608 The Regulations apply to most common building, civil engineering and engineering construction work (see Figure 54). They do not apply to construction work where the local authority is the enforcing authority for health and safety purposes. This means that where work is not notifiable (see Figure 1) **and** is either:

- carried out inside offices, shops and similar premises where the construction work is done without interrupting the normal activities in the premises and without separating the construction activities from the other activities; or
- the maintenance or removal of insulation on pipes, boilers or other parts of heating or water systems; then it is not subject to the CDM Regulations.

609 Apart from this exception, the CDM Regulations apply to all design work carried out for construction purposes (including demolition and dismantling). If any site work requires design work, even for temporary works, the Regulations will apply to the design aspect even if the Regulations do not require the appointment of a planning supervisor or a principal contractor.

610 The CDM Regulations apply to **all demolition and dismantling work**, regardless of the length of time the work will take or the number of people undertaking it.

611 The Regulations also apply to other construction work unless:

- the work will last 30 days or less and involve less than five people on site at any one time; or
- the work is being done for a domestic client (that is someone who lives or will live in the premises where the work is being done). In this case only the duties to notify HSE and those placed on designers apply (see paragraphs 34-37 and 623-629). However, in some instances domestic clients may enter into an arrangement with a developer who carries on a trade, business or other activity. For example, a developer may sell domestic premises before the project is complete. The domestic client then owns the incomplete property, but the developer still arranges for the construction work to be carried out. In this case the CDM requirements apply to the developer.

#### **What is the health and safety plan?**

612 The health and safety plan develops with the project and has at least two distinct phases (the first is associated with design and planning of the project before tendering or contractor selection, the second is associated with the construction phase). The planning supervisor is responsible for seeing that the plan is started. The purpose of the plan is to ensure information relevant to health and safety is passed on to those who need it.

613 The **pre-construction-stage** health and safety plan may include:

- a general description of the work and details of project timescales;
- details of health and safety risks as far as they are known, including information that clients are required to provide about site-specific risks (eg asbestos or contaminated land etc), and designers about particular project risks they were unable to eliminate and the assumptions in broad terms they have made about precautions that will be taken;
- information required by possible principal contractors to allow them to identify the health and safety competences and resources they will need for the project;
- information on which to base a construction-phase health and safety plan.

614 The pre-construction-stage health and safety plan needs to be available to possible principal contractors at the start of selection or tendering procedures. It informs them of the health, safety and welfare matters they need to take into account when planning for site work. Often the necessary information will already be contained within existing documents (eg preliminary documents and design drawings). In these cases the plan can simply be an index to where the necessary information can be found within the other documents. Where this is not the case, a separate plan will be required containing the additional material.

615 The plan only needs to contain information that is specific to the project and is necessary to assist the development of safe systems of work. The plan does not need to repeat information that a competent contractor would already know. Including unnecessary or irrelevant material can make essential information more difficult to identify and reduce the effectiveness of the plan as a way of passing on information.

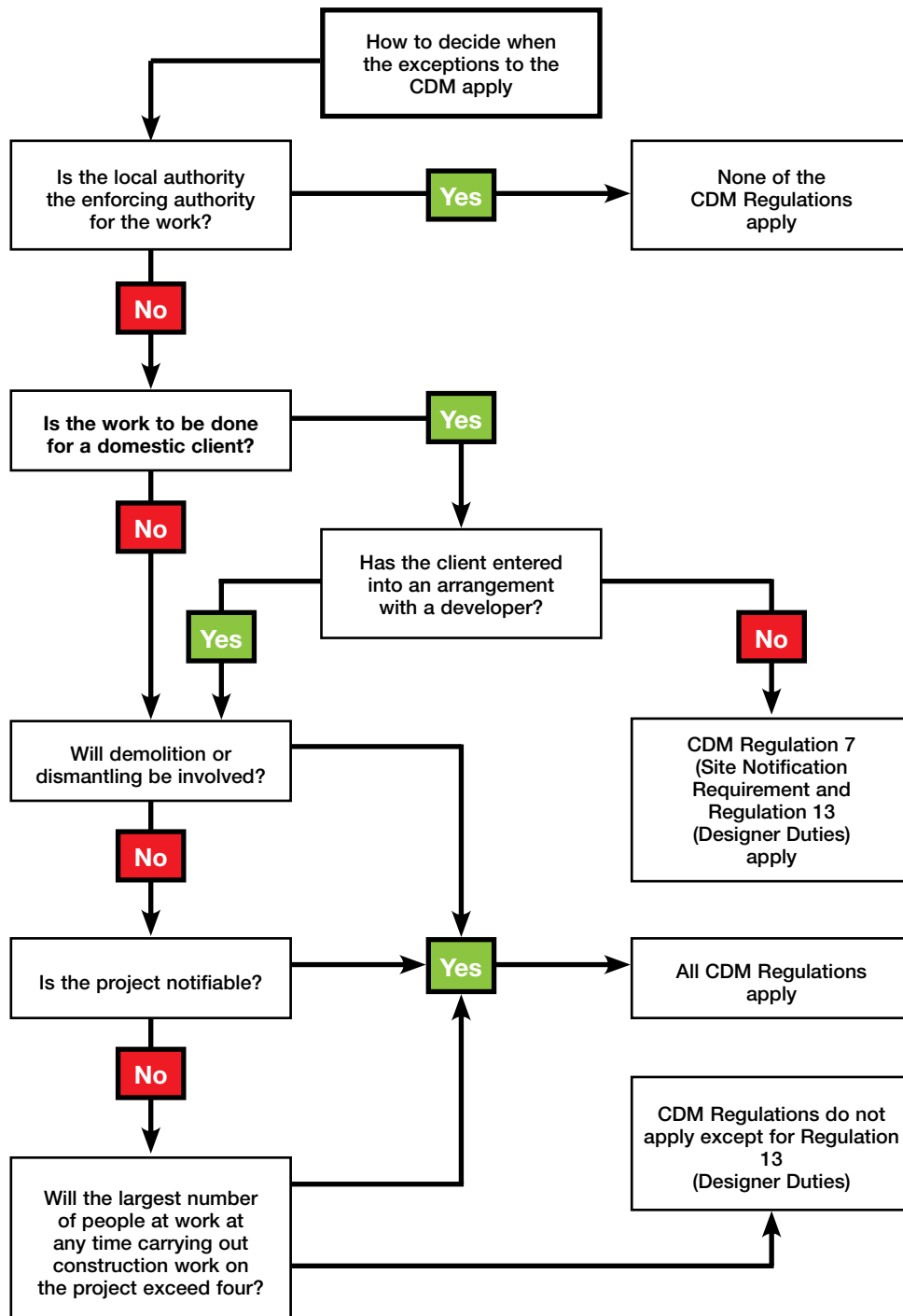

Figure 54 CDM decision tool

616 For the **construction phase**, the principal contractor develops the health and safety plan so that it addresses issues that are relevant to health, safety and welfare matters key to the project. Issues which need to be considered for inclusion in the plan include:

- how health and safety will be managed during the construction phase, including details of how information and instructions will be passed to contractors and how their activities will be co-ordinated;
- contractors' risk assessments and health and safety method statements for high-risk activities;
- information about welfare arrangements sufficient to allow contractors on the project to understand how they can comply with welfare requirements;
- common arrangements (eg on welfare, site hoardings and emergency procedures);
- how contractors, material suppliers and plant and equipment supplied for common use will be selected;
- how the views of workers and their representatives on health and safety issues associated with the project will be co-ordinated;
- information on necessary levels of health and safety training for those working on the project and arrangements for project-specific awareness training and refresher training such as toolbox talks;
- arrangements for monitoring compliance with health and safety law;
- site health and safety rules and relevant health and safety standards where appropriate, particularly where standards above the minimum statutory requirement are requested by the client;
- procedures for delivering information for the health and safety file.

617 The extent to which particular items need to be addressed within the plan will depend on the degree of risk associated with the project and how much coverage has been given to issues in other documents (eg contract preliminaries and contractor health and safety policies). Where the risk is low and issues are covered in the principal contractor's health and safety policy, a simple reference to the safety policy arrangements may be sufficient.

618 The plan should be developed as far as possible before construction work starts, and then reviewed as necessary to account for changing project circumstances.

On many larger projects design may not be complete. In these cases the construction-phase plan will need to address:

- the general management arrangements (eg who will be responsible for management, how many supervisors will be needed at different stages, how information will be passed to contractors, how method statements will be agreed etc);
- welfare arrangements and how they will be provided and maintained;
- procedures for site security;
- details of work early in the project for which information is available, explaining how it will be managed and controlled; and
- how new design information will be handled and incorporated into the plan.

#### **What is the health and safety file?**

619 This is a record of information for the client or end user. The planning supervisor ensures it is produced at the end of the project and is then passed to the client. It gives details of health and safety risks that will have to be managed during maintenance, repair, renovation or demolition. Contractors should pass information on these matters that becomes available during the construction phase to the planning supervisor for inclusion within the file. The client should make the file available to those who will work on any future design, construction, maintenance or demolition of the structure.

620 Details of how information for the file should be presented is best agreed with the client at an early stage. This will ensure that the information for the file can be gathered in a consistent manner and the file assembled and presented to the client in a way which will make it easy for the client to use. Files may also be electronically produced and stored; a paper copy is not required by law.

### ***What do the CDM Regulations require?***

#### ***The client***

621 The principal duties that are placed upon the client are to:

- appoint a planning supervisor and principal contractor for each project;
- take reasonable steps to satisfy themselves that the planning supervisor, principal contractor, project designers and any contractors they appoint directly are competent and adequately resourced to deal with health and safety problems associated with the project;
- obtain and pass on relevant information available to them about health and safety matters which relate to the project to those who are planning the project. If there is a health and safety file already available, relevant sections of this should be provided;
- ensure that construction work does not start unless a suitable health and safety plan has been prepared.

622 Clients may appoint agents to act on their behalf, but before doing so they should make reasonable enquiries to satisfy themselves that the agent is competent to fulfil the client's duties. This can be effected by sending a declaration to HSE.

#### ***The designer***

623 The term 'designer' includes everyone preparing drawings and specifications for the project. Designers include architects, structural engineers and surveyors. Before preparing any design, the designer should ensure that the client has been made aware of their own duties under the CDM Regulations.

624 Designers should ensure that when they design for construction work, they consider foreseeable health and safety risks during construction and eventual maintenance and cleaning of the structure in the balance with other design considerations, such as aesthetics and cost. They should apply the hierarchy of risk control. This means designers need to identify the hazards inherent in carrying out the construction work and where possible alter the design to avoid them. If the hazards cannot be removed by design changes, the designer should minimise the risks and provide information about the risks that remain.

625 The design should describe any matters that require particular attention by a contractor. Enough information should be provided to alert contractors and others to matters which they could not be reasonably expected to know about.

626 The designer should also consider in the same way how the structure can be maintained and repaired safely once built. Designers should do this when they develop almost any design, including design work for projects where the appointment of a planning supervisor or principal contractor is not required by the CDM Regulations.

627 Examples of what designers can do to improve health and safety might include:

- designing for non-fragile roofing assemblies instead of fragile ones (falls through fragile surfaces are a major cause of fatal and serious injuries);
- avoiding the need for chasing for cable runs (a job which inevitably exposes workers to high dust and noise levels) by embedding conduit within the wall finish;
- when designing foundations in contaminated land, specifying a driven-pile foundation (which does not bring contaminated material to the surface) instead of bored piles;
- avoiding concrete blocks weighing more than 20 kg (these are difficult to lift and are likely to lead to long-term back injury to block layers).

628 Designers should co-operate with the planning supervisor and other designers on health and safety matters and supply relevant information. Where CDM applies, information can be passed via the planning supervisor; where CDM does not apply, it should be supplied as part of the design information provided to the contractors. The information should include:

- the principles of the design relevant to the health and safety of those working on the project (eg erection sequences which must be followed to ensure stability);
- descriptions of special requirements for safe working (eg temporary propping of unstable structures);
- any special assumptions the designer has made about working practices (eg the site will have been levelled before structural erection begins to allow the safe use of MEWPs for access for erectors).

629 If a company or an individual provides any sort of design service to the client or others, or designs temporary works, regulation 13 will apply.

#### *The planning supervisor*

630 The planning supervisor is appointed by the client. The role of planning supervisor may be taken on by a company or an individual. The function can be discharged within the client's organisation, within the design or construction team. Alternatively, it can be done by some other independent person, partnership or organisation. The role is to:

- co-ordinate health and safety during the design and planning phase of the project;
- ensure that the pre-construction-stage health and safety plan for the project is produced in time for it to be provided to bidding contractors as part of the selection process;
- give advice about health and safety competence and resources needed for the project;
- ensure that written notice of the project is given to HSE;
- collect information for inclusion in the health and safety file, which they ensure is prepared before passing it to the client on completion of the contract.

631 CDM does not require planning supervisors to visit the site or to assess the performance of the principal contractor once construction work has begun.

#### *The principal contractor*

632 The principal contractor is appointed by the client to plan, manage and control health and safety during the construction phase of the project.



633 Site work should not start until the principal contractor has developed a construction-phase health and safety plan based upon information provided in the pre-construction health and safety plan. The plan may need to be developed during the construction phase to take account of changing conditions on site as work progresses or the design changes.

634 When planning the job, the principal contractor will need to identify the hazards and assess the risks of the job. To do this properly, information (including method statements and risk assessments) may be needed from other contractors who will be working at the site.

635 When risks arise because of potential interactions between contractors (eg site transport matters) or a number of contractors are exposed to a common risk (eg from the site electrical distribution system), the principal contractor should take a positive role in ensuring the general principles of risk prevention and control are applied.

636 The principal contractor's health and safety plan should take account of the general issues in Section 2, the specific hazards and risk control measures in Section 3 and the general principles of risk assessment in this section (paragraphs 580-591).

#### ***Contractors***

637 These are the firms or self-employed people working at the site. They should help the principal contractor to achieve safe and healthy site conditions by following their instructions. They should co-operate with other contractors working on the site and provide health and safety information (including risk assessments – see paragraphs 580-591) to the principal contractor.

638 For those contractors who work on larger sites where CDM applies, asking about the project health and safety plan before starting work will be valuable. Employees need to be told what it says that affects them. Proposed working methods should fit in with the plan and with site rules. If they do not, tell the principal contractor.

#### ***Health and safety competence***

639 Everyone letting or subletting contracts is expected to take steps to satisfy themselves that the people who will do the work are competent. This can be done by asking questions such as:

- whether the contractor employs a safety advisor or uses the services of a safety consultant, and how often the safety advisor will visit the job;
- whether the contractor has done this type of work previously;
- what the contractor's safety statistics are in respect of injuries, near misses and dangerous occurrences;
- whether they have been issued with any improvement or prohibition notices or been prosecuted (this information is available on the HSE website for limited companies, partnerships and sole traders); and
- whether it is their intention to use subcontractors and if so, for what elements of the job and how will the subcontractor be selected and managed.

640 CDM requires that anyone letting or subletting contracts must also satisfy themselves that those who are to do the work are:

- competent in relevant health and safety issues; and
- intend to allocate adequate resources, including time, equipment and properly trained workers to do the job safely and without risks to health.

641 Ask the planning supervisor for their advice and input during the selection process.

642 The pre-construction-stage health and safety plan should act as a guide to the significant health and safety issues associated with the project. When tendering for work, being able to answer questions on these subjects will help designers and contractors to demonstrate competence and their suitability for the job.

643 If a client is letting work, or a builder or contractor is subletting work, considering the issues in this Section and Sections 2 and 3 will help them to decide on relevant questions to ask when assessing competence. Decide in advance what competences will be needed to do the work safely and without risk to health and how these can be demonstrated.

### **The Construction (Health, Safety and Welfare) Regulations 1996<sup>45</sup>**

#### ***Who has duties under the Regulations?***

644 The main duty holders under these Regulations are employers, the self-employed and those who control the way in which construction work is carried out. Employees also have duties to carry out their own work in a safe way. Also, anyone doing construction work has a duty to report any health or safety defects to those in control and to co-operate with others on matters of health and safety.

#### ***What do the Regulations cover?***

645 The Regulations cover a wide range of health and safety issues, including:

- welfare requirements such as toilets, washing facilities and rest areas;
- the support and inspection of excavations;
- transport routes and pedestrian segregation;
- provisions for higher-risk trades such as demolition; and
- emergency and fire procedures.

646 Much of the advice in Sections 2 and 3 of this book is relevant to these Regulations.

### **The Work at Height Regulations 2005<sup>1</sup>**

647 These Regulations place duties on employers, the self-employed, employees and those who control the way in which work at height is carried out. They cover all circumstances where a person is working at height (both above and below ground) or gaining access to/egress from a place of work and could fall any distance liable to cause personal injury.

648 The key provisions of the Regulations are that duty holders should:

- **avoid** work at height where they can;
- use work equipment to **prevent** falls where work at height cannot be avoided;
- where the risk of a fall cannot be eliminated, use work equipment to **minimise** the distance and consequences of a fall should one occur;
- always use measures which afford protection to everyone at risk (eg nets) before using personal protective measures (eg harnesses);
- ensure that the work is risk-assessment based and that the most suitable item of work equipment is selected and used;
- ensure those involved in work at height, including its planning and organisation, are competent to the level required to carry out their duties safely;
- inspect working platforms and work equipment at defined intervals and record the results (see Appendix 1);
- control risks from work involving fragile surfaces.

649 Section 3 covers the requirements of these Regulations in more detail.

### The Construction (Head Protection) Regulations 1989<sup>40</sup>

650 These Regulations specify when head protection should be worn. Further information can be found in paragraphs 531-535.

### The Lifting Operations and Lifting Equipment Regulations 1998<sup>10</sup>

651 These Regulations cover the operation of all lifting equipment including those that lift people. General advice on compliance can be found in the section entitled *Moving, lifting and handling loads*. Information on the Regulations can be found in *Safe use of lifting equipment. Lifting Operations and Lifting Equipment Regulations 1998: Approved code of practice and guidance*.<sup>12</sup>

### The Provision and Use of Work Equipment Regulations 1998<sup>46</sup>

652 These Regulations cover all types of work equipment and deal with such issues as dangerous parts of machinery, roll over protections, visibility, and inspection. For further information read *Safe use of work equipment. Provision and Use of Work Equipment Regulations 1998. Approved Code of Practice and guidance*.<sup>47</sup>

### The Control of Substances Hazardous to Health Regulations 2002<sup>16</sup> (COSHH)

653 COSHH requires employers to control exposure to hazardous substances to prevent ill health. They must protect both employees and others who may be affected. COSHH is a useful tool of good management that sets eight basic measures (listed below) that employers and sometimes employees must take. It requires a step-by-step approach during which you are required to assess risks and implement any measures needed to control exposure and establish good working practices.

654 What COSHH requires:

- Step 1: **Assess the risks** to health arising from hazardous substances used or created by your workplace activities.
- Step 2: **Decide what precautions are needed.** You must not carry out work which could expose your employees to hazardous substances without first considering the risks and the necessary precautions and what else you need to do to comply with COSHH.
- Step 3: **Prevent or adequately control exposure.** You must prevent your employees being exposed to hazardous substances. Where preventing exposure is not reasonably practicable, then you must adequately control it.
- Step 4: **Ensure that control measures are used and maintained** properly and that safety procedures are followed.
- Step 5: **Monitor the exposure** of employees to hazardous substances if necessary.
- Step 6: **Carry out appropriate health surveillance** where your assessment has shown this is necessary or where COSHH sets specific requirements.
- Step 7: **Prepare plans and procedures** to deal with accidents, incidents and emergencies involving hazardous substances where necessary.
- Step 8: **Ensure employees are properly informed, trained and supervised.**

655 Further information can be found in the *COSHH Approved Code of Practice and guidance*.<sup>19</sup>

### The Manual Handling Operations Regulations 1992<sup>11</sup>

656 These Regulations apply to a wide range of manual handling activities involving the transporting or supporting of a load. This includes lifting, lowering, pushing, pulling, carrying or moving. They require employers to avoid the need for hazardous manual handling but where this need cannot be avoided, employers must assess the risk of injury and take measures to reduce it. Employees also have duties to follow appropriate systems of work, make proper use of the equipment provided for their safety and to inform their employer if they identify any hazardous handling activities.

657 For further information read *Manual handling. Manual Handling Operations Regulations 1992 (as amended). Guidance on Regulations*.<sup>48</sup>

### The Control of Noise at Work Regulations 2005<sup>29</sup>

658 The Noise Regulations require employers to assess the risks to employees from noise at work and take action to prevent or reduce the noise exposure that produces those risks. If the noise exposure cannot be reduced sufficiently using other methods, hearing protection must be provided. Employers must provide employees with information, instruction and training and carry out health surveillance where necessary.

659 These Regulations require employers to take specific action at certain action values. The action values relate to:

- the levels of your employees' exposure to noise averaged over a working day or week (lower action value 80 dB, upper action value 85 dB); and
- the maximum noise (peak sound pressure) to which employees are exposed in a working day (lower action value 135 dB, upper action value 137 dB).

660 The actions you are required to take and further guidance can be found in *Controlling noise at work. The Control of Noise at Work Regulations 2005. Guidance on Regulations.*<sup>49</sup>

### **The Control of Vibration at Work Regulations 2005<sup>31</sup>**

661 The Control of Vibration at Work Regulations require employers to:

- assess the vibration risk to their employees;
- decide if they are likely to be exposed above the daily exposure action value (EAV) and if they are, introduce a programme of controls to eliminate risk or reduce exposure to as low a level as is reasonably practicable;
- decide if they are likely to be exposed above the daily exposure limit value (ELV) and take immediate action to reduce their exposure below it;
- provide information and training to employees on health risks and the actions you are taking to control those risks;
- keep a record of the risk assessment and update it regularly;
- keep health records for employees under health surveillance.

662 The actions you are required to take and further guidance can be found in *Hand-arm vibration. The Control of Vibration at Work Regulations 2005. Guidance on Regulations.*<sup>33</sup>

### **Employees' duties**

663 Employees also have health and safety duties. They should:

- follow instructions given to them by their supervisors;
- co-operate with their employer on health and safety matters;
- follow the health and safety rules that apply to their particular job and to the site in general;
- use the health and safety equipment provided;
- report defects in equipment to their supervisor;
- take care of their own health and safety as well as that of their workmates and others who might be affected by their work.

664 Employees should be trained to know what to do and the work should be supervised and monitored to make sure that information provided as training is relevant to the work situation and is applied effectively.

665 Deciding whether somebody is an employee or is self-employed can be complex in the construction industry. It may be important to be sure of the employment status of people working on a site. It may affect who has responsibility for some aspects of health and safety and the provision of safety equipment such as boots and hats.

666 Remember, just because someone pays their own tax and insurance it does not necessarily mean that they are self-employed under health and safety law. Deciding who is an employee depends on a range of issues. A person is more likely to be an employee when the following apply:

- they work continuously or regularly for the same person or company;
- they are paid an hourly rate;
- they are not allowed to subcontract work;
- they can be told by another (their employer) when, how and where they are to work;
- tools and materials are provided for them;
- the person has not entered into a contract for a fixed sum for a package of work.

667 However, these tests are not always certain and legal advice may be needed to be sure of the situation. Where anyone is employed, cover will be needed under the Employers' Liability (Compulsory Insurance) Act 1969.<sup>50</sup> The current certificate should also be displayed by the employer.

### Reporting accidents and work-related diseases

668 The Reporting of Injuries, Diseases and Dangerous Occurrences Regulations 1995<sup>7</sup> (RIDDOR) require that certain types of accidents, specific cases of occupational ill health and some dangerous occurrences have to be reported to the:

HSE Incident Contact Centre  
Caerphilly Business Park  
Caerphilly CF83 3GG  
Website: [www.riddor.gov.uk](http://www.riddor.gov.uk)  
Telephone: 0845 300 9923  
Fax: 0845 300 9924  
e-mail: [riddor@natbrit.com](mailto:riddor@natbrit.com)

669 Employers must report accidents to their employees. Whoever is in control of the site must also report accidents involving a self-employed worker or member of the public. Any of the following types of accident which happen on site have to be reported:

- serious and fatal accidents must be notified without delay to HSE, normally by telephone;
- this must be followed up with a completed accident report form (F2508) within ten days;
- for less serious injuries, where the injured person is unfit (or unable) to do their normal job for more than three consecutive days, a completed accident report form F2508 must be sent to HSE within ten days;
- if a dangerous occurrence happens on site, eg a building, scaffold or falsework collapse, failure of a crane or lifting device or contact with overhead lines, it must be reported immediately, normally by telephone, to the nearest HSE office. The details must be confirmed within ten days on a completed accident report form (F2508);
- if a worker suffers from a specified disease associated with their current job, eg hand-arm vibration syndrome and some forms of dermatitis, it must be reported to HSE on a completed disease report form (F2508A).

670 The forms referred to are available at [www.hse.gov.uk](http://www.hse.gov.uk), or from your local HSE office.

671 If a principal contractor has been appointed, contractors should promptly provide them with details of accidents, diseases or dangerous occurrences that are reportable or notifiable under RIDDOR.

### **Keeping records**

672 A record must be kept of any reportable injury, disease or dangerous occurrence. This must include the date and method of reporting, the date, time and place of the event, personal details of those involved and a brief description of the nature of the event or disease. The record can be kept in any form preferred, eg keep copies of completed report forms in a file.

673 Further details on how to report accidents and what types of accident must be reported can be found in *RIDDOR explained*.<sup>51</sup>

### **Inspectors and the law**

674 Health and safety laws that apply to construction companies are usually enforced by an inspector from HSE. However, some smaller jobs inside offices, shops and similar premises are the responsibility of inspectors from the local authority.

675 One of the jobs of health and safety inspectors is to see how well site hazards are being dealt with, especially the more serious ones that could lead to injuries or ill health. They may wish to investigate an accident or a complaint.

676 Inspectors do visit workplaces without notice but everyone is entitled to see their identification before letting them look around. Don't forget that they are there to give help and advice, particularly to smaller firms that may not have a lot of knowledge. When they do find problems they will try to deal with the firm in a reasonable and fair way. If anyone is not satisfied with the way they have been treated, they can take the matter up with the inspector's manager, whose name is on all letters from HSE. Any complaint about HSE inspectors will be investigated, and firms will be told what is to be done to put things right if a fault is found.

677 Inspectors do have wide powers, which include the right of entry to premises, the right to talk to employees and safety representatives and to take photographs and samples. They are entitled to workers' co-operation and answers to questions. They have the right to take written statements from anyone who can help them with their investigation.

678 If there is a problem, they have the right to issue a notice requiring improvements to be made or (where a risk of serious personal injury exists) one which stops a process or the use of dangerous equipment. If a business receives an improvement or prohibition notice, it has the right to appeal to an industrial tribunal. If the business appeals against an improvement notice, the action required by the notice is suspended until the appeal is finished. The action required by a prohibition notice is not suspended pending an appeal because that could allow a serious risk to persist.

679 Inspectors do have the power to prosecute a business or an individual for breaking health and safety law, but they will take their attitude and safety record into account.

680 If an inspector:

- tells you to do something, you have a right, if you ask, to be given a letter explaining what needs to be done, when and why;
- intends to take immediate action (eg by issuing a prohibition notice), you have a right to a written explanation as soon as practicable of why this is necessary. Prohibition notices include such explanation;
- intends to issue an improvement notice, you have a right to a written explanation of what is wrong, an outline of what needs to be done, and by when.

681 When a notice is issued, you will be told about your right of appeal to an industrial tribunal. A form will be sent to you which explains:

- how to appeal;
- where and within what period an appeal may be brought;
- that an appeal may be brought on any grounds; and
- that action required by an improvement notice is suspended while an appeal is pending.



# Appendix 1: Inspection recording form with timing and frequency chart

## Timing and frequency chart

Place of work or work equipment	Timing and frequency of checks, inspections and examinations								
	Inspect before work at the start of every shift (see note 1)	Inspect after any event likely to have affected its strength or stability	Inspect after accidental fall of rock, earth or other material	Inspect after installation or assembly in any position (see notes 2 and 3)	Inspect at suitable intervals	Inspect after exceptional circumstances which are liable to jeopardise the safety of work equipment	Inspect at intervals not exceeding 7 days (see note 3)	Check on each occasion before use (REPORT NOT REQUIRED)	LOLER Thorough Examination (if work equipment subject to LOLER) (see note 4)
Excavations which are supported to prevent any person being buried or trapped by an accidental collapse or a fall or dislodgement of material	✓	✓	✓						
Cofferdams and caissons	✓	✓							
The surface and every parapet or permanent rail of every existing place of work at height							✓		
Guard rails, toe boards, barriers and similar collective means of fall protection				✓	✓	✓			
<b>Scaffolds and other working platforms (including tower scaffolds and MEWPs) used for construction work and from which a person could fall more than 2m</b>				✓		✓	✓		✓
All other working platforms				✓	✓	✓			✓
Collective safeguards for arresting falls (eg nets, airbags, soft landing systems)				✓	✓	✓			
Personal fall protection systems (including work positioning, rope access, work restraint and fall arrest systems)				✓	✓	✓			✓
Ladders and stepladders					✓	✓		✓	

### Notes

- 1 Although an excavation must be inspected at the start of every shift, only one report is needed in any seven-day period. However, if something happens to affect its strength or stability, and/or an additional inspection is carried out, a report must then be completed. A record of this inspection must be made and retained for three months.
- 2 'Installation' means putting into position and 'assembly' means putting together. You are not required to inspect and provide a report every time a ladder, tower scaffold or mobile elevated work platform (MEWP) is moved on site or a personal fall protection system is clipped to a new location.
- 3 An inspection and a report is required for a tower scaffold or MEWP (used for construction work and from which a person could fall 2 metres) after installation or assembly and every seven days thereafter, providing the equipment is being used on the same site. A record of this inspection must be made and retained for three months. If a tower scaffold is reassembled rather than simply moved, then an additional, pre-use inspection and report is required. It is acceptable for this inspection to be carried out by the person responsible for erecting the tower scaffold, providing they are trained and competent. A visible tag system, which supplements inspection records as it is updated following each pre-use inspection, is a way of recording and keeping the results until the next inspection.
- 4 All work equipment subject to LOLER regulation 9, thorough examination and inspection requirements, will continue to be subject to LOLER regulation 9 requirements.

**INSPECTION REPORT**

1. Name and address of person for whom inspection was carried out.

2. Site address.

3. Date and time of inspection.

4. Location and description of place of work or work equipment inspected.

5. Matters which give rise to any health and safety risks.

6. Can work be carried out safely?

**Y / N**

7. If not, name of person informed.

8. Details of any other action taken as a result of matters identified in 5 above.

9. Details of any further action considered necessary.

10. Name and position of person making the report.

11. Date and time report handed over.

12. Name and position of person receiving report.

## Appendix 2: Construction health and safety checklist

- 1 This checklist identifies some of the hazards most commonly found on construction sites. The questions it asks are intended to help you decide whether your site is a safe and healthy place to work. It is not an exhaustive list. More detailed information can be found in other HSE publications.
- 2 A range of plant and equipment (eg scaffolds, cranes, hoists, electrical equipment and excavations) needs to be inspected on a regular basis by a competent person to ensure safety. Records of some inspections are also required to be made and kept. Further details can be found in Section 3.
- 3 Regular inspection is important but it is also essential that when defects are identified by the inspection or reported by people using the equipment, either the defects are remedied immediately or work is stopped until necessary repairs are completed.

### Access on site

- Can everyone get to their place of work safely?
- Are access routes free from obstructions and clearly signposted?
- Are holes protected with clearly marked and fixed covers to prevent falls?
- Are temporary structures stable, adequately braced and not overloaded?
- Will permanent structures remain stable during any refurbishment or demolition work?
- Is the site tidy, and are materials stored safely?
- Is lighting adequate, especially when work is being carried on after dark outside or inside buildings?

### Welfare

- Are toilets readily available and are they kept clean and properly lit?
- Are there washbasins, hot and cold (or warm) running water, soap and towels?
- Are the washbasins large enough to wash up to the elbow and are they kept clean?
- Is there somewhere to change, dry and store clothing?
- Is there a place where workers can sit, make hot drinks and prepare food?
- Are drinking water and cups provided?
- Can everyone who needs to use them get to the welfare facilities easily and safely?

### Scaffolds

- Are scaffolds erected, altered and dismantled by competent people?
- Are all uprights provided with base plates (and where necessary, timber sole plates)?
- Are all uprights, ledgers, transoms and braces in position?
- Is the scaffold tied to the building or structure in enough places to prevent collapse?
- Are there double guard rails and toe boards or other suitable protection at every edge, to prevent falling?

- Are brick guards provided to prevent materials falling from scaffolds?
- Are the working platforms fully boarded and are the boards arranged to avoid tipping or tripping?
- Are there effective barriers or warning notices in place to stop people using an incomplete scaffold, eg where working platforms are not fully boarded?
- Is the scaffold strong enough to carry the weight of materials stored on it and are these evenly distributed?
- Does a competent person inspect the scaffold regularly, eg at least once a week if the working platform is 2 m or above in height or at suitable intervals if less than 2 m, and always after it has been altered or damaged and following extreme weather?
- Are the results of inspections recorded and kept?
- Have proprietary tower scaffolds been inspected and are they being used in accordance with suppliers' instructions?
- Have the wheels of tower scaffolds been locked and outriggers deployed when in use and are the platforms empty when they are moved?

### **Ladders**

- Does your risk assessment conclude that ladders are the right way to the job? Don't work from a ladder if there is a safer way using more suitable equipment!
- Are the ladders in good condition?
- Do ladders rest against a solid surface and not on fragile surfaces or insecure materials?
- Are they secured to prevent them slipping sideways or outwards?
- Do ladders rise a sufficient height above their landing place (about five rungs)? If not, are other handholds available?
- Are the ladders positioned so that users do not have to overstretch?

### **Roof work**

- Is there edge protection to stop people or materials falling?
- During industrial roofing, have nets been provided to stop people falling from the leading edge of the roof and from partially fixed sheets?
- Where nets are used, have they been rigged safely by a competent person?
- Have you identified fragile surfaces such as fibre cement sheets and roof lights?
- Have you taken precautions to stop people falling through fragile surfaces when working on the roof, eg by providing barriers, covers or working platforms?
- Are people kept away from the area below the roof work? If this is not possible, have additional precautions been taken to stop debris falling onto them?

### **Powered access equipment**

- Has the equipment been installed by a competent person?
- Are the operators trained and competent?
- Is the safe working load clearly marked?
- Is the equipment inspected by a competent person?
- Does the working platform of the powered access equipment have adequate, secure guard rails and toe boards or other barriers to prevent people and materials falling off?
- Have precautions been taken to prevent people being struck by:
  - the moving platform;
  - projections from the building; or
  - falling materials?

### **Traffic, vehicles and plant**

- Are vehicles and pedestrians kept apart? If not, do you:
  - Separate them as much as you can and use barriers?
  - Tell people about the problem, and what to do about it?
  - Display warning signs?
- Can zero tail swing excavators be used or is there adequate clearance around slewing vehicles?
- Can reversing be avoided, eg by using a one-way system, or if not, are properly trained signallers used?
- Are vehicles and plant properly maintained, eg do the steering lights, handbrake and footbrake work properly?
- Have drivers received proper training and are they competent for the vehicles or plant they are operating?
- Are loads properly secured?
- Have you made sure that passengers are only carried on vehicles designed to carry them?
- Have you made sure that plant and vehicles are not used on dangerous slopes?

### **Hoists**

- Has the equipment been installed by a competent person?
- Are the operators trained and competent?
- Is the rated capacity clearly marked?
- Are the hoists inspected by a competent person?
- Does the hoist have a current report of thorough examination and a record of inspection?
- Is there a suitable base enclosure to prevent people from being struck by any moving part of the hoist?
- Are the landing gates kept shut except when the platform is at the landing?
- Are controls arranged so that the hoist can be operated from one position only?

### **Cranes**

- Is the crane suitable for the job?
- Has the lift been properly planned by an 'appointed person'?
- Is the crane on a firm, level base? Are the riggers properly set?
- Who is the appointed 'crane supervisor' responsible for controlling the lifting operation on site?
- Are the crane driver and signaller trained and competent?
- Is the load secure?
- Has the signaller/slinger been trained to give signals and to attach loads correctly?
- Have you made arrangements to make sure the driver can see the load or has a signaller been provided to help?
- Are people stopped from walking or working beneath a raised load?
- Does the crane have a current report of through examination and record of inspection?

### **Excavations**

- Is there adequate support for the excavation, or has it been sloped or battered back to a safe angle?
- Is there a safe method used for putting in the support, without people working in an unsupported trench?
- Is there safe access into the excavation, eg a sufficiently long, secured ladder?
- Are there barriers or other protection to stop people and vehicles falling in?
- Are properly secured stop blocks provided to prevent tipping vehicles falling in?
- Could the excavation affect the stability of neighbouring structures or services?
- Are materials, spoil and plant stored away from the edge of the excavation to reduce the chance of a collapse?
- Is the excavation regularly inspected by a competent person?

### **Manual handling**

- Are there heavy materials such as roof trusses, concrete lintels, kerbstones or bagged products which could cause problems if they have to be moved by hand? If so, can you:
  - choose lighter materials;
  - use wheelbarrows, hoists, telehandlers and other plant or equipment so that manual lifting of heavy objects is kept to a minimum;
  - order materials such as cement and aggregates in 25 kg bags; and/or
  - avoid the repetitive laying of heavy building blocks weighing more than 20 kg?
- Have people been instructed and trained how to lift safely?

### **Hazardous substances**

- Have you identified all harmful substances and materials, such as asbestos, lead, solvents, paints, cement and dust?
- Have you checked whether a licensed contractor is needed to deal with asbestos on site? (Most work with asbestos requires a licence, although you can do some very limited work with material that contains asbestos without one.)
- Have you identified and put into place precautions to prevent or control exposure to hazardous substances, by:
  - doing the work in a different way, to remove the risk entirely;
  - using a less hazardous material; or
  - using tools fitted with dust extraction?
- Have workers had information and training so they know what the risks are from the hazardous substances used and produced on site, and what they need to do to avoid the risks?
- Have you got procedures to prevent contact with wet cement (as this can cause both dermatitis and cement burns)?
- Have you arranged health surveillance for people using certain hazardous substances (eg lead)?

### **Noise**

- Have workers had information and training so they know what the risks are from noise on site, and what they need to do to avoid those risks?
- Have you identified and assessed workers' exposure to noise?
- Can the noise be reduced by using different working methods or selecting quieter plant, eg by fitting breakers and other plant or machinery with silencers?
- Are people not involved in the work kept away from the source of the noise?
- Is suitable hearing protection provided and worn in noisy areas?
- Have hearing protection zones been marked?
- Have you arranged health surveillance for people exposed to high levels of noise?

### **Hand-arm vibration**

- Have workers had information and training so they know what the risks are from hand-arm vibration (HAV) on site, and what they need to do to avoid those risks?
- Have you identified and assessed risks to workers from prolonged use of vibrating tools such as concrete breakers, angle grinders or hammer drills?
- Has exposure to HAV been reduced as much as possible by selecting suitable work methods and plant?
- Are reduced-vibration tools used whenever possible?
- Have vibrating tools been properly maintained?
- Have you arranged health surveillance for people exposed to high levels of hand-arm vibration, especially when exposed for long periods?

### **Electricity and other services**

- Have all necessary services been provided on site before work begins and have you also identified existing services present on site (eg electric cables or gas mains) and taken effective steps (if necessary) to prevent danger from them?
- Are you using low voltage for tools and equipment, eg battery-operated tools or low-voltage systems?
- Where mains voltage has to be used, are trip devices (eg residual current devices (RCDs)) provided for all equipment?
- Are RCDs checked daily by users and properly maintained?
- Are cables and leads protected from damage?
- Are all connections to the system properly made and are suitable plugs used?
- Are tools and equipment checked by users, visually examined on site and regularly inspected and tested by a competent person?
- Where there are overhead lines, has the electricity supply been turned off, or have other precautions been taken, such as providing 'goal posts' or taped markers?
- Have hidden electricity cables and other services been located (eg with a locator and plans) and marked, and have you taken precautions for safe working?

### **Confined spaces**

- Do you work in confined spaces where there may be an inadequate supply of oxygen or the presence of poisonous or flammable gas? If so, have you taken all necessary precautions?
- Confined spaces include tanks, sewers and manholes; they do not have to look dirty to be dangerous!

## Tools and machinery

- Are the right tools or machinery being used for the job?
- Are all dangerous parts guarded, eg gears, chains drives, projecting engine shafts?
- Are guards secured and in good repair?
- Are tools and machinery maintained in good repair and are all safety devices operating correctly?
- Are all operators trained and competent?

## Fires and emergencies

### General

- Are there emergency procedures, eg for evacuating the site in case of fire or for rescue from a confined space?
- Do people on site know what the procedures are?
- Is there a means of raising the alarm, and does it work?
- Is there a way to contact the emergency services from site?
- Are there adequate escape routes and are these kept clear?
- Is there adequate first-aid provision?

### Fire

- Is the quantity of flammable materials, liquids and gases on site kept to a minimum?
- Are they properly stored?
- Are suitable containers used for flammable liquids?
- Are flammable gas cylinders returned to a ventilated store at the end of the shift?
- Are smoking and other ignition sources banned in areas where gases or flammable liquids are stored or used?
- Are gas cylinders, associated hoses and equipment properly maintained and in good condition?
- When gas cylinders are not in use, are the valves fully closed?
- Is flammable and combustible waste removed regularly and stored in suitable bins or skips?
- Are suitable fire extinguishers provided?

## Protecting the public

- Is the work fenced off from the public?
- Are roadworks barriered off and lit, and a safe alternative route provided?
- Are the public protected from falling material?
- Have you provided a safe route through roadworks or pavement scaffolding for people with prams, wheelchair users and visually impaired people?
- When work has stopped for the day:
  - Is the boundary secure and undamaged?
  - Are all ladders removed or their rungs boarded so that they cannot be used?
  - Are excavations and openings securely covered or fenced off?
  - Is all plant immobilised to prevent unauthorised use?
  - Are bricks and materials safely stacked?
  - Are flammable or dangerous substances locked away in secure storage places?



# References and further information

## References

- 1 *Work at Height Regulations 2005* SI 2005/735 The Stationery Office 2005 ISBN 0 11 072563 8
- 2 *Construction (Design and Management) Regulations 1994* SI 1994/3140 The Stationery Office 1994 ISBN 0 11 043845 0
- 3 *Safe use of vehicles on construction sites: A guide for clients, designers, contractors, managers and workers involved with construction transport* HSG144 HSE Books 1998 ISBN 0 7176 1610 X
- 4 *Protecting the public: Your next move* HSG151 HSE Books 1997 ISBN 0 7176 1148 5
- 5 *Fire safety in construction work: Guidance for clients, designers and those managing and carrying out construction work involving significant fire risks* HSG168 HSE Books 1997 ISBN 0 7176 1332 1
- 6 *Health and Safety (First Aid) Regulations 1981* SI 1981/917 The Stationery Office 1981 ISBN 0 11 016917 4
- 7 *Reporting of Injuries, Diseases and Dangerous Occurrences Regulations 1995* SI 1995/3163 The Stationery Office 1995 ISBN 0 11 053751 3
- 8 *Preventing falls in scaffolding and falsework* SG4:05 National Access and Scaffolding Confederation 2005 ISBN 0 9549 5151 4
- 9 *Health and safety in roof work* HSG33 (Second edition) HSE Books 1998 ISBN 0 7176 1425 5
- 10 *Lifting Operations and Lifting Equipment Regulations 1998* SI 1998/2307 The Stationery Office 1998 ISBN 0 11 079598 9
- 11 *Manual Handling Operations Regulations 1992* SI 1992/2793 The Stationery Office 1992 ISBN 0 11 025920 3 (as amended)
- 12 *Safe use of lifting equipment. Lifting Operations and Lifting Equipment Regulations 1998. Approved Code of Practice and guidance* L113 HSE Books 1998 ISBN 0 7176 1628 2
- 13 *Health and safety in excavations: Be safe and shore* HSG185 HSE Books 1999 ISBN 0 7176 1563 4
- 14 *Avoiding danger from underground services* HSG47 (Second edition) HSE Books 2000 ISBN 0 7176 1744 0
- 15 *Surveying, sampling and assessment of asbestos-containing materials* MDHS100 HSE Books 2001 ISBN 0 7176 2076 X

- 16 *Control of Substances Hazardous to Health Regulations 2002* SI 2002/2677  
The Stationery Office 2002 ISBN 0 11 042919 2
- 17 *Control of Asbestos at Work Regulations 2002* SI 2002/2675 The Stationery  
Office 2002 ISBN 0 11 042918 4
- 18 *Control of Lead at Work Regulations 2002* SI 2002/2676 The Stationery Office  
2002 ISBN 0 11 042917 6
- 19 *Control of substances hazardous to health (Fifth edition). The Control of  
Substances Hazardous to Health Regulations 2002 (as amended). Approved  
Code of Practice and guidance L5 (Fifth edition) HSE Books 2005*  
ISBN 0 7176 2981 3
- 20 *A short guide to managing asbestos in premises* Leaflet INDG223(rev3) HSE  
Books 2002 (single copy free or priced packs of 10 ISBN 0 7176 2564 8)
- 21 *Working with asbestos in buildings* Leaflet INDG289 HSE Books 1999 (single  
copy free or priced packs of 10 ISBN 0 7176 1697 5)
- 22 *Asbestos (Licensing) Regulations 1983* SI 1983/1649 The Stationery Office  
1983 ISBN 0 11 037649 8 (as amended)
- 23 *Work with asbestos insulation, asbestos coating and asbestos insulating board.  
Control of Asbestos at Work Regulations 2002. Approved Code of Practice and  
guidance L28 (Fourth edition) HSE Books 2002* ISBN 0 7176 2563 X
- 24 *A guide to the Asbestos (Licensing) Regulations 1983 as amended. The  
Asbestos (Licensing) Regulations 1983. Guidance on Regulations L11  
(Second edition) HSE Books 1999* ISBN 0 7176 2435 8
- 25 *Working with asbestos cement* HSG189/2 HSE Books 1999  
ISBN 0 7176 1667 3
- 26 *Asbestos (Prohibitions) (Amendment) Regulations 1999* SI 1999/2373 The  
Stationery Office 1999 ISBN 0 11 085167 6
- 27 *Introduction to asbestos essentials: Comprehensive guidance on working with  
asbestos in the building maintenance and allied trades* HSG213 HSE Books  
2001 ISBN 0 7176 1901 X
- 28 *Asbestos essentials task manual: Task guidance sheets for the building  
maintenance and allied trades* HSG210 HSE Books 2001 ISBN 0 7176 1887 0
- 29 *Control of Noise at Work Regulations 2005* SI 2005/1643 The Stationery Office  
2005 ISBN 0 11 072984 6
- 30 *Noise in construction: Further guidance on the Noise at Work Regulations 1989*  
Leaflet INDG127(rev) HSE Books 1994 (single copy free)
- 31 *Control of Vibration at Work Regulations 2005* SI 2005/1093 The Stationery  
Office 2005 ISBN 0 11 0072767 3
- 32 *Hand-arm vibration: Advice for employees* Pocket card INDG296(rev1) HSE  
Books 2005 (single copy free or priced packs of 25 ISBN 0 7176 6118 0)
- 33 *Hand-arm vibration. The Control of Vibration at Work Regulations 2005.  
Guidance on Regulations L140* HSE Books 2005 ISBN 0 7176 6125 3

- 34 *Control the risks from hand-arm vibration: Advice for employers on the Control of Vibration at Work Regulations 2005* Leaflet INDG175(rev2) HSE Books 2005 (single copy free or priced packs of 10 ISBN 0 7176 6117 2)
- 35 *BS 7671: 2001 Requirements for electrical installations. IEE Wiring Regulations. Sixteenth edition* British Standards Institution ISBN 0 863 41373 0
- 36 *Electrical safety on construction sites* HSG141 HSE Books 1995 ISBN 0 7176 1000 4
- 37 *Avoidance of danger from overhead electric powerlines* General Guidance Note GS6 (Third edition) HSE Books 1997 ISBN 0 7176 1348 8
- 38 *Confined Spaces Regulations 1997* SI 1997/1713 The Stationery Office 1997 ISBN 0 11 064643 6
- 39 *Safe work in confined spaces. Confined Spaces Regulations 1997. Approved Code of Practice, Regulations and guidance* L101 HSE Books 1997 ISBN 0 7176 1405 0
- 40 *Construction (Head Protection) Regulations 1989* SI 1989/2209 The Stationery Office 1989 ISBN 0 11 098209 6
- 41 *Safety at street works and road works* Department of Transport Code of Practice The Stationery Office 1992 ISBN 0 11 551144 X
- 42 *New Roads and Street Works Act 1991 Ch22* The Stationery Office 1991 ISBN 0 10 542291 6
- 43 *Health and Safety at Work etc Act 1974 Ch37* The Stationery Office 1974 ISBN 0 10 543774 3
- 44 *Management of Health and Safety at Work Regulations 1999* SI 1999/3242 The Stationery Office 1999 ISBN 0 11 085625 2
- 45 *Construction (Health, Safety and Welfare) Regulations 1996* SI 1996/1592 The Stationery Office 1996 ISBN 0 11 035904 6
- 46 *Provision and Use of Work Equipment Regulations 1998* SI 1998/2306 The Stationery Office 1998 ISBN 0 11 079599 7
- 47 *Safe use of work equipment. Provision and Use of Work Equipment Regulations 1998. Approved Code of Practice and guidance* L22 (Second edition) HSE Books 1998 ISBN 0 7176 1626 6
- 48 *Manual handling. Manual Handling Operations Regulations 1992 (as amended). Guidance on Regulations* L23 (Third edition) HSE Books 2004 ISBN 0 7176 2823 X
- 49 *Controlling noise at work. The Control of Noise at Work Regulations 2005. Guidance on Regulations* L108 (Second edition) HSE Books 2005 ISBN 0 7176 6164 4
- 50 *Employers' Liability (Compulsory Insurance) Act 1969 Ch57* The Stationery Office 1969 ISBN 0 10 545769 8

- 51 *RIDDOR explained: Reporting of Injuries, Diseases and Dangerous Occurrences Regulations* Leaflet HSE31(rev1) HSE Books 1999 (single copy free or priced packs of 10 ISBN 0 7176 2441 2)

### **Further information**

For information about health and safety, or to report inconsistencies or inaccuracies in this guidance, visit [www.hse.gov.uk/](http://www.hse.gov.uk/). You can view HSE guidance online and order priced publications from the website. HSE priced publications are also available from bookshops.

British Standards can be obtained in PDF or hard copy formats from BSI:  
<http://shop.bsigroup.com> or by contacting BSI Customer Services for hard copies only Tel: 020 8996 9001 email: [cservices@bsigroup.com](mailto:cservices@bsigroup.com).

The Stationery Office publications are available from The Stationery Office,  
PO Box 29, Norwich NR3 1GN Tel: 0870 600 5522 Fax: 0870 600 5533  
email: [customer.services@tso.co.uk](mailto:customer.services@tso.co.uk) Website: [www.tsoshop.co.uk/](http://www.tsoshop.co.uk/) (They are also available from bookshops.) Statutory Instruments can be viewed free of charge at [www.legislation.gov.uk/](http://www.legislation.gov.uk/).